

Bridge number and Conway products

RYAN C BLAIR

In this paper, we give a structure theorem for c -incompressible Conway spheres in link complements in terms of the standard height function on S^3 . We go on to define the generalized Conway product $K_1 *_c K_2$ of two links K_1 and K_2 . Provided $K_1 *_c K_2$ satisfies minor additional hypotheses, we prove the lower bound $\beta(K_1 *_c K_2) \geq \beta(K_1) - 1$ for the bridge number of the generalized Conway product where K_1 is the distinguished factor. Finally, we present examples illustrating that this lower bound is tight.

57M25, 57M27, 57M50

1 Introduction

Bridge number is the fewest number of maxima in any projection of a link K . This classical invariant is denoted $\beta(K)$ and was introduced by Schubert in his paper [5] *Über eine Numerische Knoteninvariante*. Schubert proves that, given a composite knot K with summands K_1 and K_2 , the bridge number of K satisfies the following equation:

$$\beta(K) = \beta(K_1) + \beta(K_2) - 1.$$

The techniques used in this paper are inspired by Schultens' more modern and more elegant proof of the same equality [6].

The classical Conway sum and Conway product were originally defined in [1] as operations which received as input two tangle diagrams and produced as output a new tangle diagram. These original operations have inspired several related constructions. In [2], Lickorish studies a method of producing prime links by identifying together the boundaries of prime tangles. Scharlemann and Tomova's operation takes two links, evacuates untangles from the links' complements to form two tangles, and identifies together the boundaries of these two tangles to form a new link [4]. The definition of generalized Conway product used in this paper encapsulates the construction in [4]. By carefully choosing the two untangles and the gluing map, Scharlemann and Tomova showed the existence of a generalized Conway product which respects bridge surfaces. They go on to prove that the following inequality holds for such a product:

$$\beta(K_1 *_c K_2) \leq \beta(K_1) + \beta(K_2) - 1$$

However, it is also shown in [4] (via a construction by the author) that the above inequality is not always an equality, so a lower bound is needed.

The main goal of this paper is to present a lower bound on the bridge number of the generalized Conway product in terms of the bridge number of the factor links.

As an intermediary step to achieving this goal, we prove a structure theorem for c -incompressible Conway spheres. A sphere C embedded in S^3 which meets a link K transversely in four points is called a Conway sphere. Loosely speaking, C is worm-like if it is the boundary of a regular neighborhood of an arc in S^3 and meets K in exactly two points near each of the endpoints of this arc. A rigorous definition of worm-like will ultimately rely on how C is embedded with respect to h , the standard height function on S^3 . The definition of worm-like and a proof of the following structure theorem are presented in Section 5.

Theorem A *If C is a c -incompressible Conway sphere embedded in the complement of a link K in S^3 and bridge position for K is thin position, then there is an isotopy of C and K resulting in $h|_K$ having $\beta(K)$ maxima and C being worm-like.*

The main theorem appears below and is proven in Section 6. Also, in this section, we give the definition of generalized Conway product and distinguished factor.

Theorem B *If $K_1 *_c K_2$ is a generalized Conway product such that C is c -incompressible and bridge position for $K_1 *_c K_2$ is thin position, then $\beta(K_1 *_c K_2) \geq \beta(K_1) - 1$ where K_1 is the distinguished factor.*

In Section 7, we provide examples that show this lower bound is tight.

I am grateful to Martin Scharlemann for suggesting that I investigate the relationship between Conway products and bridge number and for many helpful conversations.

2 Definitions and preliminaries

In this paper, K will denote a tame, nonsplit link embedded in S^3 and $h: S^3 \rightarrow \mathbb{R} \cup \{-\infty, +\infty\}$ is a height function with level sets consisting of 2-spheres and two exceptional points corresponding to $+\infty$ and $-\infty$. We require that h restricts to a Morse function on K .

Definition 2.1 *If the maxima of $h|_K$ occur above all of the minima, then K is in bridge position. The fewest number of maxima of $h|_K$ over all embeddings of K is the bridge number of K , denoted $\beta(K)$.*

We will use the structure afforded us by the height function h to study a Conway sphere C in the complement of a link K in the following way. Let F_C be the singular foliation on the Conway sphere C induced by $h|_C$. A *saddle* is any leaf of this foliation homeomorphic to the wedge of two circles. By standard position, we can assume that all saddles of F_C are disjoint from K .

A detailed analysis of the embedding of C near a given saddle will be integral to the argumentation that follows. As such, we fix the following notation.

Any given saddle $\sigma = s_1^\sigma \vee s_2^\sigma$, lies in a level sphere $S_\sigma = h^{-1}(h(\sigma))$. Let D_1^σ be the closure of the component of $S_\sigma - s_1^\sigma$ that is disjoint from s_2^σ and D_2^σ be the closure of the component of $S_\sigma - s_2^\sigma$ that is disjoint from s_1^σ .

A subdisk D in F_C is monotone if its boundary is entirely contained in a leaf of F_C and the interior of D is disjoint from every saddle in F_C . In practice, we will use the term subdisk in a slightly broader sense, allowing $\partial(D)$ to be immersed in C , where if $\partial(D)$ is immersed, then $\partial(D)$ denotes the saddle. We say a monotone disk is *outermost* if its boundary is s_i^σ for some saddle σ and label the disk D_σ . Similarly, if s_i^σ bounds an outermost disk D_σ , we say σ is an outermost saddle. It is usually the case that only one of s_1^σ and s_2^σ is the boundary of an outermost disk, so, our convention is to relabel so that $\partial(D_\sigma) = s_1^\sigma$.

Suppose σ is an outermost saddle. S_σ cuts S^3 into two 3–balls. The one that contains D_σ is again cut by D_σ into two 3–balls B_σ and B'_σ . We chose the labeling of B_σ and B'_σ so that $\partial(B_\sigma) = D_1^\sigma \cup D_\sigma$.

We say σ is an *inessential saddle* if σ is an outermost saddle and D_σ is disjoint from K . An *n–punctured disk* denotes a disk embedded in S^3 that meets K transversely in exactly n points. An embedded simple closed curve in a Conway sphere C is *c–inessential* if it bounds a 1–punctured disk in C . Similarly, σ is a *c–inessential saddle* if σ is an outermost saddle and D_σ meets K exactly once.

We say a saddle σ in F_C is *standard* if there is a monotone disk E_σ such that $\partial(E_\sigma) = \sigma$. If σ is a standard saddle, A_σ is the 3–ball with boundary $E_\sigma \cup D_1^\sigma \cup D_2^\sigma$ that lies completely to one side of S_σ .

By general position arguments, we can assume every saddle σ in F_C has a bicollared neighborhood in C that is disjoint from K and all other singular leafs of F_C . The boundary of this bicollared neighborhood consists of three circles c_1^σ , c_2^σ , and c_3^σ where c_1^σ and c_2^σ are parallel to s_1^σ and s_2^σ respectively. We can assume c_1^σ , c_2^σ , and c_3^σ are level with respect to h and that c_1^σ and c_2^σ lie in the same level surface.

When there is no confusion as to which saddle we are referring, we will drop the superscripts and subscripts of σ . Figure 1 illustrates all of the terminology outlined above.

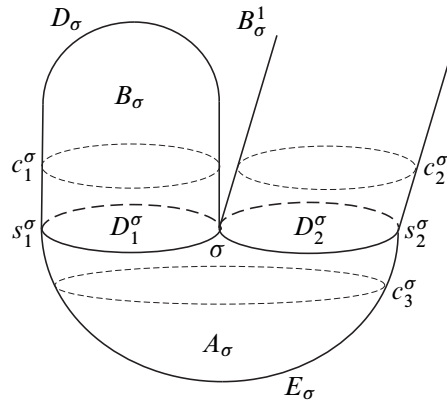

Figure 1

3 Conway spheres

Definition 3.1 Following [6], say a Conway sphere, C , is taut if the number of saddles in F_C is minimal subject to the condition that $h|_K$ has $\beta(K)$ maxima.

The goal of this section is to demonstrate the connection between the tautness of C and the existence of inessential and c-inessential saddles in F_C . Most of the results will be devoted to generalizing Schultens work on companion tori in link complements [6] to the case of Conway spheres. As we will see, the condition that C be taut precludes inessential saddles and some c-inessential saddles. In the following sections, we will assume additional hypotheses on the nature of bridge position of K and on the Conway sphere C . Under these additional hypotheses we will show that a taut Conway sphere has no inessential and no c-inessential saddles.

Lemma 3.2 and its proof are immediate generalizations of Schultens' Lemma 1 in [6]. We need alter the statement and proof only slightly to account for punctures in the Conway sphere.

Lemma 3.2 *Let σ be an outermost saddle in F_C . After an isotopy of C that does not change the number of saddles in F_C and leaves both σ and K fixed, B_σ does not contain $+\infty$ or $-\infty$.*

Proof Without loss of generality we will assume D_σ has a unique maximum a (by general position, we can take a to be distinct from any points in $K \cap C$). If B_σ does not contain $+\infty$, then we are done.

Suppose B_σ contains $+\infty$ and α is a monotone arc with endpoints a and $+\infty$ that misses K and intersects C only at local maxima. Label the points of $\alpha \cap C$ in order of increasing height with a, a_1, \dots, a_n . See Figure 2. Again by general position, we can assume all of the a_i 's do not lie on K . Let S_+ be a level sphere contained in a small neighborhood of $+\infty$ such that S_+ does not meet C or K . Let β_n be a subarc of α with endpoints a_n and $+\infty$. Enlarge β_n slightly to be a vertical solid cylinder V such that $\partial(V)$ consists of a small neighborhood of a_n in C , a small disk in S_+ and an annulus A with F_A being a collection of circles. Replacing C with the Conway sphere $(C - V) \cup A \cup (S_+ - V)$ represents an isotopy of C in $S^3 - K$ that does not change the number of saddles in F_C .

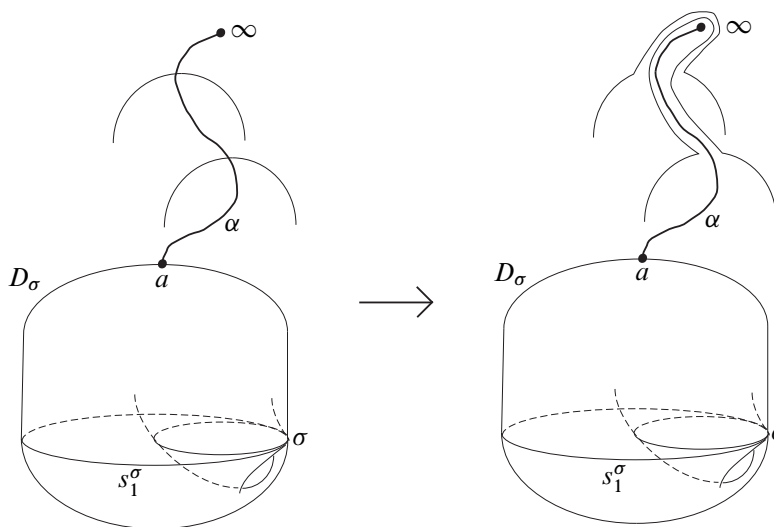

Figure 2

By induction on n , we can assume α is disjoint from C except at the point a . By isotoping D_σ to a new disk D_σ^* in the manner described above, we have enlarged B'_σ to contain $+\infty$ and shrunk B_σ so that it is disjoint from $+\infty$. After a small tilt so that h again restricts to a Morse function on D_σ^* , $F_{D_\sigma^*}$ is a collection of circles and one maximum. The resulting Conway sphere C^* is isotopic to C via an isotopy that leaves σ and K fixed and does not change the number of saddles of F_C . \square

Lemma 3.3 *If F_C contains an inessential saddle, then C is not taut.*

Proof outline (This is Schultens' Lemma 2 in [6].) Suppose F_C contains an inessential saddle σ . Use Lemma 3.2 to ensure B_σ does not contain $+\infty$ or $-\infty$. Isotope $B_\sigma \cap C$

and $B_\sigma \cap K$ out of B_σ in a level preserving way. Now that B_σ is disjoint from C and K , isotope D_σ to D_1^σ via B_σ . After a small tilt, we have eliminated σ without introducing new critical points to $h|_K$ or new saddles to F_C . We conclude C is not taut. \square

Definition 3.4 We say σ is a *removable saddle* if σ is an outermost saddle where D_σ has a unique maximum (minimum) and $h|_{K \cap B_\sigma}$ has a local end-point maximum (minimum) at every point of $K \cap D_\sigma$. See Figure 3. Otherwise, we say σ is nonremovable.

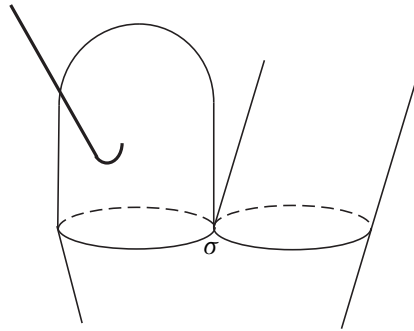

Figure 3

Lemma 3.5 If F_C contains a removable saddle, then C is not taut.

Proof Assume σ is a removable saddle in F_C . Without loss of generality, we can assume D_σ has a unique maximum and $h|_{K \cap B_\sigma}$ has a local maxima at each of $\{k_1, k_2, \dots, k_n\} = D_\sigma \cap K$. By appealing to the isotopy in Lemma 3.2, we can assume that B_σ does not contain $+\infty$. Since D_σ is a monotone disk, $(K \cup C) \cap \text{int}(B_\sigma)$ can be shrunk horizontally and subsequently lowered to lie just below D_1 . This isotopy does not change the number of saddles of F_C nor the number of maxima of $h|_K$, however, it does produce a collection of monotone arcs connecting every k_i to the image of $K \cap \text{int}(B_\sigma)$ under the isotopy. See Figure 4.

The union $D_1 \cup D_\sigma$ now bounds a 3-ball minus a collection of monotone arcs, each of which has one endpoint on D_1 and one endpoint on D_σ . Isotope D_σ to D_1 while fixing K to create C^* . After a small tilt, we have produced a new Conway sphere C^* which is isotopic to C while preserving the number of maxima of $h|_K$. Since the number of saddles of F_{C^*} is one less than the number of saddles of F_C , C is not taut. \square

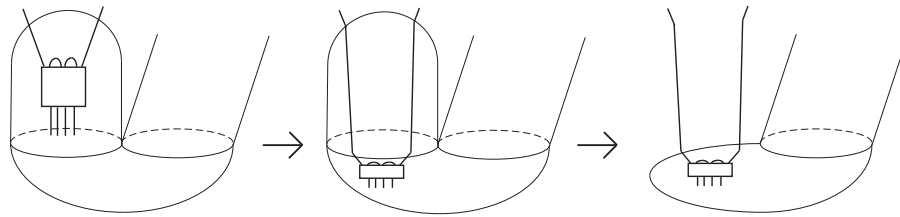

Figure 4

Since $h|_K$ has $\beta(K)$ maxima, we can decompose K into $2\beta(K)$ monotone arcs. Hence, $K = \bigcup_{i=1}^{2\beta(K)} \gamma_i$ where γ_i has one endpoint a maximum and one endpoint a minimum of $h|_K$. If σ is a c -inessential saddle in F_C , then let γ_σ be the γ_i which meets D_σ .

Lemma 3.6 *If F_C contains a nonremovable c -inessential saddle σ such that D_σ has a maximum (minimum) and γ_σ is disjoint from the Conway sphere C above (below) $K \cap D_\sigma$, then C is not taut.*

Proof Without loss of generality we can assume D_σ has a unique maximum and $h|_{K \cap B_\sigma}$ has a local minimum at $p_\sigma = K \cap D_\sigma$. Let $\partial(\gamma_\sigma) = \{x_1, x_2\}$ where x_1 is the highest point on γ_σ and x_2 is the lowest. Let α be the subarc of γ_σ connecting p_σ to x_1 . Since γ_σ is disjoint from C above $K \cap D_\sigma$, we can choose $\mu(\alpha)$ to be a small neighborhood of α such that $\mu(\alpha)$ is disjoint from C except in a small neighborhood of p_σ on C and disjoint from K except for a small neighborhood of α in K . C cuts $\partial(\mu(\alpha))$ into two 1-punctured disks E and F where E is mostly above p_σ and F is mostly below. The 1-punctured disks $\mu(\alpha) \cap C$ and E cobound a 3-ball minus a monotone arc. Hence, there is an isotopy taking $\mu(\alpha) \cap C$ to E that fixes K and results in a new Conway sphere C^* which is isotopic to C but has exactly one new inessential saddle ζ such that s_1^ζ lies in D_σ just above p_σ and s_2^ζ lies in E . ζ is inessential since s_1^ζ bounds an outermost disk D_ζ (the portion of D_σ above p_σ). See Figure 5. It is also important to note that, after this isotopy, $h|_{K \cap B_\sigma}$ now has a local maximum at $K \cap D_\sigma$, though, D_σ is no longer a monotone disk. Using the isotopies in Lemma 3.2 and Lemma 3.3, we can produce another Conway sphere C^{**} by isotoping the disk D_ζ to be level whereby we eliminate ζ without altering the number or nature of maxima of $h|_K$.

Since C^* had one more saddle than C and C^{**} has one less saddle than C^* , then C and C^{**} have the same number of saddles. The aggregate isotopy from C to C^{**} fixes σ , preserves the number of saddles of the Conway sphere, preserves the number

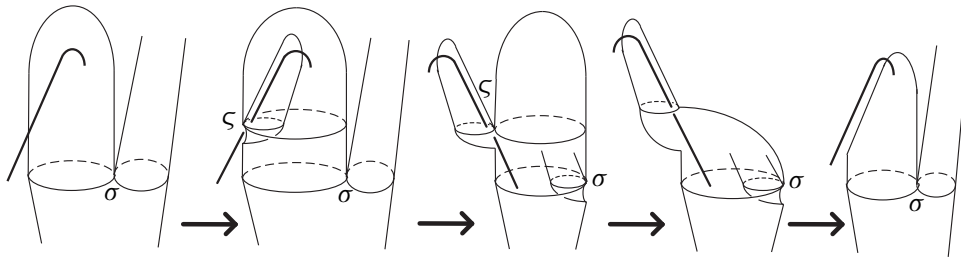

Figure 5

of maxima of $h|_K$, but replaces D_σ with a different outermost disk so that σ is now a removable c -inessential saddle. By Lemma 3.5, C is not taut. \square

The sphere C decomposes S^3 into two 3-balls B_1 and B_2 . Let σ be a saddle in F_C and L be the level sphere either just above or just below σ that contains c_1^σ and c_2^σ . $L - (c_1^\sigma \cup c_2^\sigma)$ is composed of two disks and an annulus A . If a collar of $\partial(A)$ in A is contained in B_1 , then we say σ is *unnested* with respect to B_1 . If not, we say σ is *nested* with respect to B_1 . We define nested and unnested with respect to B_2 similarly. Note that nested with respect to B_1 is the same as unnested with respect to B_2 and nested with respect to B_2 is unnested with respect to B_1 .

Two saddles $\sigma = s_1^\sigma \vee s_2^\sigma$ and $\tau = s_1^\tau \vee s_2^\tau$ in F_C are *adjacent* if, up to labeling, s_1^σ and s_1^τ cobound an annulus in C that is disjoint from s_2^σ, s_2^τ , all other saddles, and K . Recall that, if σ is a standard saddle, E_σ is the monotone disk with boundary σ .

Lemma 3.7 *If σ and τ are adjacent saddles with σ a standard saddle such that $E_\sigma \cap K = \emptyset$ and σ and τ are nested with respect to different 3-balls, then C is not taut.*

Proof This is Schultens' Lemma 3 in [6]. \square

4 Thin position, pods and nesting

In this section, we will exploit a connection between the existence of c -inessential saddles and an isotopy which thins K . Marty Scharlemann coined the term ‘‘Pods’’ for the arrangement of c -inessential saddles that give rise to this isotopy.

Following [3], we make the following definitions.

Definition 4.1 Suppose $K \subset S^3$ is in general position with respect to the standard height function h , $c_0 < c_1 < \dots < c_n$ are the critical values of $h|_K$ and the regular values r_i are chosen so that $c_{i-1} < r_i < c_i$, $i = 1, \dots, n$. The *width of K with respect to h* , denoted by $w(K, h)$, is $\sum_i |h^{-1}(r_i) \cap K|$. The *width of K* , denoted by $w(K)$, is the minimum of $w(K', h)$ over all knots K' isotopic to K . We say that K is in thin position if $w(K, h) = w(K)$.

Recall the definition of bridge position from Section 2. We will be making extensive use of the following fact: If $h|_K$ has $\beta(K)$ maxima and there is a minimum of $h|_K$ above a maximum of $h|_K$, then bridge position for K is not thin position for K .

Definition 4.2 A surface F in $S^3 - K$ is *c-incompressible* if every disk or 1-punctured disk D in $S^3 - K$ with $D \cap F = \partial(D)$ is properly isotopic into F .

In particular, we will be analyzing *c-incompressible Conway spheres*. A Conway sphere C is *c-incompressible* in the complement of a knot K if and only if C is incompressible and neither complementary tangle contains a summand of K . Hence, if K is prime, then every incompressible Conway sphere is *c-incompressible*.

Recall that if σ is a *c-inessential saddle*, then B_σ is the 3-ball with boundary $D_\sigma \cup D_1^\sigma$ and B'_σ is the 3-ball with boundary $D_\sigma \cup (S_\sigma - D_1^\sigma)$ where S_σ is the level surface containing σ . See Figure 1.

Lemma 4.3 *If C is a taut c-incompressible Conway sphere in $S^3 - K$ and σ is a c-inessential saddle in F_C such that D_σ contains a maximum (minimum) of $h|_C$, then each of B_σ and B'_σ contain a maximum (minimum) of $h|_K$.*

Proof Without loss of generality we can assume D_σ contains a maximum. Since C is taut, σ is nonremovable, by Lemma 3.5. Since σ is nonremovable, $h|_{K \cap B_\sigma}$ has a local minimum at $p_\sigma = K \cap D_\sigma$. $h|_K$ is initially increasing as K passes into B_σ and subsequently decreases to exit B_σ through D_1^σ . Hence, $h|_K$ must have a maximum in B_σ .

If $K \cap B'_\sigma$ is not a monotone arc, then there is a maximum of $h|_K$ in B'_σ and we are done.

Suppose $K \cap B'_\sigma$ is a monotone arc with the lower endpoint not in D_2^σ , then $D_2^\sigma \cap K = \emptyset$. $C \cap D_2^\sigma$ is a collection of disjoint simple closed curves. An innermost such curve α bounds a disk E_1 in D_2^σ such that E_1 is disjoint from K and $E_1 \cap C = \partial(E_1)$. By *c-incompressibility* of C , α also bounds a disk E_2 in C that is disjoint from K . Additionally, E_1 and E_2 cobound a 3-ball that is disjoint from K , since K is a

nonsplit link. See Figure 6. Hence, we can eliminate α as a curve of intersection by an isotopy which takes E_2 across this 3–ball and just past E_1 . This isotopy leaves K fixed and can only decrease the number of saddles in F_C . By repeating this process, we can eliminate all curves of intersection of C with $\text{int}(D_2^\sigma)$. Again, by c -incompressibility of C , s_2^σ bounds a disk E_2 in C which is disjoint from K . So, σ is an inessential saddle or an innermost saddle of F_{E_2} is an inessential saddle. By Lemma 3.3, the existence of an inessential saddle implies C is not taut.

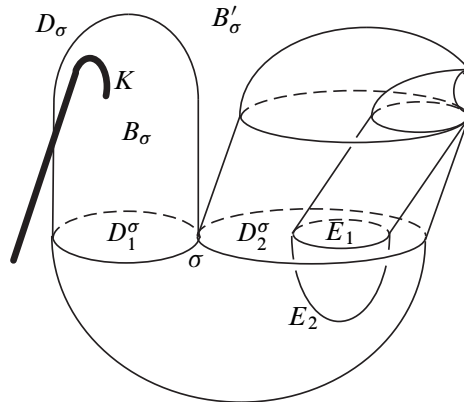

Figure 6

Suppose $K \cap B'_\sigma$ is a monotone arc with the lower endpoint in D_2^σ . Let L be the level surface containing σ . Since $K \cap B'_\sigma$ is a monotone arc, K meets L exactly once outside of D_1^σ . Hence, $K \cap D_2^\sigma$ consists of a single point. $C \cap D_2^\sigma$ is a collection of disjoint simple closed curves. An innermost such curve α bounds a disk E_1 in D_2^σ that is disjoint from C except in its boundary. Since K meets all of D_2^σ in a single point, K meets E_1 in at most one point. See Figure 7. If $E_1 \cap K = \emptyset$, then, as described in the above paragraph, there is an isotopy of C which eliminates α , leaves K fixed, and can only decrease the number of saddles in F_C . If $E_1 \cap K$ is a single point, then, by c -incompressibility of C , α bounds a 1–punctured disk E_2 in C such that $E_1 \cup E_2$ bounds a 3–ball containing a single unknotted subarc of K . Hence, we can eliminate α as an arc of intersection by an isotopy which takes E_2 across this 3–ball and just past E_1 . This isotopy leaves K fixed and can only decrease the number of saddles in F_C . By repeating this process, we can eliminate all arcs of intersection of C with $\text{int}(D_2^\sigma)$. Again, by c -incompressibility of C , s_2^σ bounds a 1–punctured disk E_2 in C such that $D_2^\sigma \cup E_2$ bounds a 3–ball containing a single unknotted subarc of K . We can isotope E_2 to D_2^σ across this 3–ball leaving K fixed. After a small tilt, this isotopy results in a new Conway sphere in general position with respect to h but with

one fewer saddle, having eliminated σ . Since K was fixed at every step of the isotopy, we have shown the original C is not taut with respect to $\beta(K)$. \square

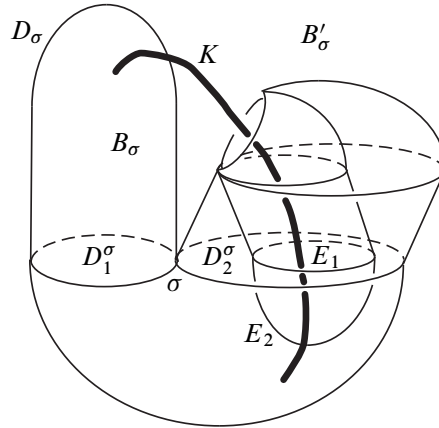

Figure 7

Recall that γ_σ is the monotone subarc of K that meets D_σ for some c-inessential saddle σ in F_C .

Definition 4.4 We say a c-inessential saddle σ in F_C is a *pod* if D_σ contains a maximum (minimum), there is an additional c-inessential saddle ζ such that $D_\zeta \cap K$ is a point on γ_σ above(below) $D_\sigma \cap K$, and D_ζ has a unique minimum(maximum). See Figure 8.

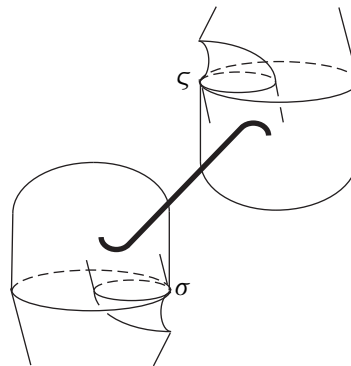

Figure 8

Lemma 4.5 *If C is a taut c -incompressible Conway sphere in $S^3 - K$ and σ is a pod, then bridge position for K is not thin position.*

Proof Without loss of generality, suppose D_σ contains a maximum. Let $\gamma_\sigma \cap D_\sigma = a$ and $\gamma_\sigma \cap D_\zeta = b$, where ζ is a c -inessential saddle, and $h(a) < h(b)$. By Lemma 3.5, we can assume both σ and ζ are nonremovable saddles. Let S be the level surface containing ζ . By the definition of pod, D_ζ has a unique minimum. D_ζ divides the 3-ball below S into two 3-balls B_ζ and B'_ζ . Since ζ is nonremovable, B_ζ contains σ . Since σ and ζ are nonremovable, c -inessential saddles in F_C such that D_σ contains a maximum and D_ζ contains a minimum, then $h_{K \cap B'_\sigma}$ has a local maximum at $K \cap D_\sigma$ and $h_{K \cap B'_\zeta}$ has a local minimum at $K \cap D_\zeta$. We can now appeal to the isotopy in Lemma 3.5 to horizontally shrink and vertically lower B'_σ and horizontally shrink and vertically lift B'_ζ . Since $h(D_\sigma \cap K) < h(D_\zeta \cap K)$, then $h(\sigma) < h(\zeta)$. Hence, we can lower B'_σ and lift B'_ζ until B'_σ lies strictly below B'_ζ . However, by Lemma 4.3, B'_σ contains a maximum of $h|_K$ and B'_ζ contains a minimum of $h|_K$. See Figure 9. Thus, bridge position for K is not thin position for K . \square

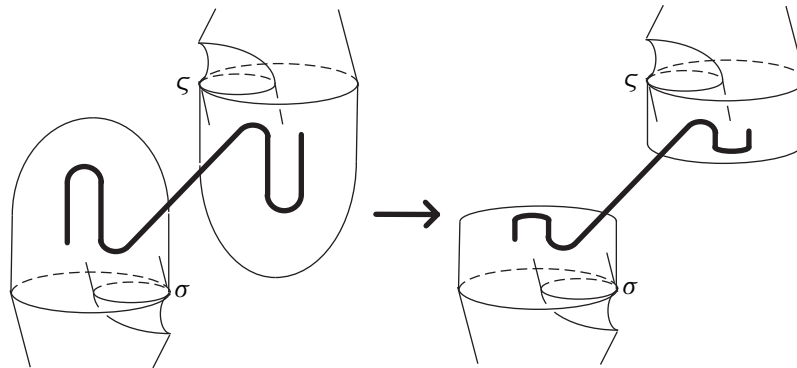

Figure 9

Recall the definitions of standard, outermost, B_σ and A_σ , from Section 2.

Lemma 4.6 *If C is a taut Conway sphere in $S^3 - K$ and σ is an outermost standard saddle in F_C such that $B_\sigma \cap C \neq \emptyset$, then $(B_\sigma \cup A_\sigma)^c$ contains a nonstandard saddle of F_C or a point of $K \cap C$.*

Proof Assume σ is nested with respect to B_1 . Since C is connected and $B_\sigma \cap C \neq \emptyset$, then $(B_\sigma \cup A_\sigma)^c$ contains at least one saddle. Let τ be the saddle in $(B_\sigma \cup A_\sigma)^c$ nearest s_2^σ in C . If τ is nonstandard then we are done. In particular, we can assume

s_2^σ cobounds a monotone annulus A^τ with s_1^τ . If τ is nested with respect to B_2 and $(A^\tau \cup E_\tau) \cap K = \emptyset$, then, by Lemma 3.7, we contradict C being taut. If $(A^\tau \cup E_\tau) \cap K \neq \emptyset$, then we have a point of $K \cap C$ in $(B_\sigma \cup A_\sigma)^c$ and we are done. Hence, we can assume τ is a standard saddle nested with respect to B_1 . s_2^τ can not bound an outermost disk since $B_\sigma \cap C \neq \emptyset$. Let ζ be the saddle nearest to τ in F_C in the direction of c_2^τ . Since τ is nested with respect to B_1 , ζ must be in $(B_\sigma \cup A_\sigma)^c$. If ζ is nonstandard we are done. Hence, we can assume that s_2^τ and s_1^ζ cobound a monotone annulus. We repeat the above argumentation to conclude ζ is nested with respect to B_1 or there is a point of $K \cap C$ in $(B_\sigma \cup A_\sigma)^c$. Inductively, all finitely-many saddles of F_C are standard and nested with respect to B_1 or there is a point of $K \cap C$ in $(B_\sigma \cup A_\sigma)^c$. However, all saddles in F_C being standard and nested with respect to B_1 contradicts $B_\sigma \cap C \neq \emptyset$. Hence, $(B_\sigma \cup A_\sigma)^c$ contains a nonstandard saddle of F_C or a point of $K \cap C$. \square

5 Nonremovable saddles

Lemma 5.1 *The number of outermost disks in F_C is two more than the number of nonstandard saddles in F_C .*

Proof Let \mathcal{A} be the collection of all curves c_σ^i where $i \in \{1, 2, 3\}$ and σ is any saddle in F_C . Viewing C as an embedded surface in S^3 , \mathcal{A} decomposes C into x monotone disks, y pairs of pants and z vertical annuli. See Figure 10. Hence, $\chi(C) = 2 = x - y$. Let x_1 be the number of monotone disks in $C - \mathcal{A}$ with boundary c_σ^1 or c_σ^2 for some saddle σ . Let x_2 be the number of monotone disks in $C - \mathcal{A}$ with boundary c_σ^3 for some saddle σ . By the definition of standard saddle, x_2 is the number of standard saddles in F_C and $y - x_2$ is the number of nonstandard saddles in F_C . By definition of outermost disk, x_1 is the number of outermost disks. Since $2 = x - y$ and $x = x_1 + x_2$, then $x_1 = (y - x_2) + 2$. Hence, The number of outermost disks in F_C is two more than the number of nonstandard saddles in F_C . \square

Remark 1 If there are more than four outermost disks in F_C , then one of these disks does not meet K , so, there is an inessential saddle in F_C . By Lemma 3.3, if C is taut, then F_C contains four or fewer outermost disks and two or fewer nonstandard saddles. Similarly, for every point in $K \cap C$ that is not contained in the collection of outermost disks of F_C there is one fewer outermost disk and one fewer nonstandard saddle possible in F_C .

Definition 5.2 We say a saddle σ in F_C is doubly c-inessential if both s_1^σ and s_2^σ bound outermost disks D_σ and D'_σ in F_C such that each of D_σ and D'_σ meet K in exactly one point.

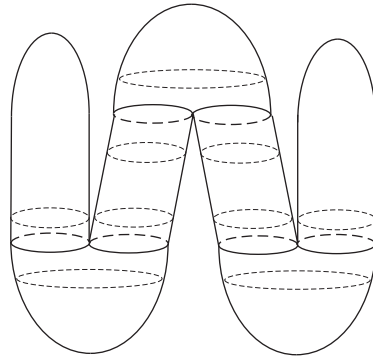

Figure 10

Lemma 5.3 *If C is a taut c -incompressible Conway sphere and bridge position for K is thin position then F_C does not contain any doubly c -inessential saddles.*

Proof Suppose σ is a doubly c -inessential saddle. Assume that both D_σ and D'_σ have maxima (the case where D_σ and D'_σ have minima is proved similarly). Let B_σ be the 3-ball disjoint from s_2^σ with boundary $D_\sigma \cup D_1^\sigma$. Similarly, let B'_σ be the 3-ball disjoint from s_2^σ with boundary $D'_\sigma \cup D_2^\sigma$. If $h|_{K \cap B_\sigma}$ has a maximum at $K \cap D_\sigma$ or $h|_{K \cap B'_\sigma}$ has a maximum at $K \cap D'_\sigma$, then σ is a removable saddle and C is not taut, by Lemma 3.5. Let γ_σ be the monotone strand of K that meets D_σ and γ'_σ be the monotone strand of K that meets D'_σ . If γ_σ is disjoint from C above $K \cap D_\sigma$ or γ'_σ is disjoint from C above $K \cap D'_\sigma$, then F_C is not taut, by Lemma 3.6. Hence, C meets both the interior of B_σ and the interior of B'_σ . Since $C \cap B_\sigma \neq \emptyset$, then σ must be a nonstandard saddle. Let x_1 be the point of $K \cap C$ above $K \cap D_\sigma$ on γ_σ and x_2 be the point of $K \cap C$ above $K \cap D'_\sigma$ on γ'_σ . By Remark 1, σ nonstandard implies at least one of x_1 or x_2 lies on an outermost disk of F_C . x_1 and x_2 cannot lie on a common monotone disk of F_C since such a disk cannot meet both the interior of B_σ and the interior of B'_σ . Figure 11 illustrates one potential embedding of C .

Without loss of generality, suppose x_1 lies on an outermost disk D_ζ of F_C . x_1 must be the unique point of $C \cap K$ that meets D_ζ , so ζ is a c -inessential saddle.

If ζ is a removable c -inessential saddle, then, by Lemma 3.5, C is not taut.

If ζ is a nonremovable c -inessential saddle such that D_ζ has a minimum, then ζ and σ are pods. By Lemma 4.5, C is not taut or bridge position for K is not thin position.

If ζ is a nonremovable c -inessential saddle such that D_ζ has a maximum, then γ_ζ is disjoint from C above x_1 and, by Lemma 3.6, C is not taut. \square

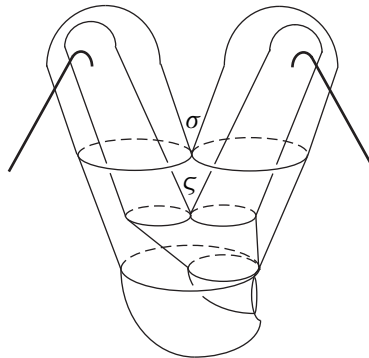

Figure 11

Corollary 5.4 *If C is a taut c -incompressible Conway sphere in $S^3 - K$ and bridge position for K is thin position, then there is a one-to-one correspondence between nonremovable c -inessential saddles of F_C and outermost disks of F_C that meet K in exactly one point.*

Proof There is an obvious well-defined map between 1-punctured outermost disks and c -inessential saddles. This map sends each outermost disk to the saddle that contains its boundary. If two or more disks get mapped to the same saddle then this saddle is doubly c -inessential. However, this contradicts Lemma 5.3. Thus, there is a one-to-one correspondence between nonremovable c -inessential saddles of F_C and outermost disks of F_C that meet K in exactly one point. \square

Lemma 5.5 *Let C be a c -incompressible Conway sphere in $S^3 - K$. If F_C contains distinct c -inessential saddles σ and ζ such that D_σ has a maximum (minimum) and D_ζ meets γ_σ above(below) $D_\sigma \cap K$, then C is not taut or bridge position for K is not thin position.*

Proof Both σ and ζ are nonremovable or else C is not taut, by Lemma 3.5. Without loss of generality, suppose D_σ contains a maximum and $D_\zeta \cap K = b$ is above $D_\sigma \cap K = a$ on γ_σ . If D_ζ has a minimum, then σ is a pod and C is not taut or bridge position for K is not thin position, by Lemma 4.5. Hence, we can assume that D_ζ has a maximum.

Suppose C meets γ_σ exactly once above a . Then C is disjoint from γ_σ above b . By Lemma 3.6, C is not taut.

Suppose C meets γ_σ exactly twice above a in the points b and c . If b is the highest of these two points, then, by Lemma 3.6, C is not taut. If c is the highest of these two

points, poke a small neighborhood of the point c in C along γ_σ toward and slightly past the maximum of γ_σ as in the proof of Lemma 3.6. This isotopy fixes K , but adds a single c -inessential saddle to F_C . After this isotopy, $\{a, b\} = \gamma_\sigma \cap C$. Hence, we can perform the isotopy in Lemma 3.6 to eliminate first ζ and subsequently σ . See Figure 12. The net effect of this isotopy is to decrease the number of saddles in F_C by one while preserving the number of maxima of $h|_K$. This contradicts the assumption that C is taut.

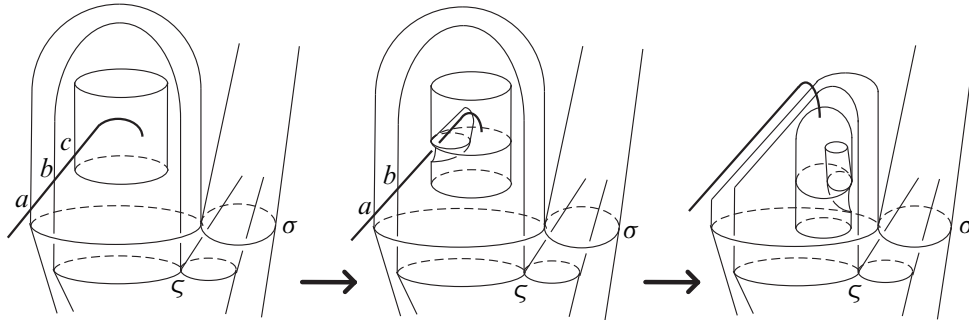

Figure 12

Suppose C meets γ_σ exactly three times above $D_\sigma \cap K$ in points b , c and d . In this case all points of $K \cap C$ are contained in B_σ . By Lemma 4.6, either σ is nonstandard or there exists a nonstandard saddle of F_C in $(B_\sigma \cup A_\sigma)^c$. Then, by Remark 1, there are at least three outermost disks D_σ , D_ζ , and D_τ in F_C . Again by Remark 1, at least one of D_ζ and D_τ meet K in a single point. We now analyze the possibilities for D_τ .

Assume D_τ meets K exactly once at the point c . τ is a nonremovable c -inessential saddle or else C is not taut, by Lemma 3.5. If D_τ has a minimum, then τ and σ are pods and, by Lemma 4.5, C is not taut or bridge position for K is not thin position. So, we can assume D_τ has a maximum. Recall from the first paragraph of this proof that we have assumed D_ζ has a maximum.

If b or c is the highest of the four points on γ_σ , we can use the isotopy from Lemma 3.6 to eliminate ζ or τ contradicting the fact that C is taut. Hence, we can assume d is that highest of the four points. Poke a small neighborhood of the point d in C in along γ_σ toward and slightly past the maximum of γ_σ . This isotopy fixes K , but adds a single c -inessential saddle to F_C . After this isotopy, $\{a, b, c\} = \gamma_\sigma \cap C$. Hence, we can perform the isotopy in Lemma 3.6 to eliminate first τ , then ζ and finally σ . This isotopy is similar to that of Figure 12, but with three nonremovable, c -inessential saddles. The net effect of this isotopy is to decrease the number of saddles in F_C by

two while preserving the number of maxima of $h|_K$. Hence, we conclude C is not taut.

Assume D_τ meets K exactly twice. Label the points of $\gamma_\sigma \cap C$ from lowest to highest as $\{a, b, c, d\}$ where $a = K \cap D_\sigma$. If $d = K \cap D_\zeta$, then we can eliminate ζ as in Lemma 3.6 and conclude F_C is not taut. By parity, the labels of the two points in $K \cap D_\tau$ must be consecutive. Hence, $b = K \cap D_\zeta$ and $\{c, d\} = K \cap D_\tau$.

Suppose D_τ contains a maximum. Poke a small neighborhood of d in D_τ along γ_σ toward and just past the maximum of γ_σ . Since γ_σ is disjoint from C above d , this isotopy creates a single new inessential saddle. Eliminate this saddle using the isotopy in Lemma 3.3. After these isotopies, $\{a, b, c\} = C \cap \gamma_\sigma$. Poke a small neighborhood of the point c in C in along γ_σ toward and slightly past the maximum of γ_σ . This isotopy fixes K but adds a single c -inessential saddle to F_C as in Figure 13. After this isotopy, $\{a, b\} = \gamma_\sigma \cap C$.

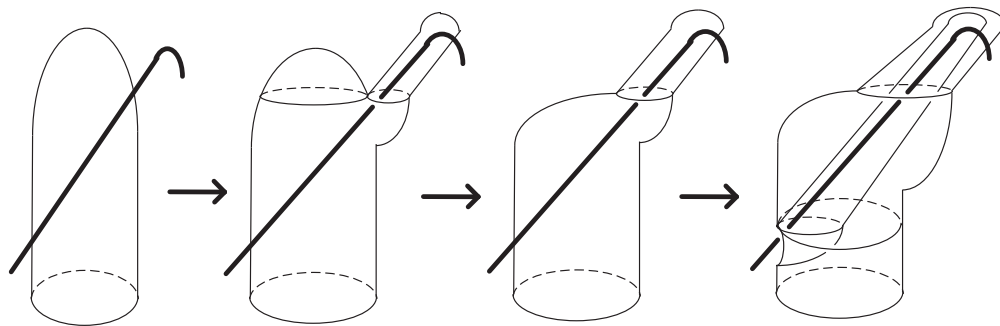

Figure 13

Hence, we can perform the isotopy in Lemma 3.6 to eliminate first ζ and then σ . The net effect of this isotopy is to decrease the number of saddles in F_C by one while preserving the number of maxima of $h|_K$. Hence, C is not taut.

Suppose D_τ contains a minimum. Let S_τ be the level surface containing τ . D_τ divides the 3-ball below S_τ into two three balls B_τ and B'_τ where we choose the labels in the unconventional way where B_τ contains σ and may or may not contain s_2^τ in its boundary.

Let F be a level disk properly embedded in B'_τ that lies below τ but above d .

Claim *There is a minimum of $h|_K$ contained in B'_τ below F .*

Proof We know by hypothesis that there is a monotone subarc of K in B'_τ connecting c to d . Suppose, to form a contradiction, that $F \cap K = \emptyset$. $C \cap F$ is a collection of disjoint simple close curves. An innermost such curve α bounds a disk E_1 in F with interior disjoint from both C and K . By c -incompressibility of C , α also bounds a disk E_2 in C that is disjoint from K . Additionally, E_1 and E_2 cobound a 3-ball which is disjoint from K , since K is not split. Hence, we can eliminate α as an arc of intersection by an isotopy which takes E_2 across this 3-ball and just past E_1 . This isotopy leaves K fixed and can only decrease the number of saddles in F_C . By repeating this process, we can eliminate all curves of intersection of C with $\text{int}(F)$. If C and K are disjoint from $\text{int}(F)$, then F is an essential compressing disk for C and we contradict c -incompressibility of C . We conclude that $K \cap F \neq \emptyset$. However, any arc of K with endpoints in F must have a minimum in B'_τ below F . This proves the claim. \square

By appealing to Lemma 3.2, we can assume B'_σ does not contain $+\infty$ and B'_τ does not contain $-\infty$. Horizontally shrink and vertically lift the portion of B'_τ below c until the minimum of D_τ is just below c . Horizontally shrink and vertically lower B'_σ until the maximum of D_σ is just above a . Since $h(c) > h(a)$, this isotopy insures that B'_τ lies completely above B'_σ . By Lemma 4.3, there is a maximum of $h|_K$ in B'_σ and, by the above claim, there is a minimum of $h|_K$ in B'_τ . Bridge position for K is not thin position for K since we have isotoped a minimum of $h|_K$ above a maximum of $h|_K$ without introducing any new critical points. See Figure 14. \square

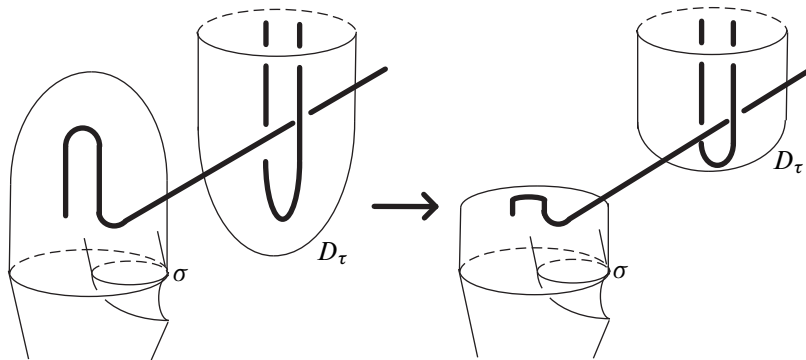

Figure 14

Theorem 5.6 *Let C be a c -incompressible Conway sphere in $S^3 - K$. If F_C contains both a c -inessential saddle σ and a nonstandard saddle, then C is not taut or bridge position for K is not thin position.*

Proof If σ is removable then C is not taut, by Lemma 3.5. Hence we can assume σ is nonremovable and D_σ has a unique maximum. By Remark 1, F_C contains at least three outermost disks with each disk meeting K at least once or C is not taut. Hence, we will assume F_C contains a second c-inessential saddle τ . We will break the proof up into cases based on $|C \cap \gamma_\sigma|$.

Suppose $|C \cap \gamma_\sigma| = 1$. By Lemma 3.6, C is not taut.

Suppose $|C \cap \gamma_\sigma| = 2$. Let $\{a, b\} = C \cap \gamma_\sigma$ where $a = D_\sigma \cap K$. By Lemma 3.6, $h(b) < h(a)$ implies C is not taut. Assume $h(b) > h(a)$ and we proceed by cases.

Case I Suppose $b \in D_\zeta$ for some c-inessential saddle ζ in F_C . By Lemma 5.5, C is not taut or bridge position for K is not thin position.

Case II Suppose b is not the puncture associated to a c-inessential saddle of F_C .

Case II.A Additionally, suppose that b is not contained in an outermost disk in F_C . Since b is not contained in an outermost disk and C is taut, then each of the three outermost disks of F_C meets K exactly once. By Corollary 5.4, F_C contains three distinct c-inessential saddles, σ , ζ and τ . By Lemma 3.5, we can assume both ζ and τ are nonremovable. Assume that D_ζ has a unique maximum. By Lemma 3.6, C meets γ_ζ above $D_\zeta \cap K$ or C is not taut. Since $|C \cap \gamma_\sigma| = 2$ and $b \neq D_\zeta \cap K$, then γ_ζ is distinct from γ_σ and $D_\tau \cap K$ is the unique point of intersection of C with γ_ζ above $D_\zeta \cap K$. By Lemma 5.5, C is not taut or bridge position for K is not thin position. The proof when D_ζ has a unique minimum follows similarly.

Case II.B Suppose b is contained in an outermost disk D_ζ where $\partial(D_\zeta) = s_1^\zeta$ for some saddle $\zeta = s_1^\zeta \vee s_2^\zeta$ in F_C . Since we have assumed b is not the puncture associated to a c-inessential saddle of F_C , then D_ζ must have one or two additional punctures. Since each of the three outermost disks must meet K at least once, D_ζ meets K exactly twice. Let $D_\zeta \cap K = \{b, b'\}$.

The other c-inessential saddle τ , like σ , must be nonremovable and $|\gamma_\tau \cap C| \geq 2$ or else we can use Lemma 3.5 or Lemma 3.6 to show C is not taut. By assumption, $|C \cap \gamma_\sigma| = 2$ and, thus, γ_σ is distinct from γ_τ .

Hence, $C \cap \gamma_\tau = \{c, b'\}$ where $c = D_\tau \cap K$. We have now accounted for all four points of $K \cap C$ (c and b' on γ_τ , and a and b on γ_σ). We focus on the monotone strand of K that meets D_ζ nearest its maxima (minima). If this strand is γ_σ , then our labeling stays the same and we move on. If this strand is γ_τ , then we swap the labels b and b' as well as τ and σ . Additionally, we reflect along a level sphere if necessary so that D_σ continues to have a unique maximum. Figure 15 illustrates one possible configuration of σ , τ and ζ .

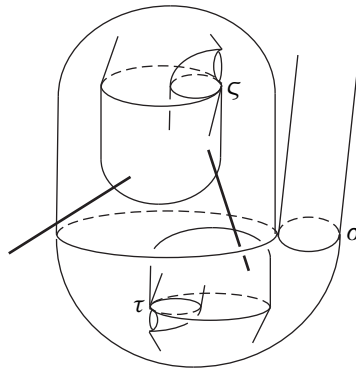

Figure 15

Case II.B.i Suppose D_ζ has a maximum. Poke a neighborhood of b in D_ζ along γ_σ away from a and just past the maxima of γ_σ as in the proof of Lemma 3.6. Since we have renamed so that b is higher on D_ζ than b' and γ_σ is disjoint from C above b , then this isotopy of D_ζ creates a single inessential saddle. Use the isotopy in Lemma 3.3 to eliminate the resulting inessential saddle. The net result of these isotopies is to leave the number of saddles in F_C and the number of maxima of $h|_K$ unchanged. Additionally, this isotopy results in a being the only point of intersection of C with γ_σ . By Lemma 3.6, C is not taut.

Case II.B.ii Suppose D_ζ has a minimum. Let S_ζ be the level surface containing ζ . D_ζ divides the 3-ball below S_ζ into two 3-balls B_ζ and B'_ζ where we choose the labels in the unconventional way where B_ζ contains σ and may or may not contain s_2^ζ in its boundary.

Case II.B.ii.a If $h|_{K \cap B'_\zeta}$ has a maximum at b' , then there must be a minimum of $h|_K$ in B'_ζ or $\gamma_\sigma = \gamma_\zeta$. However, the second possibility would imply $|\gamma_\sigma \cap C| > 2$. So, we can assume there is a minimum of $h|_K$ in B'_ζ . By Lemma 3.2, we can assume B'_ζ does not contain $-\infty$ and B'_σ does not contain $+\infty$. As in Lemma 4.5, we can horizontally shrink and vertically lift the portion of B'_ζ lying below b' so that the resulting minimum of D_ζ lies just below b' and horizontally shrink and vertically lower B'_σ so that it lies just above σ . By Lemma 4.3, B'_σ contains a maximum of $h|_K$ and, by the argument above, B'_ζ contains a minimum of $h|_K$. Since we have isotoped a minimum of $h|_K$ above a maximum of $h|_K$, bridge position for K is not thin position.

Case II.B.ii.b Suppose $h|_{K \cap B'_\zeta}$ has a minimum at b' .

Suppose c is above b' on γ_τ . Since we have assumed $h(b) < h(b')$, then $h(a) < h(b) < h(b') < h(c)$. Since c is the highest point of $C \cap K$, then, if D_τ has a maximum, C is

not taut, by Lemma 3.6. If D_τ has a minimum, then $h(a) < h(c)$ implies $h(\sigma) < h(\zeta)$ and we can appeal to the proof of Lemma 4.5 to show bridge position for K is not thin position. Hence, we can assume $h(c) < h(b')$.

If $\zeta \subset \partial(B_\zeta)$, then ζ is a removable saddle and C is not taut, by Lemma 3.5. So, we can assume $\zeta \subset \partial(B'_\zeta)$. Since D_ζ contains two punctures, there can be at most three outermost disks in F_C and, thus, at most one nonstandard saddle. With that in mind, at least one of σ and τ is standard. Both σ and τ are nonremovable, c-inessential saddles. We will assume σ is standard (the case when τ is standard is proved analogously). This is the configuration depicted in Figure 15. Additionally, we can see $(B_\sigma \cup A_\sigma)^c$ is disjoint from $C \cap K$.

Since $B_\sigma \cup A_\sigma$ contains all of $C \cap K$, then, by Lemma 4.6, $(B_\sigma \cup A_\sigma)^c$ contains the unique nonstandard saddle for F_C . Since $\zeta \subset \partial(B'_\zeta)$, the potentially nonstandard labeling of B_ζ and B'_ζ we have assumed for this case matches the standard labeling as outlined in Section 2. With that in mind, $\sigma \in B_\zeta$ and ζ standard imply that $(B_\sigma \cup A_\sigma)^c$ and $(B_\zeta \cup A_\zeta)^c$ are disjoint. Since $(B_\sigma \cup A_\sigma)^c$ contains the unique nonstandard saddle for F_C , then $(B_\zeta \cup A_\zeta)^c$ does not contain a nonstandard saddle. Since B_ζ meets C , $(B_\zeta \cup A_\zeta)^c$ is disjoint from $C \cap K$, and $(B_\zeta \cup A_\zeta)^c$ does not contain a nonstandard saddle, then C is not taut, by Lemma 4.6.

Suppose $|C \cap \gamma_\sigma| = 3$. Let σ and τ be c-inessential saddles where $D_\sigma \cap K = a$ and $D_\tau \cap K = b$. By Lemma 3.5 and Lemma 3.6, both σ and τ are nonremovable saddles and both $|\gamma_\sigma \cap C|$ and $|\gamma_\tau \cap C|$ are greater than one or else C is not taut. If b is not contained in γ_σ , then $|\gamma_\tau \cap C| = 1$ and C is not taut, by Lemma 3.6. So, we can assume $\gamma_\sigma = \gamma_\tau$. If D_τ has a minimum and $h(a) < h(b)$, then τ and σ are pods. Hence, C is not taut or bridge position for K is not thin position for K , by Lemma 4.5. If D_τ has a minimum and $h(a) > h(b)$, then γ_σ is disjoint from C either above a or below b . In either case, we can use the isotopy in Lemma 3.6 to eliminate one of σ and τ and conclude C is not taut. Hence, we can assume D_τ has a maximum and b is contained in γ_σ . Since both D_σ and D_τ contain maxima, then, up to relabeling of σ and τ , we can assume $h(b) > h(a)$. By Lemma 5.5, C is not taut or bridge position for K is not thin position.

Suppose $|C \cap \gamma_\sigma| = 4$. Without loss of generality, we will assume that D_σ has a maximum. Label the points of $C \cap \gamma_\sigma = \{a, b, c, d\}$ in order of increasing height so that $h(a) < h(b) < h(c) < h(d)$.

If there are three or more c-inessential saddles in F_C , any possible arrangement satisfies the hypothesis of Lemma 5.5, showing C is not taut or thin position for K is not bridge position. Hence, we can assume there are at most two c-inessential saddles in F_C .

Let $p_\sigma = D_\sigma \cap K$ and $p_\tau = D_\tau \cap K$. Since there are at most two c -inessential saddles and at least one nonstandard saddle in F_C , the points in $C \cap K$ which are not p_σ and p_τ are the punctures of a 2-punctured outermost disk in F_C . By parity, these two punctures must be consecutive. Recall we have assumed D_σ contains a maximum.

If $p_\sigma = d$ then, by Lemma 3.6, C is not taut with respect to $\beta(K)$.

If $p_\sigma = c$, then a and b are the punctures on the twice punctured outermost disk and $p_\tau = d$. Since p_τ is above p_σ on γ_σ , C is not taut or bridge position for K is not thin position, by Lemma 5.5.

If $p_\sigma = b$, then c and d are the punctures on the twice punctured outermost disk and $p_\tau = a$. Since C is disjoint from γ_σ below a , then, by Lemma 3.6, D_τ has a maximum or C is not taut or bridge position for K is not thin position. However, if D_τ has a maximum, then p_σ is above p_τ on γ_σ and C is not taut or bridge position for K is not thin position for K , by Lemma 5.5.

If $p_\sigma = a$, then p_τ is above p_σ on γ_σ and, by Lemma 5.5, C is not taut or bridge position for K is not thin position. \square

Theorem 5.7 *Let C be a c -incompressible Conway sphere in $S^3 - K$. If F_C contains a c -inessential saddle σ and contains only standard saddles, then C is not taut or bridge position for K is not thin position.*

Proof If σ is removable then C is not taut, by Lemma 3.5. Hence, we can assume σ is nonremovable. Without loss of generality, we will assume D_σ contains a maximum. By Lemma 5.1, F_C contains only standard saddles implies C is not taut or F_C contains exactly two outermost disks D_σ and D_ζ . Hence, we will assume F_C contains exactly two outermost disks D_σ and D_ζ . If $\sigma = \zeta$, then there is a unique saddle in F_σ . Since C is disjoint from the interior of B_σ , γ_σ is disjoint from C above $D_\sigma \cap K$. Thus, C is not taut, by Lemma 3.6. Henceforth, we will assume that σ is distinct from ζ . Let $a = D_\sigma \cap K$. We will proceed by cases.

Case I Suppose C is disjoint from γ_σ above a . By Lemma 3.6, C is not taut.

Case II Suppose C meets γ_σ above a in exactly one point b .

Case II.A If b is not contained in D_ζ , then poke a neighborhood of b in C along γ_σ toward and just past the maximum of γ_σ as in the proof of Lemma 3.6. Since γ_σ is disjoint from C above b , this isotopy leaves K fixed while adding exactly one c -inessential saddle τ to F_C . If b was not originally contained on a monotone disk of F_C , then τ is nonstandard. If b was originally contained on a monotone disk of F_C such that this disk has a unique maximum, then τ is nonstandard. If b was originally

contained on a monotone disk D of F_C such that this disk has a unique minimum, then $\partial(D) = \delta$ where δ is a saddle in F_C . In this case, δ is nonstandard after the isotopy. Hence, we can assume that, after the isotopy, F_C contains a nonstandard saddle. Additionally, after this isotopy, γ_σ is disjoint from C above a . Hence, we can use the isotopy in the proof of Lemma 3.6 to eliminate σ . The net change to the number of saddles in F_C under these two isotopies is zero. However, F_C now contains both a c-inessential saddle and a nonstandard saddle. Thus, C is not taut or bridge position for K is not thin position, by Theorem 5.6. See Figure 16.

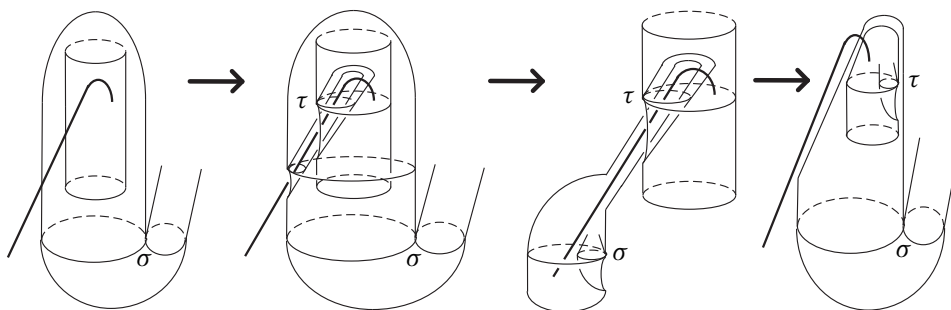

Figure 16

Case II.B.i If b is contained in D_ζ and $K \cap D_\zeta = \{b\}$, then C is not taut or bridge position for K is not thin position for K , by Lemma 5.5.

Case II.B.ii b is contained in D_ζ and $K \cap D_\zeta = \{b, b'\}$.

Case II.B.ii.a Suppose D_ζ has a maximum and $h(b) > h(b')$. Poke a neighborhood of b in C along γ_σ toward and just past the maximum of γ_σ as in Lemma 3.6. Since γ_σ is disjoint from C above b , this isotopy leaves K fixed while adding exactly one saddle τ to F_C . Since D_ζ is disjoint from K above b , τ is an inessential saddle. We can eliminate τ using the isotopy from Lemma 3.3. After these two isotopies, the number of saddles in F_C has not been changed and γ_σ is disjoint from C above a . By Lemma 3.6, C is not taut.

Case II.B.ii.b Suppose D_ζ has a maximum and $h(b') > h(b)$. Poke a neighborhood of b in C along γ_σ toward and just past the maximum of γ_σ as in Lemma 3.6. Since γ_σ is disjoint from C above b , this isotopy leaves K fixed while adding exactly one saddle τ to F_C . Since D_ζ meets K only in b' above b , then τ is a doubly c-inessential saddle. After this isotopy, γ_σ is disjoint from C above a . Hence, we can eliminate σ by using the isotopy from Lemma 3.6. The net effect of these isotopies is to leave the number of saddles in F_C unchanged and introduce a doubly c-inessential saddle τ . By Lemma 5.3, C is not taut or bridge position for K is not thin position for K .

Case II.B.ii.c Suppose D_ζ has a minimum. Let $\zeta = s_1^\zeta \vee s_2^\zeta$. Since D_ζ is an outermost disk, then, up to relabeling, we can assume that $\partial(D_\zeta) = s_1^\zeta$. Let S_ζ be the level surface containing ζ . D_ζ cuts the three ball below S_ζ in to two 3-balls B_ζ and B'_ζ as described in Section 2. By hypothesis, ζ is a standard saddle and, thus, is the boundary of a monotone disk E_ζ . Since C is embedded, E_ζ is contained completely in B_σ . If $E_\zeta \cap K \neq \emptyset$, then all four points of $C \cap K$ are contained in $B_\sigma \cup A_\sigma$ and K is disjoint from E_σ . By Lemma 4.6, C is not taut or bridge position for K is not thin position for K . Hence we can assume that $E_\zeta \cap K = \emptyset$. Since all saddles in F_C are standard, then, by Lemma 4.6, we can assume $(B_\zeta \cup A_\zeta)^c$ contains at least one point of $C \cap K$. If σ is contained in B_ζ , then $(B_\zeta \cup A_\zeta)^c$ is contained in $\text{int}(A_\sigma \cup B_\sigma)$ and $A_\sigma \cup B_\sigma$ contains all four points of $C \cap K$. Then, by Lemma 4.6, C is not taut or bridge position for K is not thin position. Hence, we can assume that σ is contained in B'_ζ . Since σ is contained in B'_ζ , then $h_{K \cap B_\zeta}$ has a minimum at b . If b' is a minimum of $h_{K \cap B'_\zeta}$, then ζ is a removable saddle and C is not taut, by Lemma 3.5. Hence, we can assume that b' is a maximum of $h_{K \cap B'_\zeta}$. This leads us to the following two possibilities. After these observations, one possible arrangement of K , σ and ζ is depicted in Figure 17.

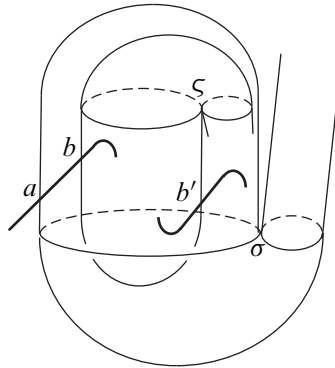

Figure 17

Case II.B.ii.c.1 D_ζ has a minimum, B'_ζ contains σ , b' is a maximum of $h_{K \cap B'_\zeta}$ and $h(b) < h(b')$. Since b' is a maximum of $h|_{K \cap B'_\zeta}$ and b' is not on γ_σ , then there is a minimum of $h|_K$ in B_ζ .

By appealing to Lemma 3.2, we can assume B'_σ does not contain $+\infty$ and B_ζ does not contain $-\infty$. Since σ is a nonremovable, c-inessential saddle in F_C such that D_σ contains a maximum, then $h_{K \cap B'_\sigma}$ has a local maximum at $K \cap D_\sigma$. Since $h|_{K \cap B'_\sigma}$ has a local maximum at a , we can appeal to the isotopy in Lemma 3.5 to horizontally shrink and vertically lower B'_σ until $h(B'_\sigma)$ lies between $h(\sigma)$ and $h(\sigma) + \varepsilon$ for any

$\varepsilon > 0$. Since b is the lowest point of intersection of K with D_ζ we can horizontally shrink and vertically raise the portion of B_ζ that lies below b until $h(B_\zeta)$ is contained between $h(b) - \varepsilon$ and $h(\zeta)$ for any $\varepsilon > 0$. Since $h(b) > h(a)$, then $h(b) > h(\sigma)$. Hence, we can lower B'_σ and raise B_ζ until B'_σ lies strictly below B_ζ without changing the number of maxima of $h|_K$ and without introducing any new saddles. However, by Lemma 4.3, B'_σ contains a maximum of $h|_K$ and, by the above argument, B_ζ contains a minimum of $h|_K$. Thus, bridge position for K is not thin position.

Case II.B.ii.c.2 D_ζ has a minimum, B'_ζ contains σ , b' is a maximum of $h|_{K \cap B_\zeta}$ and $h(b') < h(b)$. This is the situation depicted in Figure 17. Let $\gamma_{b'}$ be the maximal monotone subarc of K that contains b' . If $\gamma_{b'}$ meets C at any point other than b' then $B_\sigma \cup A_\sigma$ contains all four points of $C \cap K$ and, by Lemma 4.6, C is not taut or bridge position of K is not thin position. Hence, we can assume that $\gamma_{b'} \cap C = \{b'\}$.

Poke a neighborhood of b' in C along $\gamma_{b'}$ toward and just past the minimum of $\gamma_{b'}$ as in Lemma 3.6. Since $\gamma_{b'}$ is disjoint from C below b' , this isotopy leaves K fixed while adding exactly one saddle τ to F_C . Since D_ζ is disjoint from K below b' , then τ is an inessential saddle. We can eliminate τ using the isotopy from Lemma 3.3. After these two isotopies, the number of saddles in F_C has not been changed and both points of intersection of K with D_ζ are minima of $h|_{K \cap B_\zeta}$. Hence, ζ is a removable saddle and C is not taut, by Lemma 3.5. See Figure 18.

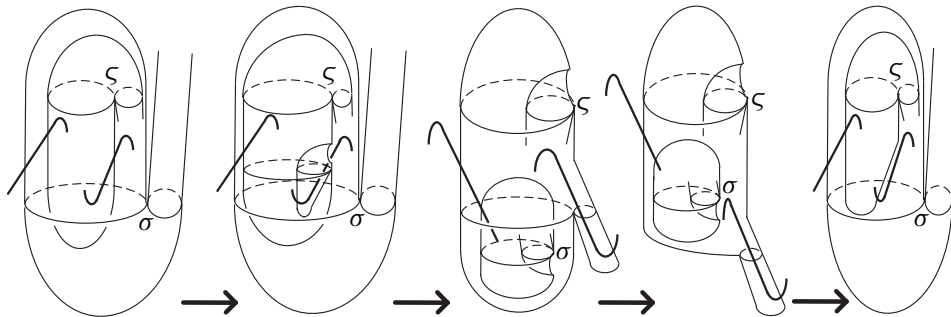

Figure 18

Case II.B.iii Assume b is contained in D_ζ and $K \cap D_\zeta = \{b, b', b''\}$. In this case, all four points of $C \cap K$ are contained in $B_\sigma \cup A_\sigma$ and σ is a standard saddle such that K is disjoint from E_σ . Since $(B_\sigma \cup A_\sigma)^c$ contains only standard saddles and is disjoint from $K \cap C$, then C is not taut, by Lemma 4.6.

Case III Suppose C meets γ_σ above a in exactly two points b and c where $h(a) < h(b) < h(c)$.

If both b and c are disjoint from D_ζ , then ζ is a nonremovable c -inessential saddle or else C is not taut. If γ_ζ is distinct from γ_σ , then γ_ζ consists of a single point and C is not taut, by Lemma 3.6. If $\gamma_\zeta = \gamma_\sigma$, then $D_\zeta \cap K$ is below a on γ_σ . If D_ζ has a maximum, then C is not taut or bridge position for K is not thin position, by Lemma 5.5. If D_ζ has a minimum, then C is not taut, by Lemma 3.6. Hence, we can assume that b or c lie on D_ζ .

If D_ζ meets K in a single point, then that point is either b or c and ζ is a c -inessential saddle. By Lemma 5.5, C is not taut or bridge position for K is not thin position. If D_ζ meets K in two points, one of which is not contained in the set $\{b, c\}$, then $B_\sigma \cup A_\sigma$ contains all four points of $C \cap K$ and, by Lemma 4.6, C is not taut or bridge position for K is not thin position. If D_ζ meets K in three points, then $B_\sigma \cup A_\sigma$ contains all four points of $C \cap K$ and, by Lemma 4.6, C is not taut or bridge position for K is not thin position. Hence, we can assume D_ζ meets K in exactly the two points b and c .

Case III.A Suppose D_ζ has a maximum and D_ζ meets K in exactly the two points b and c . Poke a neighborhood of c in C along γ_σ toward and just past the maximum of γ_σ as in Lemma 3.6. Since γ_σ is disjoint from C above c , this isotopy leaves K fixed while adding exactly one saddle τ to F_C . Since D_ζ is disjoint from K above c , then τ is an inessential saddle. We can eliminate τ using the isotopy from Lemma 3.3. This is illustrated in Figure 19. After these two isotopies, neither the number of critical points of $h|_K$ nor the number of saddles in F_C has been changed and C meets γ_σ above a in exactly one point. Hence, we have reduced this case to Case II and can conclude C is not taut or bridge position for K is not thin position.

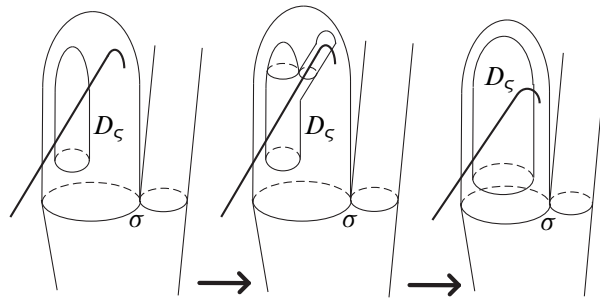

Figure 19

Case III.B Suppose D_ζ has a minimum and D_ζ meets K in exactly the two points b and c . Let S_c be a level surface just above c . The portion of D_ζ that lies below S_c cuts the 3-ball below S_c into two 3-balls B_c and B'_c where we choose the labeling

such that B'_c contains σ . The curve $D_c \cap S_c$ cuts S_c into two disks D_c and D'_c where D_c meets B_c . If D_c is disjoint from K , then we can use an innermost disk argument and the fact that C is incompressible to isotope C to be disjoint from D_c while leaving K fixed and possibly decreasing the number for saddles of F_C . After this isotopy, D_c is a compressing disk for C , contradicting the fact that C is incompressible. Hence, we can assume that K is not disjoint from D_c . Since K is not disjoint from D_c and b is connected to c in B_c via a monotone subarc of K , then there must be a minimum of $h|_K$ in B_c . By appealing to Lemma 3.2, we can assume B'_σ does not contain $+\infty$ and B_c does not contain $-\infty$. Since σ is a nonremovable, c -inessential saddle in F_C such that D_σ contains a maximum, then $h_{K \cap B'_\sigma}$ has a local maximum at $K \cap D_\sigma$. Since $h|_{K \cap B'_\sigma}$ has a local maximum at a , we can appeal to the isotopy in Lemma 3.5 to horizontally shrink and vertically lower B'_σ until $h(B'_\sigma)$ lies between $h(\sigma)$ and $h(\sigma) + \varepsilon$ for any $\varepsilon > 0$. Since D_c is disjoint from K below b , we can horizontally shrink and vertically raise the portion of B_c that lies below b until $h(B_c)$ is contained between $h(b) - \varepsilon$ and $h(S_c)$ for any $\varepsilon > 0$. Since $h(b) > h(a)$, then $h(b) > h(\sigma)$. Hence, we can lower B'_σ and raise B_c until B'_σ lies strictly below B_c without changing the number of maxima of h_K and without introducing any new saddles. However, by Lemma 4.3, C is not taut or B'_σ contains a maximum of $h|_K$ and, by the above argument, B_c contains a minimum of $h|_K$. Thus, C is not taut or bridge position for K is not thin position for K .

Case IV Suppose C meets γ_σ above a in exactly three points. In this case, all four points of $C \cap K$ are contained in $B_\sigma \cup A_\sigma$ and σ is a standard saddle such that K is disjoint from E_σ . Since $(B_\sigma \cup A_\sigma)^c$ contains only standard saddles and is disjoint from $K \cap C$, then C is not taut, by Lemma 4.6. \square

Theorem 5.8 *Let C be a c -incompressible Conway sphere in $S^3 - K$. If C is taut and F_C contains a c -inessential saddle, then bridge position for K is not thin position for K .*

Proof If F_C contains a nonstandard saddle, we are done by Theorem 5.6. If F_C does not contain a nonstandard saddle, we are done by Theorem 5.7. \square

Recall the definition of nested from Section 3.

Definition 5.9 A Conway sphere is *worm-like* if, for every saddle $\sigma = s_1^\sigma \vee s_2^\sigma$, each of s_1^σ and s_2^σ cut C into two twice punctured disks and every saddle in F_C is nested with respect to the same side of C .

Theorem A *If C is a taut c -incompressible Conway sphere in $S^3 - K$ and bridge position for K is thin position, then C is worm-like.*

Proof By Theorem 5.8, F_C contains no c-inessential saddles. By the remark following Lemma 5.1, F_C contains no nonstandard saddles. Thus, there are exactly two outermost disks in F_C each meeting K exactly twice. Since every saddle in F_C is standard, then every saddle σ bounds a monotone disk E_σ . If any E_σ meets K , then one of the two outermost disks in F_C meets K in less than two points. Hence, every E_σ is disjoint from K . If any s_i^σ bounds a disk D in C that is disjoint from K or meets K once, then an outermost saddle in F_D is an inessential or c-inessential saddle. Hence, every s_i^σ cuts C into two twice punctured disks. Let C decompose S^3 into two 3-balls B_1 and B_2 . If F_C contains saddles nested with respect to B_1 and saddles nested with respect to B_2 , then there are adjacent saddles in F_C nested with respect to distinct 3-balls. However, this contradicts C being taut, by Lemma 3.7. Thus, C is worm-like. \square

6 Conway products and bridge inequalities

Let $K_1 \subset S_1^3$ and $K_2 \subset S_2^3$ be links embedded in distinct 3-spheres. For each $i = 1, 2$ let τ_i be arcs in S_i^3 such that $\partial\tau_i \subset K_i$ but τ_i is otherwise disjoint from K_i . Let $\eta(\tau_i)$ be a regular closed neighborhood of τ_i , then $\eta(\tau_i) \cap K_i$ is a trivial tangle and $\partial(\eta(\tau_i))$ is a Conway sphere for K_i . Let $B_i = S_i^3 - \text{int}(\eta(\tau_i))$.

Definition 6.1 Let $K_1 *_c K_2$ (the *generalized Conway product* of K_1 and K_2) denote the link in S^3 formed by removing $\text{int}(\eta(\tau_i))$ from S_i^3 and gluing $\partial(B_1)$ to $\partial(B_2)$ via a homeomorphism which sends $K_1 \cap \partial(B_1)$ to $K_2 \cap \partial(B_2)$.

The image C of $\partial(\eta(\tau_1))$ and $\partial(\eta(\tau_2))$ after their identification, is the Conway sphere of the generalized Conway product.

The isotopy class of $K_1 *_c K_2$ is dependent on the isotopy classes of K_1 and K_2 , the isotopy classes of τ_1 and τ_2 , and the gluing homeomorphism. In fact, there are infinitely many distinct links $K_1 *_c K_2$ for any pair of links K_1 and K_2 . An example of a generalized Conway product is given in Figure 25.

In this section, we will use Theorem A to relate the bridge number of the factor links K_1 and K_2 to the bridge number of their generalized Conway product $K_1 *_c K_2$. To do so, we restrict only to generalized Conway products where C is c-incompressible and bridge position for $K_1 *_c K_2$ is thin position. In addition, if C is taut, then, by Theorem A, C is worm-like. In particular, all saddles of F_C are nested with respect to B_2 , up to labeling. With this labeling, we say K_1 is the *distinguished factor* of $K_1 *_c K_2$.

Let K be a link in S^3 and C be a c -incompressible Conway sphere. If C is taut and bridge position for K is thin position, then, by Theorem A, there are exactly two outermost disks in F_C , D_1 and D_2 , and each D_i meets K exactly twice. We use the following labeling convention: $\{x_1^i, x_2^i\} = K \cap D_i$ and $h(x_1^i) > h(x_2^i)$ for $i = 1, 2$. We will want to keep track of the following properties:

- (1) Is x_j^i a local minimum or maximum of $h|_{K \cap B_1}$ for $i = 1, 2$ and $j = 1, 2$?
- (2) Does $h|_{D_i}$ have a unique local minimum or maximum for $i = 1, 2$? (That is, is D_i a cap or a cup?)

To accomplish this we define a 3-tuple labeling $(x, y, z) \in \{m, M\}^3$ for each D_i where $x = m$ (resp. M) if x_1^i is a minimum (resp. maximum) of $h|_{K \cap B_1}$, $y = m$ (resp. M) if x_2^i is a minimum (resp. maximum) of $h|_{K \cap B_1}$, and $z = m$ (resp. M) if $h|_{D_i}$ has a unique minimum (resp. maximum).

As an example, the disk in Figure 20 is labeled (M, m, m) .

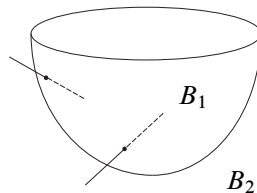

Figure 20

Lemma 6.2 *If $K = K_1 *_c K_2$ is a generalized Conway product such that C is c -incompressible and bridge position for K is thin position, then there is an isotopy of K and C resulting in $h|_K$ having $\beta(K)$ maxima, C being taut, and $h|_K$ having at least one maximum or minimum in B_2 .*

Proof By isotoping C so that F_C has the fewest number of saddles subject to $h|_K$ having $\beta(K)$ maxima, we can assume C is taut. By Theorem A, we can assume C is worm-like. If F_C contains saddles then D_1 and D_2 are defined as in the above discussion. If F_C has no saddles, then let s be a level curve in F_C which separates two points in $C \cap K$ from two others. The two components of $C - s$ are the monotone, twice-punctured disks D_1 and D_2 .

We will proceed by cases using the 3-tuple labeling of D_1 and D_2 . An underscore in a coordinate of a labeling will indicate m or M . (That is, $(m, _, M)$ represents (m, m, M) or (m, M, M)).

Suppose D_i is labeled (M, M, M) or (m, m, m) for $i \in \{1, 2\}$. Let σ be the saddle in F_C such that $\partial(D_i) \subset \sigma$. Since all saddles are nested with respect to B_1 a label of (M, M, M) or (m, m, m) implies σ is removable and contradicts the assumption that C is taut, by Lemma 3.5.

Suppose one of D_i for $i = 1, 2$ is labeled $(m, -, M)$ or $(-, M, m)$. Up to renaming of the disks and reflection in a level sphere, we can assume D_1 has the 3-tuple label $(m, -, M)$. Let σ be the saddle in F_C such that $\partial(D_1) = s_1^\sigma$. Let L be the level surface containing σ . Let γ be the maximal monotone strand of $K \cap B_1$ that contains x_1^1 , so γ ascends from x_1^1 into B_1 .

Suppose C meets γ above x_1 in a point a . If a is contained in D_2 , then D_2 is entirely contained in $B_\sigma \cup A_\sigma$ and $B_\sigma \cup A_\sigma$ contains all four points of $C \cap K$. Since F_C contains only standard saddles, then we contradict C being taut or bridge position for K being thin position, by Lemma 4.6. If a is not contained in D_2 , then a must be x_2^1 . However, this would place x_2^1 higher with respect to h than x_1^1 . This is a contradiction to how we defined x_1^1 . Thus, we may assume that γ is disjoint from C above x_1^1 .

Poke a small neighborhood of the point x_1^1 in C along γ toward and slightly past the maximum of γ as in the proof of Lemma 3.6. This isotopy fixes K and, since γ is disjoint from C above x_1^1 , adds a single saddle τ to F_C . Since K is disjoint from D_1 above x_1^1 , then τ is an inessential saddle. Use the isotopy from Lemma 3.3 to remove τ . This isotopy preserves the number of maxima of $h|_K$ and results in C being taut, but alters D_1 so that its new label is $(M, -, M)$. See Figure 5.

Therefore, we can assume the labels of D_1 and D_2 are both chosen from the set $\{(M, m, m), (M, m, M)\}$. The disks corresponding to these two possible labelings are depicted in Figure 21.

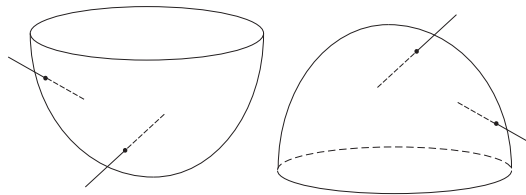

Figure 21

Suppose D_1 is labeled (M, m, M) and D_2 is labeled (M, m, m) . Let α be the component of $K \cap B_2$ with an endpoint x_1^1 . If α contains a maximum or minimum of $h|_K$, then we are done. If not, then α is monotone and the other endpoint of α must be x_2^2 . This leaves x_2^1 and x_1^2 connected by β , a component of $K \cap B_2$. The

monotonicity of α ensures $h(x_2^2) > h(x_1^1)$. Since $h(x_1^1) > h(x_2^1)$, $h(x_1^2) > h(x_2^2)$ and $h(x_2^2) > h(x_1^1)$, then $h(x_1^2) > h(x_2^1)$. However, x_2^1 is labeled m and x_1^2 is labeled M , so there must be both a minimum and a maximum of $h|_K$ in $\beta \subset B_2$. See Figure 22. Thus, $h|_{K \cap B_2}$ contains at least one minimum or maximum. This result follows analogously for the other possible labelings of D_1 and D_2 . \square

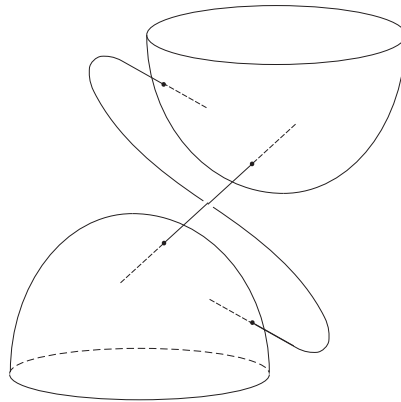

Figure 22

Theorem B *If $K = K_1 *_c K_2$ is a generalized Conway product such that C is c -incompressible and bridge position for K is thin position, then $\beta(K) \geq \beta(K_1) - 1$ where K_1 is the distinguished factor.*

Proof Choose C taut. By Theorem A and Lemma 6.2, we can assume C is worm-like and $h|_K$ has at least one maximum in B_2 (the case where $h|_K$ has one minimum in B_2 is proved analogously). To prove the theorem, we need only prove that the number of maxima of $h|_K$ in B_1 is greater than or equal to $\beta(K_1) - 2$. The theorem will then follow since $\beta(K) = (\text{number of maxima of } h|_K \text{ in } B_1) + (\text{number of maxima of } h|_K \text{ in } B_2)$.

First, we analyze the case where F_C contains no saddles. In this case, there is a level preserving isotopy of S^3 taking C to a standard round 2-sphere. Such an isotopy preserves the number and nature of maxima of $h|_K$ in B_1 . As in Lemma 6.2, a point in $K \cap C$ is labeled with an m if it is a local minimum of $h|_{K \cap B_1}$ and is labeled with an M if it is a local maximum of $h|_{K \cap B_1}$. The link K_1 can be recovered from $K \cap B_1$ by gluing a rational tangle T to $K \cap B_1$ along their common 4-punctured sphere boundary. If more points of $K \cap C$ are labeled with an M , take T to lie above C . If more are labeled with an m , take T to lie below C . See Figure 23. Since the portion

of the rational tangle lying in the region labeled R can be taken to be monotone with respect to h , this rational completion causes the creation of at most two new maxima. The number of maxima of the resulting embedding of K_1 is at most two more than the number of maxima of $h|_K$ in B_1 . Hence, the number of maxima of $h|_K$ in B_1 is greater than or equal to $\beta(K_1) - 2$.

(Note: If F_C has no saddles, we get the analogous estimate that the number of maxima of $h|_K$ in B_2 is greater than or equal to $\beta(K_2) - 2$. Hence, in this special case, we get the additional inequality $\beta(K) \geq \beta(K_1) + \beta(K_2) - 4$.)

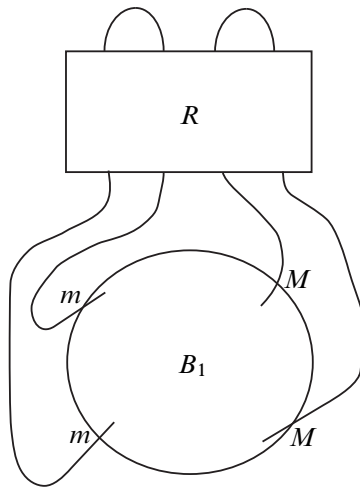

Figure 23

We now assume F_C contains saddles. To establish the desired inequality in this general setting, we build an isotopy of S^3 which takes B_1 to a standard round 3-ball and preserves the number and nature of critical points of $h|_K$ in B_1 . This isotopy, however, does not preserve the number of critical points of $h|_K$ in B_2 . Let D_1 and D_2 be the two outermost disks for F_C . F_{D_1} is a collection of circles and one point corresponding to a maximum of $h|_C$ (if the point is a minimum, the case is analogous). Recall the terminology introduced in Section 2. Let σ be the saddle in F_C such that $D_\sigma = D_1$. By appealing to the proof of Lemma 3.2, we can assume B_σ does not meet $+\infty$. Each point of $K \cap D_1$ (x_1^1 and x_2^1) receives a label of M or m as described above.

Since $h|_{D_1}$ has a maximum as the unique critical point, we can horizontally shrink and vertically lower B_σ until D_1 lies just above D_1^σ . Let C^* be the image of C and D_1^* be the image of D_1 under this isotopy and let p be the unique maximum of $h|_{D_1^*}$. Let J be the level surface containing p . Since we assume the h restricts to a Morse

function on C^* , $J \cap C^*$ consists of the point p and a collection of circles. One such circle c_2 is parallel in C^* to s_2^σ . By isotoping D_1^* close enough to D_1^σ , we can choose a point b in c_2 and an arc α in J that is disjoint from C^* except at its boundary, $\{b, p\}$. Choose another arc β in C^* that does not meet K , has boundary $\{b, p\}$ and is transverse to F_C everywhere except where it passes through $s_1^\sigma \cap s_2^\sigma$. Having made D_1^* sufficiently close to D_1^σ , we can assume α and β cobound a disk F that is vertical with respect to h , disjoint from K , and disjoint from C except along β . Isotope C^* along F to effectively cancel a saddle with a maximum. See Figure 24.

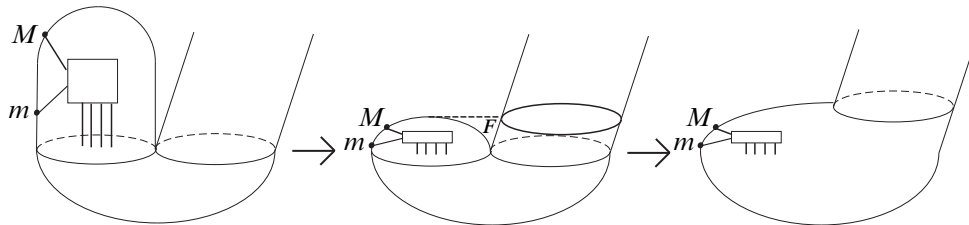

Figure 24

Repeat this process to produce an isotopy that preserves the number and nature of critical points of $h|_{K \cap B_1}$ and takes C to a standard round sphere. By the above argument, the number of maxima of $h|_K$ in B_1 is greater than or equal to $\beta(K_1) - 2$. This completes the proof of the theorem. \square

7 An example

In Figure 25, K_1 is the connect sum of four trefoils and K_2 is an index 2 satellite link of the trefoil. Schubert's seminal work on bridge number tells us that $\beta(K_1) = 5$ and $\beta(K_2) \geq 4$. Since Figure 25 gives a presentation of K_2 with exactly 4 maxima, we conclude that $\beta(K_2) = 4$. The link $K_1 *_c K_2$ depicted in Figure 25 is an index 2 satellite link of the trefoil. Again Schubert's results tell us that $\beta(K_1 *_c K_2) \geq 4$ and again we have a presentation of $K_1 *_c K_2$ with exactly 4 maxima. Hence, $\beta(K_1 *_c K_2) = 4 = \beta(K_1) - 1$. By analyzing the Conway sphere of $K_1 *_c K_2$ in the projection depicted in Figure 25, we see that K_1 is indeed the distinguished factor.

To prove the lower bound in Theorem B is tight it is left to show that C in this example is c -incompressible and the projection of $K_1 *_c K_2$ in Figure 25 is thin. It is easy to show $K_1 *_c K_2$ in the example is prime and, thus, C is c -incompressible. Bridge position for $K_1 *_c K_2$ in this example is thin position. The proof uses standard ideas but has been omitted due to its length. Hence, the bound presented in Theorem B is tight.

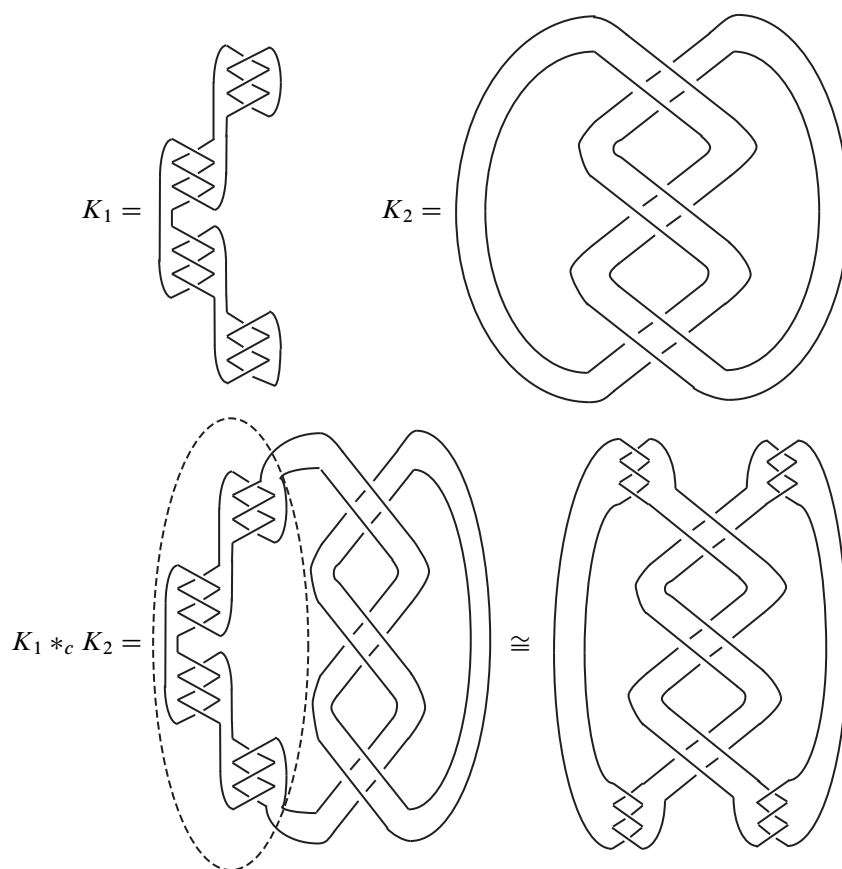

Figure 25

References

- [1] **JH Conway**, *An enumeration of knots and links, and some of their algebraic properties*, from: “Computational Problems in Abstract Algebra (Proc. Conf., Oxford, 1967)”, Pergamon, Oxford (1970) 329–358 MR0258014
- [2] **W B R Lickorish**, *Prime knots and tangles*, Trans. Amer. Math. Soc. 267 (1981) 321–332 MR621991
- [3] **M Scharlemann**, *Thin position in the theory of classical knots*, from: “Handbook of knot theory”, (W Menasco, M Thistlethwaite, editors), Elsevier, Amsterdam (2005) 429–459 MR2179267
- [4] **M Scharlemann, M Tomova**, *Conway products and links with multiple bridge surfaces*, Michigan Math. J. 56 (2008) 113–144 MR433660

- [5] **H Schubert**, *Über eine numerische Knoteninvariante*, Math. Z. 61 (1954) 245–288
MR0072483
- [6] **J Schultens**, *Additivity of bridge numbers of knots*, Math. Proc. Cambridge Philos. Soc.
135 (2003) 539–544 MR2018265

*Department of Mathematics, University of California, Santa Barbara
Santa Barbara, CA 93106*

rcblair@math.ucsb.edu

Received: 13 May 2009 Revised: 15 December 2009

