

# Obtaining genus 2 Heegaard splittings from Dehn surgery

KENNETH L BAKER  
CAMERON GORDON  
JOHN LUECKE

Let  $K'$  be a hyperbolic knot in  $S^3$  and suppose that some Dehn surgery on  $K'$  with distance at least 3 from the meridian yields a 3-manifold  $M$  of Heegaard genus 2. We show that if  $M$  does not contain an embedded Dyck's surface (the closed nonorientable surface of Euler characteristic  $-1$ ), then the knot dual to the surgery is either 0-bridge or 1-bridge with respect to a genus 2 Heegaard splitting of  $M$ . In the case that  $M$  does contain an embedded Dyck's surface, we obtain similar results. As a corollary, if  $M$  does not contain an incompressible genus 2 surface, then the tunnel number of  $K'$  is at most 2.

57M27

## 1 Introduction

Let  $M = K'(\gamma)$  be the manifold obtained by Dehn surgery on a knot  $K'$  in  $S^3$  along a slope  $\gamma$ . In  $K'(\gamma)$ , the core of the attached solid torus is a knot which we denote by  $K$ . It is natural to consider the properties of  $K$  as a knot in  $M$ . In this paper we are interested in the relationship between  $K$  and the Heegaard splittings of  $M$ ; more specifically, if  $\hat{F}$  is a Heegaard surface in  $M$  of genus  $g$ , what can we say about the bridge number  $br(K)$  of  $K$  with respect to  $\hat{F}$ ? Assume  $K'$  is a hyperbolic knot, meaning that its complement  $S^3 - K'$  admits a complete Riemannian metric of constant sectional curvature  $-1$ . It follows from Rieck and Sedgwick [31] (see also Moriah and Rubinstein [28] and Rieck [30]) that for all but finitely many slopes  $\gamma$ ,  $K$  can be isotoped to lie on  $\hat{F}$ , ie  $br(K) = 0$ . Let  $\Delta = \Delta(\gamma, \mu)$  be the distance of the surgery, in other words the minimal geometric intersection number on  $\partial N(K')$  of the slope  $\gamma$  and the meridian  $\mu$  of  $K'$ . Since the trivial Dehn surgery  $K'(\mu) = S^3$  represents the maximal possible degeneration of Heegaard genus, one would expect the Heegaard splittings of  $K'(\gamma)$  to reflect those of the exterior of  $K'$  as  $\Delta$  gets large. Indeed, it follows from [30] that for any Heegaard surface  $\hat{F}$  of  $K'(\gamma)$  of genus  $g$  if  $\Delta \geq 18(g + 1)$  then  $br(K) = 0$ , and so after at most one stabilization  $\hat{F}$  is isotopic to

a Heegaard surface for the exterior of  $K'$ . Also, in [3] we show that if  $\Delta \geq 2$ ,  $\gamma$  is not a boundary slope for  $K'$ , and  $M$  has a strongly irreducible Heegaard splitting of genus  $g$ , then the bridge number  $br(K)$  of  $K$  with respect to *some* genus  $g$  splitting of  $M$  is bounded above by a universal linear function of  $g$ . In contrast, this is not true for  $\Delta = 1$ : By Teragaito [34] there exists a family of knots  $K'_n$  and a  $\gamma$  with  $\Delta(\gamma, \mu) = 1$  such that  $K'_n(\gamma)$  is the same small Seifert fiber space  $M$  for all  $n$ , and we show in [2] that the set of bridge numbers of the corresponding cores  $K_n$  with respect to any genus 2 Heegaard splitting of  $M$  is unbounded.

Turning to small values of  $g$ , note that the impossibility of getting  $S^3$  by nontrivial Dehn surgery on a nontrivial knot (see the second and third authors' [19]) can be expressed as saying that if  $g = 0$  and  $\Delta > 0$  then  $br(K) = 0$ . When  $g = 1$ ,  $K'(\gamma)$  is a lens space and here the Cyclic Surgery Theorem (see Culler, Shalen, the second and third authors' [9]) says that if  $\Delta > 1$  then  $K'$  is a torus knot, which is easily seen to imply  $br(K) = 0$ , while if  $\Delta = 1$  and  $K'$  is hyperbolic the Berge Conjecture [4] asserts that  $br(K) = 1$ . In the present paper we consider the case  $g = 2$  and show that if  $\Delta > 2$  then, generically,  $br(K) \leq 1$  (with respect to some genus 2 splitting). In fact we consider 1-sided as well as 2-sided genus 2 Heegaard splittings of  $M$ ; recall that such a splitting is defined by a closed (connected) nonorientable surface of Euler characteristic  $-1$  in  $M$ , the complement of an open regular neighborhood of which is a genus 2 handlebody. Such a surface is a connected sum of three projective planes and is also known as a *cross cap number 3 surface* or as a *Dyck's surface*; in this paper we shall adopt the latter terminology.

**Theorem 2.4** *Let  $K'$  be a hyperbolic knot in  $S^3$  and assume  $M = K'(\gamma)$  has a 1- or 2-sided Heegaard splitting of genus 2. Assume that  $\Delta(\gamma, \mu) \geq 3$ , where  $\mu$  is the meridian of  $K'$ . Denote by  $K$  the core of the attached solid torus in  $M$ . Then either:*

- (1)  $K$  is 0-bridge or 1-bridge with respect to a 1- or 2-sided, genus 2 Heegaard splitting of  $M$ . In this case, the tunnel number of  $K'$  is at most two.
- (2)  $M$  contains a Dyck's surface,  $\widehat{S}$ , such that the orientable genus 2 surface  $\widehat{F}$  that is the boundary of a regular neighborhood of  $\widehat{S}$  is incompressible in  $M$ . Furthermore,  $K$  can either be isotoped onto  $\widehat{S}$  as an orientation-reversing curve or can be isotoped to intersect  $\widehat{S}$  once. In the latter case, the intersection of  $\widehat{F}$  with the exterior of  $K$  (which is also the exterior of  $K'$ ) gives a twice-punctured, incompressible, genus 2 surface in that exterior.

Conclusion (2) is an artifact of the proof and probably not necessary, but allowing it simplifies an already lengthy argument. Similarly, the assumption that  $K'$  is hyperbolic simplifies the argument; we will consider the case where  $K'$  is a satellite knot elsewhere.

As a warning, the Heegaard splitting of conclusion (1) may be different than the one you started with. For example, starting with a 2-sided genus 2 Heegaard splitting of  $K'(\gamma)$ , the proof of [Theorem 2.4](#) may produce a 1-sided splitting with respect to which  $K$  is 1-bridge.

[Theorem 2.4](#) fails dramatically when  $\Delta = 1$ . For the Teragaito examples [34] mentioned above, [Theorem A.2](#) of the [appendix](#) shows that the ambient Seifert fiber space,  $M$ , contains no Dyck's surface; thus conclusion (2) of [Theorem 2.4](#) does not apply and every genus 2 splitting of  $M$  is 2-sided. On the other hand, [2] shows there are knots in the Teragaito family with arbitrarily large bridge number with respect to any genus 2 splitting of  $M$ . In the same vein, [2] gives examples of families of knots in  $S^3$ , where each member of the family admits an integral surgery that is the same hyperbolic manifold  $M$  and where the genus 2 bridge numbers of the corresponding family of core curves in  $M$  are unbounded. In these examples  $M$  can be chosen so that it contains no Dyck's surface.

[Theorem 2.4](#) says that there exists a Heegaard splitting of  $M$  with respect to which  $K$  is at most 1-bridge. If the bridge number is more than one, the proof of [Theorem 2.4](#) constructs a new genus 2 splitting with respect to which the bridge number is smaller. By keeping a track of when such a modification is necessary, we see that the proof typically shows that  $K$  is at most 1-bridge with respect to any genus 2 splitting of  $M$ . We make this precise in [Theorem 2.6](#) below. For this we need the following definitions.

**Definition 1.1** Let  $H_B \cup_{\hat{F}} H_W$  be a genus 2 (2-sided) Heegaard splitting of  $M$ . Assume there is a Möbius band on one side of the Heegaard surface  $\hat{F}$ , whose boundary is a primitive curve on the other side of  $\hat{F}$ . A new Heegaard splitting of  $M$ , of the same genus, can be formed by removing a neighborhood of the Möbius band from one side of  $\hat{F}$  and adding it to the other side. We say that this new splitting is obtained from the old by *adding/removing a Möbius band*.

**Definition 1.2** Let  $M$  be a Seifert fiber space over the 2-sphere with three exceptional fibers. A *vertical* Heegaard splitting of  $M$  is a genus 2 splitting for which one of the Heegaard handlebodies is gotten by tubing together the neighborhoods of two exceptional fibers, where the tube connecting them is the neighborhood of a cocore arc of a vertical annulus connecting the neighborhoods of these exceptional fibers.

**Theorem 2.6** Let  $K'$  be a hyperbolic knot in  $S^3$ . Let  $H_B \cup_{\hat{F}} H_W$  be a genus 2 (2-sided) Heegaard splitting of  $M = K'(\gamma)$ . Assume that  $\Delta(\gamma, \mu) \geq 3$ , where  $\mu$  is the meridian of  $K'$ . Furthermore assume that  $M$  does not contain a Dyck's surface. Denote by  $K$  the core of the attached solid torus in  $M$ . Then either:

- (1)  $K$  is 0–bridge or 1–bridge with respect to a Heegaard splitting of  $M$  obtained from  $H_B \cup_{\hat{F}} H_W$  by a (possibly empty) sequence of adding/removing Möbius bands; or
- (2)  $M$  is a Seifert fiber space over the disk with three exceptional fibers, one of which has order 2 or 3, and  $K$  is 0–bridge or 1–bridge with respect to a Heegaard splitting gotten from a vertical Heegaard splitting of the Seifert fiber space  $M$  which has been changed by a (possibly empty) sequence of adding/removing Möbius bands; or
- (3)  $M$  is  $n/2$ –surgery on a trefoil knot,  $n$  odd, and  $K$  is 0–bridge or 1–bridge with respect to the Heegaard splitting on  $M$  coming from the genus 2 splitting of the trefoil knot exterior. Note that in this case  $M$  is a Seifert fiber space over the 2–sphere with three exceptional fibers, one of order 2 and a second of order 3.

In particular, if  $M$  is not a Seifert fiber space over the 2–sphere with an exceptional fiber of order 2 or 3, and if the Heegaard surface  $\hat{F}$  has no Möbius band on one side whose boundary is a primitive curve on the other, then  $K$  must be 0–bridge or 1–bridge with respect to the given splitting  $H_B \cup_{\hat{F}} H_W$ .

**Remark 1.3** The situations in which the Heegaard splitting  $H_B \cup_{\hat{F}} H_W$  must be altered in [Theorem 2.6](#) are special. The situation when  $M$  contains a Dyck’s surface is discussed in more detail below, for example in [Theorem 7.2](#) (see also the [appendix](#)). It is conjectured that the second and third conclusions of [Theorem 2.6](#) never hold, that a Seifert fiber space never arises by nonintegral surgery on a hyperbolic knot. Finally, the existence of a Möbius band in one Heegaard handlebody of  $H_B \cup_{\hat{F}} H_W$  whose boundary is primitive on the other is a special case of this Heegaard splitting having Hempel distance 2 (see Hempel [\[25\]](#) and Thompson [\[36\]](#)), which also places restrictions on what  $M$  can be. Presumably these exceptions are artifacts of the proof, and that in fact  $K$  is at most 1–bridge with respect to any genus 2 splitting when  $\Delta \geq 3$ .

Our results give information on the relationship between the Heegaard genus of  $M$  and that of  $X = S^3 - N(K')$ , the exterior of  $K'$ . Recall that a Heegaard splitting of  $X$  is a decomposition  $X = V \cup_S W$ , where  $V$  is a handlebody with  $\partial V = S$  and  $W$  is a compression body with  $\partial W = S \sqcup \partial X$ . The *Heegaard genus*  $g(X)$  of  $X$  is the minimal genus of  $S$  over all such decompositions.

In this context one often talks about the *tunnel number*  $t(K')$  of  $K'$ , the minimum number of arcs (“tunnels”) that need to be attached to  $K'$  so that the complement of an open regular neighborhood of the resulting 1–complex is a handlebody. It is easy to see

that  $g(X) = t(K') + 1$ . For any slope  $\gamma$ ,  $V \cup_{\mathcal{S}} W(\gamma)$  is a Heegaard splitting of  $M = K'(\gamma)$ ; in particular  $g(M) \leq g(X)$ . In fact, by Rieck and Sedgwick [32], generically we have  $g(M) = g(X)$ . More precisely, recall that for all but finitely many slopes  $\gamma$ ,  $br(K) = 0$  with respect to any Heegaard surface  $\hat{F}$  of  $M$ . Taking  $\hat{F}$  to have minimal genus, it is then easy to see that when  $br(K) = 0$  either  $g(M) = g(X) = t(K') + 1$  or  $g(M) = g(X) - 1 = t(K')$ . See Rieck [30] for details. By [32], the second possibility can happen for only a finite number of lines of slopes (where a *line* of slopes is a set of slopes  $\gamma$  such that  $\Delta(\gamma, \gamma_0) = 1$  for some fixed slope  $\gamma_0$ ). We know no examples where the Heegaard genus of  $K'(\gamma)$  ( $\gamma \neq \mu$ ) is less than  $t(K')$ .

**Question** Is  $t(K') \leq g(K'(\gamma))$  for all  $\gamma \neq \mu$ ?

Now it is easy to see that an upper bound on  $br(K)$  in  $M$ , with respect to a 1– or 2–sided Heegaard surface, gives an upper bound on  $t(K')$ . In particular part (1) of [Theorem 2.4](#) gives:

**Corollary 1.4** *Let  $K'$  be a hyperbolic knot in  $S^3$  and suppose  $K'(\gamma)$  has Heegaard genus 2 and does not contain an incompressible genus 2 surface, where  $\Delta(\gamma, \mu) \geq 3$ . Then the tunnel number of  $K'$  is at most 2.*

[Corollary 1.4](#) is sharp: there exist hyperbolic tunnel number 2 knots  $K'$  having non-Haken Dehn surgeries  $K'(\gamma)$  of Heegaard genus 2 with  $\Delta(\gamma, \mu)$  arbitrarily large. To see this, let  $K'$  be a knot that lies on a standard genus 2 Heegaard surface in  $S^3$ , and let  $\lambda$  be the (integral) slope on  $\partial N(K')$  induced by the surface. Then for any  $\gamma$  such that  $\Delta(\gamma, \lambda) = 1$ ,  $K'(\gamma)$  has a (2–sided) Heegaard splitting of genus 2. Note that the tunnel number of  $K'$  is at most 2; on the other hand one can arrange that it is 2, and that  $K'(\gamma)$  is non-Haken. Explicit examples are provided by the pretzel knots  $K' = P(p, q, r)$ , where  $|p|, |q|, |r|$  are distinct odd integers greater than 1. Such a knot  $K'$  lies on the standard genus 2 surface in  $S^3$ , with  $\lambda$  the canonical longitude (slope 0). Hence  $K'(\gamma)$  has a genus 2 Heegaard splitting for all  $\gamma$  of the form  $1/n$  (with the usual parametrization of slopes for knots). Note that  $\Delta(\gamma, \mu) = |n|$  can be arbitrarily large. By Trotter [38],  $K'$  is noninvertible, and therefore does not have tunnel number 1. The double branched cover of  $K'$  is a Seifert fiber space over  $S^2$  with three exceptional fibers, which does not contain an incompressible surface, and hence by Litherland and the second author [17]  $S^3 - K'$  contains no closed essential surface. It follows that  $K'$  is hyperbolic. It also follows that if  $K'(\gamma)$  is Haken then  $\gamma$  is a boundary slope. Since any knot has only finitely many boundary slopes (Hatcher [24]),  $K'(1/n)$  will be non-Haken for all but finitely many values of  $n$ . (Other pretzel knots provide similar examples, using Morimoto, Sakuma and Yokota [29] to ensure that they have tunnel number 2.)

One reason we are interested in the genus 2 case is that this includes the situation where  $M$  is a Seifert fiber space over  $S^2$  with three exceptional fibers. Here it is expected that (when  $K'$  is hyperbolic)  $\Delta = 1$ , although to date the best known upper bound is 8; see Lackenby and Meyerhoff [26]. The techniques of this article ought to enable further restrictions on nonintegral, Seifert fibered surgeries on hyperbolic knots in  $S^3$ . We will explore this elsewhere.

We derived the bound on the tunnel number  $t(K')$  from the bound on the bridge number  $br(K)$  in  $K'(\gamma)$  given in [Theorem 2.4](#). We point out that the latter bound is stronger: for example for any  $t \geq 1$  there are knots in  $S^3$  with tunnel number  $t$  whose bridge number with respect to the genus  $t$  splitting of  $S^3$  is arbitrarily high; see Minsky, Moriah and Schleimer [27]. Also, although Teragaito's family [34] of knots mentioned above have tunnel number 2, we show [2] that the set of their bridge numbers with respect to any genus 2 Heegaard splitting of the small Seifert fiber space is unbounded. At any rate, the bound on bridge number in [Theorem 2.4](#) allows us to use a result of Tomova [37] to get a statement about the distance of splittings of exteriors of knots with genus 2 Dehn surgeries. If  $S$  is a Heegaard surface for some 3-manifold, we denote by  $d(S)$  the (Hempel) distance of the corresponding splitting; see Hempel [25].

**Corollary 1.5** *Let  $K'$  be a hyperbolic knot in  $S^3$  whose exterior has a Heegaard splitting  $S$  with  $d(S) > 6$ . Let  $\gamma$  be a slope with  $\Delta(\gamma, \mu) \geq 3$ , where  $\mu$  is a meridian of  $K'$ , and suppose the manifold  $K'(\gamma)$  does not contain a Dyck's surface and has Heegaard genus 2. Then  $S$  has genus 2.*

Thus the distance of a splitting of a knot exterior is putting a limit on the degeneration of Heegaard genus under Dehn filling. For instance, this applies to the examples of Minsky, Moriah and Schleimer [27]. First note that the condition that  $K'(\gamma)$  not contain a Dyck's surface (or indeed any closed nonorientable surface) can be easily ensured by taking  $\gamma = p/q$  with  $p$  odd. Now by [27], for any  $g \geq 3$ , there are knots  $K'$  in  $S^3$  whose exteriors have genus  $g$  Heegaard splittings  $S$  with  $d(S) > 6$ , in fact with  $d(S)$  arbitrarily large (such knots are necessarily hyperbolic). [Corollary 1.5](#) says that for such a knot  $K'$ , if  $q \geq 3$  and  $p$  is odd,  $K'(p/q)$  does not have Heegaard genus 2.

**Proof of Corollary 1.5** Let  $K', \gamma, S$  be as in the hypothesis. By [Theorem 2.4](#), the bridge number of  $K$  with respect to some genus 2 Heegaard surface  $\hat{F}$  of  $K'(\gamma)$  is at most 1. Thus  $K$  can be put in bridge position with respect to  $\hat{F}$  so that  $2 - \chi(\hat{F} - K) = 2 - (-2 - 2) = 6$ . Since  $d(S) > 6$  by assumption, the main result of Tomova [37] implies that, in  $K'(\gamma)$ ,  $\hat{F}$  is isotopic to a stabilization of  $S$ . Hence  $S$  has genus 2 (and  $\hat{F}$  is isotopic to  $S$  in  $K'(\gamma)$ ).  $\square$

In the course of proving [Theorem 2.4](#), we consider Dehn surgeries that produce Dyck's surfaces, leading to conclusion (2) of that theorem. If a knot  $K'$  in  $S^3$  has a maximal Euler characteristic spanning surface  $S$  with  $\chi(S) = -1$  (so that  $K'$  has genus 1 or cross cap number 2) then surgery on  $K'$  along a slope  $\gamma$  of distance 2 from  $\partial S$  produces a manifold with Dyck's surface embedded in it. There is a Möbius band embedded in the surgery solid torus whose boundary coincides with  $\partial S$  so that together they form an embedded Dyck's surface  $\tilde{S}$ . The core of the surgery solid torus is the core of the Möbius band, and hence the surgered knot lies as a simple closed curve on  $\tilde{S}$ . Furthermore, such a surgery slope  $\gamma$  may be chosen so that it has any desired odd distance  $\Delta = \Delta(\gamma, \mu)$  from the meridian  $\mu$  of  $K'$ . Any knot with (Seifert) genus more than 1 and crosscap number 3 has an integral surgery containing a Dyck's surface that does not come from this construction, and there are many such hyperbolic knots, the smallest being  $6_3$  (see eg the tables of Cha and Livingston [\[8\]](#)). However, we conjecture that this is the only way a Dyck's surface arises from a nonintegral (ie  $\Delta > 1$ ) Dehn surgery on a hyperbolic knot:

**Conjecture 7.1** *Let  $K'$  be a hyperbolic knot in  $S^3$  and assume that  $K'(\gamma)$  contains an embedded Dyck's surface. If  $\Delta(\gamma, \mu) > 1$ , where  $\mu$  is a meridian of  $K'$ , then there is an embedded Dyck's surface,  $\hat{S} \subset K'(\gamma)$ , such that the core of the attached solid torus in  $K'(\gamma)$  can be isotoped to an orientation-reversing curve in  $\hat{S}$ . In particular,  $K'$  has a spanning surface with Euler characteristic  $-1$ .*

In [Section 7](#), we prove the following, which goes a long way towards verifying this conjecture.

**Theorem 7.2** *Let  $K'$  be a hyperbolic knot in  $S^3$  and assume that  $M = K'(\gamma)$  contains an embedded Dyck's surface. If  $\Delta(\gamma, \mu) > 1$ , where  $\mu$  is a meridian of  $K'$ , then there is an embedded Dyck's surface in  $M$  that intersects the core of the attached solid torus in  $M$  transversely once.*

[Conjecture 7.1](#) fits in well with earlier results on small surfaces in Dehn surgery on a knot in the 3–sphere. When  $\Delta \geq 2$ ,  $M$  cannot contain an essential sphere [\[18\]](#), an embedded projective plane ([\[18\]](#) and [\[9\]](#)), or an embedded Klein bottle [\[21\]](#). When  $\Delta \geq 3$  (as in fact must be the case when  $M$  contains an embedded, closed, nonorientable surface and  $\Delta > 1$ ),  $M$  cannot contain an essential torus [\[20\]](#).

## 1.1 Sketch of the argument for [Theorem 2.4](#)

The idea of the proof of [Theorem 2.4](#) is as follows. Assume  $M = K'(\gamma)$  has a 2–sided, genus 2 Heegaard splitting. Assume  $K$  has the smallest bridge number with respect



to this splitting, among all 2–sided, genus 2 splittings of  $M$ . The typical situation is when this bridge position of  $K$  is also a thin position of  $K$  with respect to this splitting (see Section 2.1). This thin presentation of  $K$  in  $M$  and one of  $K'$  in  $S^3$  allow us to find a genus 2 Heegaard surface  $\hat{F}$  of the splitting of  $M$  and a genus 0 Heegaard surface  $\hat{Q}$  of  $S^3$  such that  $F = \hat{F} - N(K)$  and  $Q = \hat{Q} - N(K')$  intersect essentially. The arcs of  $F \cap Q$  form graphs  $G_F, G_Q$  on  $\hat{F}, \hat{Q}$ . Then  $t = |K \cap \hat{F}|$  is twice the bridge number of  $K$  in  $M$ . We show that  $t \leq 2$ , thereby implying that  $K$  is 0–bridge or 1–bridge with respect to this splitting. We do this typically by showing that if  $t > 2$  then we can thin the presentation (ie find one with smaller bridge number) with respect to some genus 2 Heegaard splitting in  $M$ . To find such “thinnings” of  $K$ , we show that  $G_Q$  has a special subgraph,  $\Lambda$ , called a great 2–web (Section 5.1). Disk faces of  $\Lambda$  are thought of as disks properly embedded  $M - N(K \cup \hat{F})$  (at least when there are no simple closed curves of  $F \cap Q$ ). Within  $\Lambda$  we look for configurations of small faces that can be used to locate  $K$  in its bridge presentation with respect to  $\hat{F}$ . For example, a configuration called an “extended Scharlemann cycle” (an ESC, see Figure 1) leads to a “long Möbius band” (Figure 3), which, when long enough, leads to an essential torus in  $M$  (which does not happen since  $\Delta \geq 3$ ) or to a thinning of  $K$  (eg Lemmas 8.5 and 8.10). For  $t \leq 6$ , configurations of bigons and trigons at “special vertices” of  $\Lambda$  (Section 5.3) are often used to construct a new Heegaard splitting of  $M$  with respect to which  $K$  has smaller bridge number.

As a note to the reader, the generic argument (showing that  $K$  is at most 4–bridge with respect to some genus 2 splitting of  $M$ ) is given in Sections 2, 4, 5.1, 5.2, 8 and 9. The arguments get more complicated as the supposed bridge number of  $K$  in  $M$  gets smaller. In particular, almost half of the current paper is from Section 13 on, showing that the minimal bridge number of  $K$  is not 2 (ie  $t \neq 4$ ).

## 1.2 Notation

By  $N(\cdot)$  we denote a regular open neighborhood or its subsequent closure as the situation dictates.

Let  $Y$  be a subset of the manifold  $X$ , typically a properly embedded submanifold (such as an arc or loop in a surface or a surface or handlebody in a 3–manifold). By  $X \setminus Y$  we denote  $X$  *chopped* or *cut* along  $Y$ . That is,  $X \setminus Y$  may be viewed as either  $X - \text{Int } N(Y)$  or the closure of  $X - Y$  in the path metric.

For  $Y$  a connected codimension 1 properly embedded submanifold of  $X$ , any newly created maximal connected submanifold of the boundary of  $X \setminus Y$  is an *impression* of  $Y$ . In other words, an impression of  $Y$  is a component of the closure of  $\partial(X \setminus Y) - \partial X$ . Note that the impressions of  $Y$  form a double cover of  $Y$ . Suitably identifying



$\partial(X \setminus Y)$  along them will reconstitute  $X$  with  $Y$  inside. Alternatively  $X$  with  $Y$  may be reconstituted by suitably attaching  $N(Y)$  to  $X \setminus Y$ .

### 1.3 Acknowledgements

The authors would like to thank the referee for detailed and helpful comments. In the course of this work KB was partially supported by NSF Grant DMS-0239600, by the University of Miami 2011 Provost Research Award, and by a grant from the Simons Foundation (#209184 to Kenneth Baker). KB would also like to thank the Department of Mathematics at the University of Texas at Austin for its hospitality during his visits. These visits were supported in part by NSF RTG Grant DMS-0636643.

## 2 Thin-bridge position, $G_Q$ , $G_F$ , the proof of Theorem 2.4

### 2.1 Heegaard splittings, thin position and bridge position

Given a (2-sided) Heegaard surface  $\Sigma$  of a closed 3-manifold  $Y$  there is a product  $\Sigma \times \mathbb{R} \subset Y$  so that  $\Sigma = \Sigma \times \{0\}$  and the complement of the product is the union of spines for each of the two handlebodies. This defines a height function on the complement of spines for each of the handlebodies. Consider all the circles  $C$  embedded in the product that are Morse with respect to the height function and represent the knot type of  $J$ . The following terms are all understood to be taken with respect to the Heegaard splitting.

Following [13] (see also [35]), the *width* of an embedded circle  $C$  is the sum of the number of intersections  $|C \cap \Sigma \times \{y_i\}|$ , where one regular value  $y_i$  is chosen between each pair of consecutive critical values. The *width* of a knot  $J$  is the minimum width of all such embeddings. However, if  $J$  can be isotoped to a curve embedded in a level surface  $\Sigma \times \{y\}$ , we define such an embedding as having width 0. An embedding realizing the width of  $J$  is a *thin position* of  $J$ , and  $J$  is said to be *thin*. If the critical point immediately below  $y_i$  is a minimum and the critical point immediately above  $y_i$  is a maximum, then the level  $\Sigma \times \{y_i\}$  is a *thick level*.

The minimal number of maxima among Morse embeddings of  $C$  is the *bridge number* of  $J$ , and denoted  $br(J)$ . An embedding realizing the bridge number of  $J$  may be ambient isotoped so that all maxima lie above all minima, without introducing any more extrema. The resulting embedding is a *bridge position* of  $J$ , and  $J$  is said to be *bridge*. If  $J$  can be isotoped into a level surface  $\Sigma \times \{y\}$ , we define such an embedding as having bridge number 0.

With  $J$  in bridge position, the arcs of  $J$  intersecting a Heegaard handlebody are collectively  $\partial$ -parallel. There is an embedded collection of disks in the handlebody such that the boundary of each is formed of one arc on  $\Sigma$  and one arc on  $J$ . A single such disk is called a *bridge disk* for that arc of  $J$ , and the arc is said to be *bridge*.

A thin position for a knot may have smaller width than that of its bridge position, with respect to the same Heegaard splitting. That is, thin position may not be bridge position. However, this only happens when the meridian of the knot in the ambient manifold is a boundary slope of the knot exterior.

**Definition 2.1** Let  $E$  be an orientable 3-manifold with a single torus boundary. Let  $\gamma$  be the isotopy class of a nontrivial curve on  $\partial E$ . Then  $\gamma$  is said to be a *boundary slope* for  $E$  if there is an incompressible,  $\partial$ -incompressible, orientable surface,  $P$ , properly embedded in  $E$  with nonempty boundary, such that each component of  $\partial P$  is in isotopy class  $\gamma$ .  $\gamma$  is said to be a  *$g$ -boundary slope* if there is such a surface  $P$  with genus at most  $g$ .

**Lemma 2.2** Assume  $J$  is a knot in a 3-manifold  $M$ . If  $J$  has a thin position which is not a bridge position with respect to a genus  $g$  Heegaard splitting of  $M$ , then the meridian of  $J$  is a  $g$ -boundary slope for the exterior of  $J$ .

**Proof** This is proved in [35] when  $g = 0$ . The same proof works here. We sketch it for the convenience of the reader.

Let  $\Sigma$  be the Heegaard surface of a genus  $g$  splitting of  $M$  with respect to which  $J$  is in thin position but not bridge position. Then there must be a *thin level*; a level surface  $\Sigma \times \{y\}$  at a regular value of the height function such that the first critical level below the surface is a maximum and the first critical level above the surface is a minimum. There can be no bridge disks for  $J$  to the thin level surface, else such a disk would give rise to a thinner presentation of  $J$ . Maximally compress  $(\Sigma \times \{y\}) - N(J)$  in the exterior of  $J$ . Either some component of the result is an incompressible,  $\partial$ -incompressible surface of genus at most  $g$  whose boundary components are meridians of  $J$ , or the result is a nonempty collection of boundary parallel annuli along with some closed surfaces. But each boundary parallel annulus gives rise to a bridge disk of  $J$  onto  $\Sigma \times \{y\}$ , which is not possible. Thus the meridian is a  $g$ -boundary slope for the exterior of  $J$ .  $\square$

We tend to consider the situation where thin position is not bridge position as nongeneric. For example we have the following useful result.

**Lemma 2.3** Let  $K'$  be a hyperbolic knot in  $S^3$  with meridian  $\mu$ . Assume there is a Heegaard splitting of  $M = K'(\gamma)$  with respect to which the core of the attached solid torus,  $K$ , has a thin position which is not a bridge position. If  $\Delta(\gamma, \mu) \geq 2$  then  $M$  is not Seifert fibered.

**Proof** Assume  $M$  is Seifert fibered. By [5, Corollary 1.7] or [22, Theorem 1.1],  $M$  is non-Haken. Considering  $K$  in  $M$ , Lemma 2.2 says that  $\gamma$  is a boundary slope for the exterior of  $K$ . But this contradicts [9, Theorem 2.0.3] ( $M$  is irreducible and  $K(\mu)$  is non-Haken).  $\square$

## 2.2 The proof of Theorem 2.4

We now give the proof of the main theorem, which defines the graphs  $G_Q, G_F$  studied throughout the rest of the paper.

**Theorem 2.4** *Let  $K'$  be a hyperbolic knot in  $S^3$  and assume  $M = K'(\gamma)$  has a 1– or 2–sided Heegaard splitting of genus 2. Assume that  $\Delta(\gamma, \mu) \geq 3$ , where  $\mu$  is the meridian of  $K'$ . Denote by  $K$  the core of the attached solid torus in  $M$ . Then either:*

- (1)  $K$  is 0–bridge or 1–bridge with respect to a 1– or 2–sided, genus 2 Heegaard splitting of  $M$ . In this case, the tunnel number of  $K'$  is at most two.
- (2)  $M$  contains a Dyck’s surface,  $\widehat{S}$ , such that the orientable genus 2 surface  $\widehat{F}$  that is the boundary of a regular neighborhood of  $\widehat{S}$  is incompressible in  $M$ . Furthermore,  $K$  can either be isotoped onto  $\widehat{S}$  as an orientation-reversing curve or can be isotoped to intersect  $\widehat{S}$  once. In the latter case, the intersection of  $\widehat{F}$  with the exterior of  $K$  gives a twice-punctured, incompressible, genus 2 surface in that exterior.

**Remark 2.5** In this proof and throughout the article, since  $K'$  is hyperbolic and  $\Delta \geq 3$ ,  $M$  cannot contain an essential sphere [18], an embedded projective plane ([18] and [9]), an embedded Klein bottle [21], or an essential torus [20].

**Proof** Let  $K'$  be a hyperbolic knot in  $S^3$ , and let  $M = K'(\gamma)$ . Assume  $\Delta = \Delta(\gamma, \mu) \geq 3$ . Let  $K$  be the core of the attached solid torus in  $M = K'(\gamma)$ .

If  $M$  contains an embedded Dyck’s surface, the theorem follows from Corollary 7.14. This includes the case where  $M$  has a 1–sided genus 2 Heegaard splitting. We assume hereafter that  $M$  contains no embedded Dyck’s surface.

Thus  $M$  has 2–sided, genus 2 Heegaard splitting. Note that any such splitting is irreducible, since  $M$  is neither a lens space nor a connected sum ([9] and [18]). Consequently, such a splitting is also strongly irreducible (the disjoint disks can be taken to be separating, hence to have isotopic boundaries).

Assume we have a genus 2 Heegaard splitting of  $M$  for which  $K$  does not have bridge number 0. Take  $K$  to be in bridge position. By Theorem 2.7, we may assume that  $K$

is also in thin position with respect to this Heegaard splitting of  $M$ . In  $S^3$ , put  $K'$  into thin position with respect to the genus 0 Heegaard splitting. By [30, Theorem 6.2] (by assumption  $K, K'$  cannot be isotoped onto their Heegaard surfaces), there exist thick level surfaces,  $\widehat{F}$  of  $M$  and  $\widehat{Q}$  of  $S^3$  such that:

(\*) Each arc of  $F \cap Q$  is essential in each of  $F = \widehat{F} - N(K)$  and  $Q = \widehat{Q} - N(K')$ .

As the exterior of  $K'$  is irreducible, after an isotopy we may assume:

(\*\*) There are no simple closed curves of  $F \cap Q$  trivial in both  $F$  and  $Q$ .

On  $\widehat{Q}$  and  $\widehat{F}$  form the *fat vertexed graphs of intersection*  $G_Q$  and  $G_F$ , respectively, consisting of the *fat vertices* that are the disks  $\overline{N(K')} \cap \widehat{Q}$  and  $\overline{N(K)} \cap \widehat{F}$  and *edges* that are the arcs of  $F \cap Q$ .

Choosing an orientation on  $K \subset M$ , we may number the intersections of  $K$  with  $\widehat{F}$ , and hence the vertices of  $G_F$ , from 1 to  $t = |K \cap \widehat{F}|$  in order around  $K$ . Similarly, if  $|K' \cap \widehat{Q}| = u$ , by choosing an orientation on  $K' \subset S^3$  we may number the intersections of  $K'$  with  $\widehat{Q}$  and hence the vertices of  $G_Q$  from 1 to  $u$  in order around  $K'$ .

Each component of  $\partial F$  intersects each component of  $\partial Q$  a total of  $\Delta$  times. Thus a vertex of  $G_Q$  has valence  $\Delta t$  and a vertex of  $G_F$  has valence  $\Delta u$ . Since each component of  $\partial F \cap \partial Q$  is an endpoint of an arc of  $F \cap Q$ , each endpoint of an edge in  $G_Q$  may be labeled with the vertex of  $G_F$  whose boundary contains the endpoint. Thus around the boundary of each vertex of  $G_Q$  the labels  $\{1, \dots, t\}$  appear in order  $\Delta$  times. Similarly around the boundary of each vertex of  $G_F$  the labels  $\{1, \dots, u\}$  appear in order  $\Delta$  times.

Now  $t/2$  is the bridge number of  $K$  with respect to the Heegaard surface  $\widehat{F}$ . We show that  $t \leq 2$ , thereby implying that  $K$  is 0-bridge or 1-bridge with respect to this genus 2 splitting.

The arguments typically divide into the two cases:

- **SITUATION NO SCC** There are no closed curves of  $Q \cap F$  in the interior of disk faces of  $G_Q$ .
- **SITUATION SCC** There are closed curves of  $Q \cap F$  in the interior of disk faces of  $G_Q$ . The strong irreducibility of the Heegaard splitting allows us then to assume (Section 3.2) that any such closed curve must be nontrivial on  $\widehat{F}$  and bound a disk on one side of  $\widehat{F}$ .

In SITUATION SCC there is then a meridian disk on one side of the genus 2 splitting that is disjoint from  $K$  and  $Q$ . This imposes strong restrictions on the graph  $G_F$ . Typically then, the arguments are simpler (though different) than those for SITUATION NO SCC.

Now assume that  $\hat{F}$  is a Heegaard surface for  $M$  for which  $K$  has the smallest bridge number among genus 2 splittings of  $M$ . The paper is divided into sections ruling out various values of  $t$ , which are necessarily even as  $\hat{F}$  is separating. Theorems 9.1, 10.1 and 11.1 show in sequence  $t < 10, t < 8, t < 6$  in both SITUATION NO SCC and SITUATION SCC. Theorem 13.2 then implies that  $t \leq 2$  in SITUATION NO SCC, and Theorem 18.11 that  $t \leq 2$  in SITUATION SCC. That is,  $K$  is at most 1-bridge with respect to the genus 2 splitting  $\hat{F}$ .

To see that  $K$  (and hence  $K'$ ) has tunnel number at most 2, write  $K$  in  $M$  as the union of an arc in  $\hat{F}$  and a trivial arc in a handlebody  $H$  on one side of  $\hat{F}$  (this can be done if  $K$  is 0-bridge as well). Attaching two tunnels to  $K$  to form core curves of  $H$  thickens to a genus 3 handlebody whose complement is a handlebody in  $M$ . Thus the tunnel number of  $K$  is at most two.  $\square$

Keeping track of when and how we are forced to modify the Heegaard splitting in the proof of Theorem 2.4 gives the following:

**Theorem 2.6** *Let  $K'$  be a hyperbolic knot in  $S^3$ . Let  $H_B \cup_{\hat{F}} H_W$  be a genus 2 (2-sided) Heegaard splitting of  $M = K'(\gamma)$ . Assume that  $\Delta(\gamma, \mu) \geq 3$ , where  $\mu$  is the meridian of  $K'$ . Furthermore assume that  $M$  does not contain a Dyck's surface. Denote by  $K$  the core of the attached solid torus in  $M$ . Then either*

- (1)  $K$  is 0-bridge or 1-bridge with respect to a Heegaard splitting of  $M$  obtained from  $H_B \cup_{\hat{F}} H_W$  by a (possibly empty) sequence of adding/removing Möbius bands (Definition 1.1); or
- (2)  $M$  is a Seifert fiber space over the disk with three exceptional fibers, one of which has order 2 or 3, and  $K$  is 0-bridge or 1-bridge with respect to a Heegaard splitting gotten from a vertical Heegaard splitting of the Seifert fiber space  $M$  which has been changed by a (possibly empty) sequence of adding/removing Möbius bands; or
- (3)  $M$  is  $n/2$ -surgery on a trefoil knot,  $n$  odd, and  $K$  is 0-bridge or 1-bridge with respect to the Heegaard splitting on  $M$  coming from the genus 2 splitting of the trefoil knot exterior. Note that in this case  $M$  is a Seifert fiber space over the 2-sphere with three exceptional fibers, one of order 2 and a second of order 3.

In particular, if  $M$  is not a Seifert fiber space over the 2–sphere with an exceptional fiber of order 2 or 3, and if the Heegaard surface  $\hat{F}$  has no Möbius band on one side whose boundary is a primitive curve on the other, then  $K$  must be 0–bridge or 1–bridge with respect to the given splitting  $H_B \cup_{\hat{F}} H_W$ .

**Proof** Let  $H_B \cup_{\hat{F}} H_W$  be a genus 2 Heegaard splitting of  $M$  for which  $K$  is not 0–bridge or 1–bridge. As in the proof of [Theorem 2.4](#), the arguments of [Sections 8–18](#) show, or can be adapted to show, that either

- $M$  contains a Dyck’s surface; or
- $H_B \cup_{\hat{F}} H_W$  can be altered by adding/removing a Möbius band so that we get a new genus 2 splitting for which  $K$  has smaller bridge number; or
- $M$  is a Seifert fiber space over the 2–sphere with an exceptional fiber of order 2 or 3 and we can find a vertical splitting of this Seifert fiber space for which  $K$  has smaller bridge number; or
- $M$  is an  $n/2$ –surgery on the trefoil knot,  $n$  odd, and  $K$  is shown to be at most 1–bridge with respect to a genus 2 splitting of  $M$  coming from the Heegaard splitting of the trefoil exterior (ie remove a neighborhood of the unknotting tunnel from the exterior of the trefoil for one handlebody of the splitting of  $M$ , then the filling solid torus in union with a neighborhood of the unknotting tunnel is the other). This conclusion only occurs at the very end of [Section 18](#).

In [Sections 8–18](#), there are a few places where the argument given needs to be altered slightly to see that in fact one of the items above occurs. We have included remarks to that end when necessary. Repeated applications of the above alternatives lead to a genus 2 splitting of  $M$  with respect to which  $K$  is 0–bridge or 1–bridge as claimed by [Theorem 2.6](#). Note that the statement there when  $M$  is a Seifert fiber space with an exceptional fiber of order 2 or 3 follows by starting with a vertical splitting of  $M$ .  $\square$

### 2.3 When thin position is not bridge position

We finish this section with the proof of [Theorem 2.4](#) in the special case that thin position is not bridge position. Here the arguments of the preceding proof are applied to thin level surfaces rather than thick.

**Theorem 2.7** *Let  $K'$  be a hyperbolic knot in  $S^3$ . Assume there is a genus two Heegaard splitting of  $M = K'(\gamma)$  with respect to which  $K$ , the core of the attached solid torus, has a thin position which is not a bridge position. If  $\Delta(\gamma, \mu) \geq 3$  then  $M$  contains an embedded Dyck’s surface.*

**Proof** Let  $K', K, M$  be as given. Assume  $M$  has a genus 2 Heegaard splitting with respect to which  $K$  (in  $M$ ) has a thin presentation which is not a bridge presentation. Note that this implies  $K$  is not isotopic onto the Heegaard surface of the splitting. As  $M$  is neither a lens space nor a connected sum, the splitting is irreducible and therefore strongly irreducible. Let  $\hat{F}$  be a thin level surface: a level surface at a regular value of the height function such that the first critical level below the surface is a maximum and the first critical level above the surface is a minimum.

**Lemma 2.8** *Let  $\hat{F}$  be a thin level surface in a thin presentation of  $K$ . There is no trivializing disk  $D$  for a subarc  $\alpha$  of  $K$  with respect to  $\hat{F}$ . That is, there is no embedded disk  $D \subset M$  such that:*

- (1) *The interior of  $D$  is disjoint from  $K$ .*
- (2)  *$\partial D = \alpha \cup \beta$ , where  $\alpha$  is a subarc of  $K$  and  $\beta$  lies in  $\hat{F}$ .*

**Proof** After an isotopy we may assume that  $D$  lies above  $\hat{F}$  near  $\beta$  and otherwise  $D$  intersects  $\hat{F}$  transversely. Among all the arcs of  $\text{Int } D \cap \hat{F}$ , let  $\beta'$  be outermost with respect to  $\beta$ , and let  $D'$  be the outermost disk that it cuts from  $D$ . (If none exists take  $\beta' = \beta$  and  $D' = D$ .) Then  $\partial D' = \alpha' \cup \beta'$ , where  $\alpha'$  is a component of  $K - \hat{F}$ .  $D'$  guides an isotopy of  $\alpha'$  to  $\beta'$ , giving a positioning of  $K$  with smaller width, a contradiction.  $\square$

In  $S^3$ , put  $K'$  into thin position with respect to the genus 0 Heegaard splitting. The thin position argument of [13], shows that there exists a level surface  $\hat{Q}$  of  $S^3$  such that  $F = \hat{F} - N(K)$  and  $Q = \hat{Q} - N(K')$  intersect transversely and each arc of  $F \cap Q$  is essential in  $F$ . Furthermore, Lemma 2.8 shows that each arc of  $F \cap Q$  is essential in  $Q$  ( $\partial F, \partial Q$  are taken to intersect minimally on the boundary of the knot exterior). As the exterior of  $K'$  is irreducible, after an isotopy we may further assume there are no simple closed curves of  $F \cap Q$  that are trivial in both  $F$  and  $Q$ .

We set up the fat vertexed graphs of intersection  $G_Q$  in  $\hat{Q}$  and  $G_F$  in  $\hat{F}$  as in the proof of Theorem 2.4, recording the intersection patterns of  $F$  and  $Q$ . Let  $t = |\hat{F} \cap K| > 0$ .

Exactly as in the context of Theorem 2.4, there are two cases to consider:

- **SITUATION NO SCC** There are no closed curves of  $Q \cap F$  in the interior of disk faces of  $G_Q$ .
- **SITUATION SCC** There are closed curves of  $Q \cap F$  in the interior of disk faces of  $G_Q$ . The strong irreducibility of the Heegaard splitting allows us then to assume (Section 3.2) that any such closed curve must be nontrivial on  $\hat{F}$  and bound a disk on one side of  $\hat{F}$ . In SITUATION SCC, there is then a meridian disk on one side of the genus 2 splitting that is disjoint from  $K$  and  $Q$ .



The following arguments assume familiarity with Sections 3–6 and, in particular, Section 8. The reader is recommended to return here after looking at those sections. The arguments of Sections 3, 4 and 5 apply just as in the context of Theorem 2.4 giving rise to ESCs and SCs, and their corresponding long Möbius bands and Möbius bands. The constituent annuli and Möbius bands of the long Möbius bands are almost properly embedded on either side of  $\hat{F}$ , and they are properly embedded in SITUATION NO SCC.

The arguments beginning with Section 8 assume that the given thin presentation of  $K$  from which  $\hat{F}$  is taken is a bridge presentation of  $K$ . When this is not the case and we use a thin surface  $\hat{F}$ , which will satisfy Lemma 2.8, the arguments of Section 8 simplify and strengthen. In particular we now have the following stronger versions of Lemmas 8.5 and 8.13.

**Lemma 2.9** *Let  $\sigma$  be a proper  $(n - 1)$ -ESC in  $G_Q$ . Let  $A = A_1 \cup \dots \cup A_n$  be the corresponding long Möbius band and let  $a_i \in a(\sigma)$  be  $\partial A_i - \partial A_{i-1}$  for each  $i = 2, \dots, n$  and  $a_1 = \partial A_1$ . Assume that, for some  $i < j$ ,  $a_i, a_j$  cobound an annulus  $B$  in  $\hat{F}$ . Then  $K$  must intersect the interior of  $B$ .*

**Proof** The context of Section 8 is that of Theorem 2.4, that  $K$  is in a bridge position that is also thin. However, the proof of Lemma 8.5 proves the above, using a thin presentation of  $K$ , and inserting Lemmas 2.8 and 2.3 when necessary. In particular, the final conclusion of Lemma 8.5, that  $V$  guides an isotopy of  $A_j$  to  $B$ , contradicts Lemma 2.8. □

**Lemma 2.10** *Assume  $M$  contains no Dyck’s surface. If  $G_Q$  contains a proper  $r$ -ESC then  $r \leq 1$ . Furthermore, if  $\sigma$  is a proper 1-ESC then the two components of  $a(\sigma)$  are not isotopic on  $\hat{F}$ .*

**Proof** Let  $\sigma$  be a proper  $(n - 1)$ -ESC in  $G_Q$  for which  $n$  is largest. We assume  $n \geq 2$ . Let  $A = A_1 \cup A_2 \cup \dots \cup A_n$  be the long Möbius band associated to  $\sigma$ . Let  $a(\sigma)$  be the collection of simple closed curves  $a_i = \partial A_i \cap \partial A_{i+1}$ . If no two elements of  $a(\sigma)$  are isotopic on  $\hat{F}$ , then either  $n = 3$  and  $a_1, a_2, a_3$  cobound a 3-punctured sphere in  $\hat{F}$ , contradicting (Lemma 8.12) that  $M$  contains no Dyck’s surface, or  $n = 2$  and we satisfy the second conclusion. Thus we assume  $a_i, a_j$  are isotopic on  $\hat{F}$  for some  $i < j$ . Let  $B$  be the annulus cobounded by  $a_i, a_j$  on  $\hat{F}$ . We may assume that the interior of  $B$  is disjoint from  $a(\sigma)$ .

Lemma 2.9 shows that there is a vertex  $x$  of  $K \cap \text{Int } B$ . Since, by Corollary 5.4,  $\Lambda_x$  contains a bigon, there is a proper ESC,  $v$ , and a corresponding long Möbius band  $A^x$  whose boundary is a curve comprising two edges of  $\Lambda_x$  meeting at  $x$  and one

other vertex. Therefore this curve cannot transversely intersect  $\partial B$  and thus must be contained in  $B$ . By Lemma 4.3,  $\nu, \sigma$  must have the same core labels. But this contradicts the maximality of  $n$ .  $\square$

Finally, observe:

**Lemma 2.11** *If  $G_Q$  contains a 1-ESC,  $\sigma$ , and an SC,  $\tau$ , on disjoint label sets, then  $M$  contains a Dyck's surface.*

**Proof** Let  $A = A_1 \cup A_2$  be the long Möbius band corresponding to  $\sigma$  and  $A_3$  the almost properly embedded Möbius band corresponding to  $\tau$ . By Lemma 2.10, the components of  $\partial A_2$  are not isotopic on  $\widehat{F}$ . Neither is isotopic to  $\partial A_3$ , else  $M$  would contain a Klein bottle. By Lemma 8.12,  $M$  contains a Dyck's surface.  $\square$

To finish the proof of the theorem, assume  $M$  contains no Dyck's surface. Lemmas 2.12, 2.13, 2.15 and 2.16 now eliminate the possibilities for  $t$ .

**Lemma 2.12**  $t < 8$

**Proof** By Corollary 5.4 and Lemma 2.10, each label of  $G_Q$  belongs to a 1-ESC or to an SC. Assume  $t \geq 8$ . If  $G_Q$  contains no 1-ESC, then there are three SCs on disjoint label sets, and Lemma 8.11 contradicts that  $M$  contains no Dyck's surface.

So assume  $G_Q$  contains a 1-ESC,  $\sigma$ , on labels, say,  $\{1, 2, 3, 4\}$ , ie whose core is a (23)-SC. By Lemma 2.11, the label 7 of  $G_Q$  belongs to a 1-ESC on labels  $\{7, 8, 1, 2\}$ . Similarly, label 6 must belong to a 1-ESC on labels  $\{3, 4, 5, 6\}$ . The latter 1-ESCs contradict Lemma 2.11.  $\square$

**Lemma 2.13**  $t \neq 6$

**Proof**

**Claim 2.14** *With  $t = 6$ ,  $G_Q$  cannot have two 1-ESCs on different label sets whose core SCs lie on the same side of  $\widehat{F}$ .*

**Proof** WLOG assume  $\sigma, \sigma'$  are 1-ESCs on labels  $\{1, 2, 3, 4\}, \{3, 4, 5, 6\}$  (respectively). Let  $A = A_1 \cup A_2, A' = A'_1 \cup A'_2$  be the long Möbius bands corresponding to  $\sigma, \sigma'$ . First assume SITUATION NO SCC. Then  $A_2, A'_2$  are (nonseparating) incompressible annuli in a handlebody on one side of  $\widehat{F}$  intersecting in the single arc (34) of  $K$ . A boundary compressing disk of  $A_2$  can be taken disjoint from  $A'_2$  (or vice versa). This disk can be used to construct a trivializing disk for (34), contradicting Lemma 2.8.

So assume we are in SITUATION SCC and let  $D$  be a meridian disjoint from  $Q$  and  $K$ . As each component of  $\partial A_2$  intersects  $\partial A'_2$  in a single point,  $\partial D$  must be separating in  $\hat{F}$ . In particular, one component of  $\hat{F} - \partial D$  contains vertices  $\{2, 3, 6\}$  of  $G_F$  and the other contains vertices  $\{4, 5, 1\}$ . But the arcs (34), (61) of  $K$  contradict that  $D$  is separating on one side of  $\hat{F}$ .  $\square$

Assume  $t = 6$ . By Corollary 5.4 and Lemma 2.10, each of the six labels of  $G_Q$  belong to either a 1-ESC or SC in  $G_Q$ . If  $G_Q$  contains no 1-ESC, then  $G_Q$  must have three SCs on disjoint label sets. Lemma 8.11 shows that  $M$  contains a Dyck's surface. So assume  $G_Q$  contains a 1-ESC on labels, say,  $\{1, 2, 3, 4\}$ .

If  $G_Q$  also contains a 1-ESC on a different label set, then by Claim 2.14 and Lemma 2.11, we may assume it is on labels  $\{2, 3, 4, 5\}$ . Now label 6 must belong to a 1-ESC or an SC. A 1-ESC contradicts Claim 2.14, an SC contradicts Lemma 2.11.

So we assume all 1-ESCs are on label set  $\{1, 2, 3, 4\}$ . Corollary 5.4 then implies there is a (45)-SC and a (61)-SC (a (56)-SC contradicts Lemma 2.11). But then Lemma 8.11 says that  $M$  contains a Dyck's surface.  $\square$

**Lemma 2.15**  $t \neq 4$

**Proof** Let  $t = 4$ . By Corollary 5.4,  $G_Q$  either contains a 1-ESC or two SCs on disjoint label sets. First assume we have SITUATION NO SCC. In the case of a 1-ESC a boundary compression of the associated incompressible annulus and in the case of two SCs a boundary compression of one Möbius band disjoint from the second, gives rise to a trivializing disk for an arc of  $K - \hat{F}$ , contradicting Lemma 2.8.

So assume we are in SITUATION SCC, and let  $D$  be a meridian on one side of  $\hat{F}$  disjoint from  $Q$  and  $K$ . Let  $\mathcal{N}$  be the solid torus or tori obtained by surgering the handlebody in which  $D$  lies along  $D$ , and that have nonempty intersection with  $K$ .

Assume  $G_Q$  has a 1-ESC, and let  $A = A_1 \cup A_2$  be the associated long Möbius band. After an isotopy we may take  $A_1, A_2$  as properly embedded in  $\mathcal{N}$  or its exterior. If  $A_2$  lies in  $\mathcal{N}$ , then a boundary compression of  $A_2$  in  $\mathcal{N}$  gives a trivializing disk for an arc of  $K - \hat{F}$ . Thus  $A_2$  lies outside of  $\mathcal{N}$ . If both components of  $\partial A_2$  lie on the same component of  $\mathcal{N}$ , then  $\mathcal{O} = N(\mathcal{N} \cup A_2)$  is Seifert fibered over the annulus with an exceptional fiber of order two. As the exterior of  $K$  is atoroidal and irreducible, some component of  $M - \text{Int } \mathcal{O}$  bounds a solid torus  $\mathcal{T}$ . As  $M$  is irreducible and atoroidal and as  $M$  is not a Seifert fiber space (Lemma 2.3),  $\mathcal{O} \cup \mathcal{T}$  is a solid torus whose exterior in  $M$  has incompressible boundary. Again as the exterior of  $K$  is atoroidal and irreducible,  $K$  must be isotopic to a core of the solid torus  $\mathcal{O} \cup \mathcal{T}$  and consequently to the core of

$\mathcal{N}$ . But then  $K$  can be isotoped to lie on the Heegaard surface; a contradiction. So we may assume  $\mathcal{N}$  consists of two solid tori, each containing a component of  $\partial A_2$ . But then a boundary compression of  $A_1$  in the solid torus component containing it, gives rise to a trivializing disk for an arc of  $K - \hat{F}$ .

So it must be that  $G_Q$  contains SCs on disjoint labels sets. Let  $A, A'$  be the corresponding almost properly embedded Möbius bands. As  $M$  contains no Klein bottle or projective plane,  $\partial A, \partial A'$  must lie on different components of  $\mathcal{N}$ . Then  $D$  is a separating meridian of one side of  $\hat{F}$  and must lie on the same side as the  $A, A'$  (by the separation of vertices of  $G_F$ ). After surgering away simple closed curves of intersection,  $A$  and  $A'$  can be taken to be properly embedded Möbius bands in separate components of  $\mathcal{N}$ . Then a boundary compression of either gives rise to a trivializing disk for an arc of  $K - \hat{F}$ . □

**Lemma 2.16**  $t \neq 2$

**Proof** By Corollary 5.4,  $G_Q$  contains an SC. Let  $A$  be the corresponding almost properly embedded Möbius band. In SITUATION NO SCC,  $A$  is properly embedded on one side of  $\hat{F}$ . A boundary compression of  $A$  then gives rise to a trivializing disk for an arc of  $K - \hat{F}$ , contradicting Lemma 2.8. So we assume SITUATION SCC, and let  $D$  be a meridian disjoint from  $Q$  and  $K$ . Let  $\mathcal{N}$  be the solid torus obtained by surgering the handlebody in which  $D$  lies along  $D$  and taking that component containing  $\partial A$ . We may surger the interior of  $A$  off of  $\partial \mathcal{N}$ , so that  $A$  is properly embedded in  $\mathcal{N}$  or its exterior. If  $A$  now lies in  $\mathcal{N}$ , then a boundary compression of it will give rise to a trivializing disk for an arc of  $K - \hat{F}$ . So we assume  $A$  is properly embedded in the exterior of  $\mathcal{N}$  and set  $\mathcal{O} = N(\mathcal{N} \cup A)$ . If  $\partial A$  is longitudinal in  $\mathcal{N}$ , then  $\mathcal{O}$  is a solid torus containing  $K$ . As  $M$  is not a lens space and the exterior of  $K$  is atoroidal and irreducible,  $K$  must be isotopic to a core of  $\mathcal{O}$ . On the other hand, the core  $L$  of  $\mathcal{N}$  is a  $(2, 1)$ -cable of the core of  $\mathcal{O}$ , and hence of  $K$ . As  $L$  has tunnel number one in  $M$ , Claim 8.7 implies that  $K$  can be isotoped to lie on the Heegaard surface.

Thus we assume  $\partial A$  is not longitudinal in  $\mathcal{N}$ . Then  $\mathcal{N}$  is a Seifert fiber space over the disk with two exceptional fibers ( $M$  contains no projective planes). As both  $M$  and the exterior of  $K$  are irreducible and atoroidal, the exterior of  $\mathcal{O}$  is a solid torus, and  $M$  is a Seifert fiber space. This contradicts Lemma 2.3. □

This completes the proof of Theorem 2.7. □

### 3 More on $G_Q$ , $G_F$ and simple closed curves of $F \cap Q$

Assume  $K'$  is a hyperbolic knot in  $S^3$  and  $K'(\gamma)$  has a 2-sided genus 2 Heegaard splitting. Let  $\hat{F}$ ,  $F$ ,  $\hat{Q}$ ,  $Q$  be as in the proof of [Theorem 2.4](#). Let  $G_Q, G_F$  be the labeled graphs of intersection defined there. In this section we define some terminology for  $G_Q, G_F$ , and discuss simple closed curves of intersection between  $Q$  and  $F$ .

#### 3.1 The Parity Rule, Black and White, labels and corners, parallelisms

On each of  $G_Q$  and  $G_F$ , if the labels around two vertices occur in the same direction (equivalently: the oriented intersections of  $K'$  with  $\hat{Q}$  or  $K$  with  $\hat{F}$  at those spots have the same signs) then we say the vertices are *parallel*; otherwise they are *antiparallel*. The orientability of  $F$  and  $Q$  and the knot exterior gives the following:

**Parity Rule** *An edge connects parallel vertices on one of  $G_F, G_Q$  if and only if it connects antiparallel vertices on the other.*

We may refer to an edge of  $G_F$  or  $G_Q$  with endpoints labeled 1 and 2, for example, as a  $\overline{12}$ -edge. We will also say that  $\{1, 2\}$  is the *label pair* of the edge.

In  $M$ , the Heegaard surface  $\hat{F}$  bounds two genus 2 handlebodies  $H_B$  and  $H_W$ :  $M = H_B \cup_{\hat{F}} H_W$ . We refer to  $H_B$  as *Black* and  $H_W$  as *White* and similarly color the objects inside them.

A *face* of  $G_Q$  is a component of the complement of the edges of  $G_Q$  in  $Q$ . We color it Black or White according to the side of  $\hat{F}$  on which a small collar neighborhood of its boundary lies. The arcs of intersection between the boundary of a face and a vertex are the *corners* of the face; a vertex is chopped into corners. We shall refer to both the corners of  $G_Q$  between labels 2 and 3 and the arc of  $K \subset M$  from intersection 2 to 3, for example, as (23), as a (23)-corner, or as a (23)-arc. For a contiguous run of corners  $(t1),(12),(23)$  around a vertex or arcs of  $K$  we may write  $(t123)$ . An *interval* of labels is either a single label or the set of labels appearing in a corner or a contiguous run of corners. For example the interval  $(t3)$  is the run of corners with labels  $\{t, 1, 2, 3\}$ . Analogously, in discussing a subgraph of  $G_Q$ , we talk about the corners of the faces of that subgraph.

Two edges of  $F \cap Q$  are *parallel* on  $F$  or on  $Q$  if they cobound an embedded bigon in that surface (with corners on the vertices). We also refer to such edges as parallel on  $G_F$  or  $G_Q$ . Two faces  $g$  and  $g'$  of  $G_Q$  are *parallel* if there is an embedding of  $g \times [0, 1]$  into  $M - N(K)$  such that  $g \times \{0\} = g$ ,  $g \times \{1\} = g'$  and the components of  $\partial g \times [0, 1]$  are alternately composed of rectangles on  $\partial N(K)$  and parallelisms on  $F$  between edges of  $g$  and  $g'$ .

### 3.2 Simple closed curves of $Q \cap F$

The intersection graphs  $G_Q, G_F$  are given by the arc components of  $F \cap Q$ . However, there may also be simple closed curves in  $Q \cap F$ . By (\*\*) of the proof of [Theorem 2.4](#), we may assume no such curve is trivial on both  $Q$  and  $F$ . We show in this subsection that any such that is trivial on  $Q$  must, WLOG, be a meridian on one side of  $\widehat{F}$ .

**Lemma 3.1** *No simple closed curve of  $Q \cap F$  that is trivial in  $Q$  is trivial in  $\widehat{F}$ .*

**Proof** Otherwise let  $\widehat{D} \subset \widehat{F}$  be the disk bounded by such a simple closed curve. Let  $G_D$  be  $G_F$  restricted to  $\widehat{D}$ . By (\*\*),  $G_D$  is nonempty. Then there are no 1-sided faces in  $G_D$ , and no 1-sided faces in the subgraph of  $G_Q$  corresponding to the edges of  $G_D$ . The argument of [[9](#), Proposition 2.5.6], along with the assumption that  $\Delta \geq 3$ , implies that one of  $G_D$  or  $G_Q$  contains a Scharlemann cycle. Such a Scharlemann cycle would imply the contradiction that either  $S^3$  or  $M$  contains a lens space summand.  $\square$

**Corollary 3.2** *Any simple closed curve of  $F \cap Q$  that is trivial on  $Q$  is a meridian of either  $H_W$  or  $H_B$ .*

**Proof** This follows immediately from [Lemma 3.1](#), [Lemma 3.3](#) below, and the fact that  $H_W \cup_{\widehat{F}} H_B$  is a genus 2, strongly irreducible Heegaard splitting of  $M$ .  $\square$

For [Corollary 3.2](#), we need the following which generalizes [[33](#), Proposition 1.5 and Lemma 2.2].

**Lemma 3.3** *Let  $M = H_W \cup_{\widehat{F}} H_B$  be a Heegaard splitting, where  $M$  is a closed 3-manifold other than  $S^3$ . Let  $C$  be a simple closed curve in  $\widehat{F}$  such that*

- (1)  $C$  does not bound a disk in  $H_W$  or  $H_B$ , and
- (2)  $C$  lies in a 3-ball in  $M$ .

*Then the splitting  $H_W \cup_{\widehat{F}} H_B$  is weakly reducible.*

**Remark 3.4** By the uniqueness of Heegaard splittings of  $S^3$ , [Lemma 3.3](#) also holds when  $M$  is  $S^3$ , provided  $g(\widehat{F}) \neq 1$ .

**Proof** Since  $M$  is not  $S^3$ , the boundary of the 3-ball containing  $C$  is essential in  $M - C$ , so  $M - C$  is reducible. Since  $M - C = H_W \cup_{\widehat{F}-C} H_B$ , and  $H_W$  and  $H_B$  are irreducible, this implies that  $\widehat{F} - C$  is compressible in  $H_W$  or  $H_B$ , say  $H_W$ .

Let  $\mathcal{D}$  be a maximal (with respect to inclusion) disjoint union of properly embedded disks in  $H_W$  such that  $\partial\mathcal{D} \subset \hat{F} - C$ , no component of  $\partial\mathcal{D}$  bounds a disk in  $\hat{F} - C$ , and no pair of components of  $\partial\mathcal{D}$  cobound an annulus in  $\hat{F} - C$ . Note that  $\mathcal{D} \neq \emptyset$ .

There is a collar  $\hat{F} \times I$  of  $\hat{F} = \hat{F} \times \{0\}$  in  $H_W$  and a regular neighborhood  $N(\mathcal{D})$  of  $\mathcal{D}$  in  $H_W$  such that

$$N(\mathcal{D}) \cap C = \emptyset,$$

$$N(\mathcal{D}) \cap (\hat{F} \times I) = (N(\mathcal{D}) \cap \hat{F}) \times I.$$

Let  $H_{W_0}$  be the compression body  $(\hat{F} \times I) \cup N(\mathcal{D})$  with any 2-sphere boundary components capped off with 3-balls in  $H_W$ . Let  $\partial_- H_{W_0} = \partial H_{W_0} - \hat{F}$ . Since  $C$  does not bound a disk in  $H_W$  by hypothesis,  $C \times \{1\}$  is not contained in any 2-sphere component of  $\partial_- H_{W_0}$ . By the maximality of  $\mathcal{D}$ , it follows that  $\partial_- H_{W_0}$  has exactly one component,  $G$ , say, and  $C \times \{1\}$  is contained in  $G$ .

Let  $H_{W_1} \subset H_W$  be the handlebody bounded by  $G$ , and isotope  $C$  into  $\text{Int } H_{W_1}$ . By the maximality of  $\mathcal{D}$ ,  $G$  is incompressible in  $H_{W_1} - C$ . This, together with the irreducibility of  $H_{W_1}$ , implies also that  $H_{W_1} - C$  is irreducible. Let  $M_0 = H_B \cup H_{W_0}$ . Since  $M - C \cong M_0 \cup_G (H_{W_1} - C)$  is reducible, either  $M_0$  is reducible or  $G$  is compressible in  $M_0$ . This implies that the splitting of  $M_0$  given by  $H_{W_0} \cup_{\hat{F}} H_B$  is reducible or weakly reducible, by [23] or [7], respectively. Hence the same holds for  $H_W \cup_{\hat{F}} H_B$ . □

Many of the arguments in later sections naturally divide themselves into the two basic cases:

- **SITUATION NO SCC** There are no closed curves of  $Q \cap F$  in the interior of disk faces of  $G_Q$ . In the later sections, this assumption will allow us to think of the faces of  $G_Q$  as disks in a Heegaard handlebody of  $M$ .
- **SITUATION SCC** There are closed curves of  $Q \cap F$  in the interior of disk faces of  $G_Q$ . By Corollary 3.2, any such curve must be nontrivial on  $\hat{F}$  and bound a disk on one side of  $\hat{F}$ . A disk face of  $G_Q$  containing such a curve does not sit in one Heegaard handlebody of  $M$ , hence some of the arguments applied in SITUATION NO SCC will not apply. However, an innermost such curve will supply a meridian disk  $D$  of either  $H_W$  or  $H_B$  which is disjoint from both  $K$  and  $Q$ . This places strong restrictions on  $G_F$  and yet the combinatorics of the faces of  $G_Q$  remain the same. Also, one can usually think of the faces of  $G_Q$  then as living in the exterior of  $\hat{F}$  surgered along  $D$ . Together, these facts allow simpler, though somewhat different arguments in SITUATION SCC.



## 4 Scharlemann cycles, (forked) extended Scharlemann cycles and long Möbius bands

### 4.1 SC, ESC, FESC

A *Scharlemann cycle* (of length  $n$ ) is a disk face of  $G_Q$  or  $G_F$  with  $n$  edges, all with the same labels  $\{a, b\}$ , and all connecting parallel vertices of the graph. We use the same term for the set of edges defining the face. Typically, the Scharlemann cycles considered in this paper are on  $G_Q$  and of length 2, so we designate such by the abbreviation SC. For specificity, an  $(ab)$ -SC is one whose edges have labels  $\{a, b\}$ . A  $(23)$ -SC whose corners are on the vertices  $x$  and  $y$  is depicted in Figure 1(a). Though it is a rectangle, by virtue of alternatively naming its sides “corners” and “edges”, we call it a *bigon*. A *Scharlemann cycle of length 3* is shown in Figure 1(b). Its face is a *trigon*.

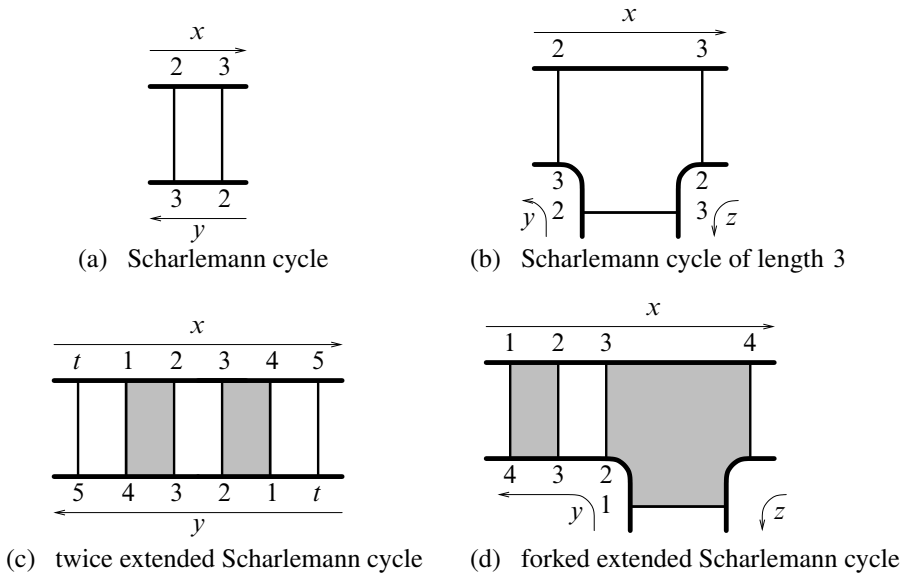

Figure 1

For  $n \geq 0$ , an  $n$ -times extended Scharlemann cycle of length 2, abbreviated  $n$ -ESC, is a set of  $2(n + 1)$  adjacent parallel edges and the  $2n + 1$  bigon faces they delineate between two parallel vertices of a fat vertexed graph such that the central bigon is a Scharlemann cycle of length 2. This central bigon is referred to as the *core Scharlemann cycle* for the  $n$ -ESC. When  $n > 0$ , we sometimes refer to an  $n$ -ESC as simply an “extended Scharlemann cycle”, abbreviated as “ESC”. Figure 1(c) shows a 2-ESC on

the corner  $(t12345)$ . An  $n$ -ESC is called *proper* if in its corner no label appears more than once. As with SCs, to emphasize the labels along the corner of an ESC, we will also call an ESC on the corner  $(t123)$ , for example, an  $(t123)$ -ESC.

A *forked  $n$ -times extended Scharlemann cycle* is an  $(n - 1)$ -times extended Scharlemann cycle of length 2 with an extra bigon and trigon at its two ends. Figure 1(d) shows a forked 1-time extended Scharlemann cycle. In this paper, a “forked extended Scharlemann cycle,” which is abbreviated “FESC,” means a forked 1-time extended Scharlemann cycle.

We will often use the letters  $\sigma$  and  $\tau$  to refer to the sets of edges of these various sorts of SCs and the letters  $f$ ,  $g$  and  $h$  to refer to the faces within them.

### 4.2 Almost properly embedded surfaces, long Möbius bands

**Definition 4.1** Let  $H$  be a handlebody on one side of  $\hat{F}$ . A surface,  $A$ , in  $M$  is *almost properly embedded in  $H$*  if

- (1)  $\partial A \subset \hat{F}$  and  $A$  near  $\partial A$  lies in  $H$ ;
- (2)  $\text{Int } A$  is transverse to  $\hat{F}$  and  $A \cap \hat{F}$  consists of  $\partial A$  along with a collection of simple closed curves, referred to as  $\partial_I A$ . Each component of  $\partial_I A$  is trivial in  $A$ , essential in  $\hat{F}$  and bounds a disk on one side of  $\hat{F}$  (ie is a meridian for  $H_W$  or  $H_B$ ).

We use the disk faces of  $G_Q$  to build almost properly embedded surfaces in  $H_W, H_B$ .

Assume (23) is a White arc of  $K \cap H_W \subset M$ . By  $N((23))$  we indicate the closed 1-handle neighborhood  $I \times D^2$  of  $(23) \subset H_W$  that is a component of  $H_W - \text{Int}(M - N(K))$ .

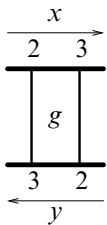

(a) Scharleman cycle

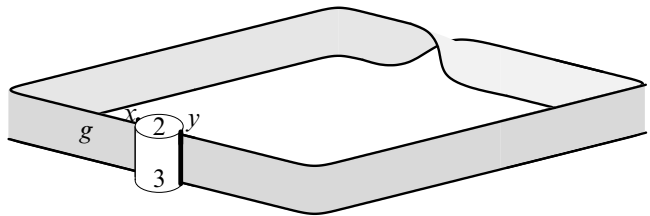

(b) Möbius band

Figure 2

Let  $g$  be the bigon face of a  $(23)$ -SC of  $G_Q$  shown in Figure 2(a). Then in  $M$  the two corners of  $g$  both run along the 1-handle  $N((23)) \subset H_W$  extending radially to the

(23)–arc of  $K$ . This forms a White Möbius band  $A_{23} = g \cup (23)$ . Refer to Figure 2(b). If  $\text{Int } g$  is disjoint from  $\widehat{F}$ , then  $A_{23}$  is properly embedded in  $H_W$ ; otherwise, by Corollary 3.2, it is almost properly embedded in  $H_W$ .

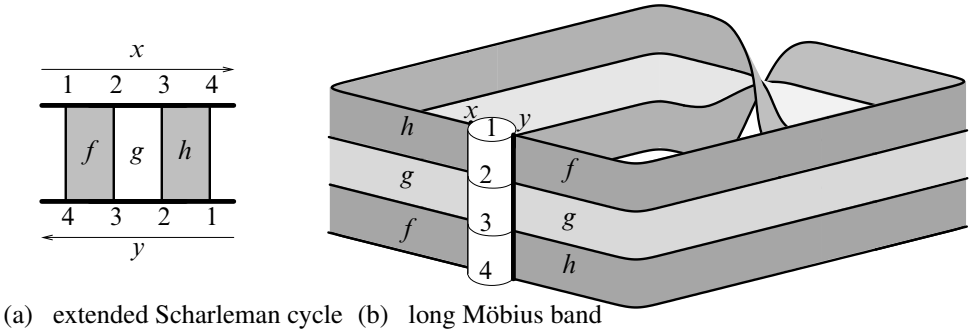

Figure 3

Assume the two Black (12),(34)–bigons  $f$  and  $h$  flank  $g$  as in Figure 3(a). Identifying their corners to the arcs (12) and (34) of  $K$  accordingly in  $M$  forms a Black annulus  $A_{12,34} = f \cup (12) \cup h \cup (34)$ , which by Corollary 3.2 is almost properly embedded in  $H_B$ . As  $\partial A_{23}$  is a component of  $\partial A_{12,34}$ , together  $A_{23} \cup A_{12,34}$  is a Möbius band. We regard it as a *long Möbius band*, where the annulus  $A_{12,34}$  extends the Möbius band  $A_{23}$ . See Figure 3(b). Note that the arc (1234) is a spanning arc of the long Möbius band.

More generally, given  $\sigma$ , an  $(n - 1)$ –times ESC ( $n \geq 2$ ), we may again form a long Möbius band  $A_1 \cup A_2 \cup \dots \cup A_n$ , where  $A_1$  is an almost properly embedded Möbius band arising from the core Scharlemann cycle and each  $A_i$ ,  $i \geq 2$ , is an (almost properly embedded) extending annulus formed from successive pairs of flanking bigons. The  $A_i$  with odd indices  $i$  will have one color and those with even indices will have the other color. Let  $a_i$  denote the boundary component  $\partial A_i \cap \partial A_{i+1}$ . Let  $a(\sigma) = \{a_i \mid i = 1, \dots, n - 1\}$ . Denote by  $L(\sigma)$ , the label set for  $\sigma$ , the set of labels appearing on a corner of  $\sigma$ . The *core labels* for  $\sigma$  are the two labels of its core Scharlemann cycle. For example, if  $\sigma$  is as in Figure 3(a),  $L(\sigma) = \{1, 2, 3, 4\}$  and the core labels of  $\sigma$  are  $\{2, 3\}$ .

Generically we will use this notation,  $A_1 \cup A_2 \cup \dots \cup A_n$ , for a long Möbius band and its constituent annuli and Möbius band, but when  $n \leq 3$  we will often use the notation  $A_{23}, A_{12,34}, \dots$  described above to emphasize the arc of  $K$  on the long Möbius band or its constituent annuli.

The consideration of long Möbius bands falls into two basic contexts (see [Section 4.2](#)):

- **SITUATION NO SCC** There are no closed curves of  $Q \cap F$  in the interior of disk faces of  $G_Q$ . Thus the annuli, Möbius band constituents of a long Möbius band are each properly embedded in  $H_W$  or  $H_B$ .
- **SITUATION SCC** There are closed curves of  $Q \cap F$  in the interior of disk faces of  $G_Q$ . By [Corollary 3.2](#), any such curve must be nontrivial on  $\hat{F}$  and bound a disk on one side of  $\hat{F}$ . In this case the annuli, Möbius band constituents of a long Möbius band are each almost properly embedded on one side of  $\hat{F}$ . Furthermore, there is a meridian disk  $D$  of either  $H_W$  or  $H_B$  which is disjoint from both  $K$  and  $Q$ .

The fact that in SITUATION SCC, the constituent annuli of the long Möbius bands are almost properly embedded rather than properly embedded, complicates the picture of these surfaces. On the other hand, the existence of the meridian disk  $D$  in this case (disjoint from  $Q$ ), greatly restricts what  $Q$  can look like and usually simplifies the arguments considerably.

We finish this subsection by describing some properties of long Möbius bands.

**Lemma 4.2** *Let  $\sigma$  be an  $n$ -ESC,  $n \geq 0$ . Then no component of  $a(\sigma)$  bounds a disk on either side of  $\hat{F}$ .*

**Proof** Otherwise, the long Möbius band corresponding to  $\sigma$  coupled with the meridian disk bounded by the component of  $a(\sigma)$  can be used to create an embedded projective plane in  $M$ . Since  $M$  is  $K'(\gamma)$ , where  $\Delta \geq 3$ , this contradicts either [\[18\]](#) or [\[9\]](#).  $\square$

**Lemma 4.3** *Let  $\sigma$  be a proper  $n_1$ -ESC and  $\tau$  a proper  $n_2$ -ESC of  $G_Q$ . If there are components  $a_\sigma, a_\tau$  of  $a(\sigma), a(\tau)$  (respectively) that are isotopic on  $\hat{F}$ , then  $\sigma, \tau$  have the same core labels.*

*Addendum: Let  $D$  be a meridian disk of  $H_B, H_W$  disjoint from  $K$  and  $Q$ . Let  $F^*$  be  $\hat{F}$  surgered along  $D$ . If components  $a_\sigma, a_\tau$  of  $a(\sigma), a(\tau)$  (respectively) are isotopic on  $F^*$ , then  $\sigma, \tau$  have the same core labels.*

**Proof** The argument for the Addendum is the same as that for the Lemma with  $F^*$  replacing  $\hat{F}$ , so we give only the argument for the Lemma itself.

For the proof of this Lemma, we use ESC to refer to an  $n$ -ESC for which  $n \geq 0$ . Let  $A(\sigma), A(\tau)$  be the long Möbius bands corresponding to  $\sigma, \tau$ . By possibly working with ESCs within  $\sigma, \tau$ , we may assume  $a_\sigma = \partial A(\sigma)$  and  $a_\tau = \partial A(\tau)$ . We write

$A(\sigma) = E_\sigma \cup F_\sigma, A(\tau) = E_\tau \cup F_\tau$ , where  $F_\sigma, F_\tau$  is the union of faces of  $\sigma, \tau$  (respectively) (thought of as disks in  $X_K$ , the exterior of  $K$ ) and where  $E_\sigma, E_\tau$  are rectangles in  $N(K)$  describing an extension of  $F_\sigma, F_\tau$  across  $N(K)$  to form the long Möbius band. Thus,  $\partial E_\sigma \cap \partial X_K = \partial F_\sigma \cap \partial X_K$  and  $\partial E_\tau \cap \partial X_K = \partial F_\tau \cap \partial X_K$ . In all but Case IV' below (and Case II when  $\sigma, \tau$  have the same core labels), we will choose  $E_\sigma, E_\tau$  to be disjoint, making  $A(\sigma), A(\tau)$  disjoint long Möbius bands whose boundaries are isotopic on  $\hat{F}$ . Such long Möbius bands can be used to construct an embedded projective plane or Klein bottle in  $M$  (note that each component of  $A(\sigma) \cap \hat{F}$  is either a component of  $a(\sigma)$  or a meridian of  $H_W, H_B$ ; the same for  $A(\tau)$ ). This contradicts either [9], [18] or [20]. Thus in each case below, it suffices to show how to construct the desired  $E_\sigma, E_\tau$ .

Let  $\{\alpha, \beta\}$  be the corners of  $\sigma$ ,  $\{\alpha', \beta'\}$  the corners of  $\tau$  (thought of as arcs in  $\partial X_K$ ). Let  $\{x, z\}$  be the labels at the endpoints of the corners of  $\sigma$ , and  $\{y, w\}$  the labels at the endpoints of the corners of  $\tau$ . See Figure 4.

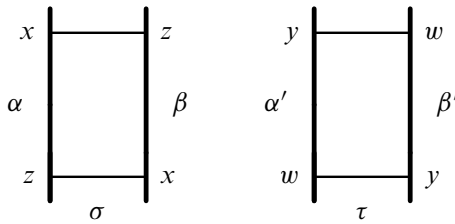

Figure 4

Let  $L(\sigma), L(\tau)$  denote the label set of  $\sigma, \tau$ .

**Case I**  $L(\sigma) \cap L(\tau) = \emptyset$

In this case  $E_\sigma, E_\tau$  are automatically disjoint, and  $A(\sigma), A(\tau)$  can be used to construct the forbidden projective plane or Klein bottle.

**Case II**  $L(\tau) \subset L(\sigma)$

We may assume that, say,  $y \neq x, z$ . Let  $b_\sigma$  be the component of  $a(\sigma)$  through vertex  $y$ , connecting  $y$  to another vertex  $r$ . If  $r = w$ , then  $\sigma, \tau$  have the same core labels and we are done.

Thus we assume  $r \neq y, w, x, z$  ( $r \neq y$  by the Parity Rule). Then  $b_\sigma$  intersects  $a_\tau$  in a single point (at the vertex  $y$ ). Since  $b_\sigma$  is disjoint from  $a_\sigma$ , and  $a_\sigma$  is isotopic to  $a_\tau$

on  $\widehat{F}$ ,  $b_\sigma$  must intersect  $a_\tau$  tangentially. That is, as one transverses around (fat) vertex  $y$  of  $G_F$  the labels  $\{\alpha, \beta\}$  are not separated by the labels  $\{\alpha', \beta'\}$ . Thus in  $N(K)$ , we may choose disjoint  $E_\sigma, E_\tau$  as pictured in Figure 5 (thereby making  $A(\sigma), A(\tau)$  disjoint).

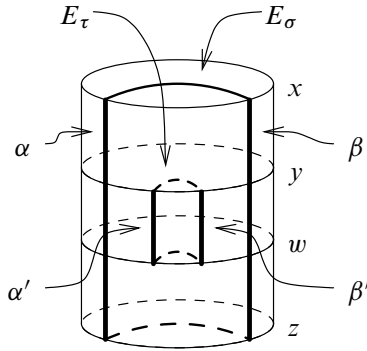

Figure 5

**Case III**  $L(\sigma) \cap L(\tau)$  is a single interval of labels  $(xy)$  (including a point interval).

First we consider the case of a point interval, that is, when  $x = y$  (and Case II does not hold). Then  $a_\sigma, a_\tau$  intersect in a single point (at vertex  $x = y$ ). As  $a_\sigma, a_\tau$  are isotopic on  $\widehat{F}$ , they must be nontransverse around vertex  $x$  on  $G_F$ . This means that as one reads around vertex  $x$  on  $G_F$ , labels  $\{\alpha, \beta\}$  do not separate the labels  $\{\alpha', \beta'\}$ . We choose disjoint  $E_\sigma, E_\tau$  as pictured in Figure 6 (with  $x = y$ ), making  $A(\sigma), A(\tau)$  disjoint.

Thus we may assume that  $\{x, z\} \cap \{y, w\} = \emptyset$ . Let  $b_\sigma$  be the component of  $a(\sigma)$  through vertex  $y$ . Then  $b_\sigma$  intersects  $a_\tau$  in a single point (at  $y$ ). Again  $b_\sigma$  is disjoint from  $a_\sigma$  which is isotopic to  $a_\tau$ , so  $b_\sigma$  must intersect  $a_\tau$  tangentially. Thus, as one transverses vertex  $y$  in  $G_F$  the  $\{\alpha, \beta\}$  labels do not separate  $\{\alpha', \beta'\}$ . We then may choose disjoint  $E_\sigma, E_\tau$  as pictured in Figure 6.

**Case IV**  $L(\sigma) \cap L(\tau)$  contains all labels of  $G_Q$ , and  $L(\sigma)$  overlaps  $L(\tau)$  in two intervals of labels:  $(xy)$  and  $(wz)$ . See Figure 7.

If  $\{x, z\} = \{y, w\}$  then  $\partial A(\sigma), \partial A(\tau)$  are isotopic on  $\widehat{F}$  and both go through vertices  $x, z$  of  $\widehat{F}$ . Thus  $A(\sigma), A(\tau)$  can be amalgamated along their boundary to create an embedded Klein bottle.

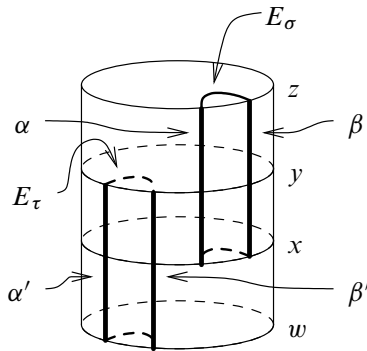

Figure 6

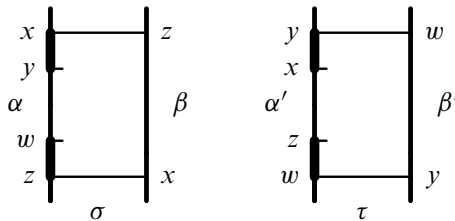

Figure 7

Next assume that  $x = y$  but  $z \neq w$ . Let  $b_\sigma$  be the component of  $a(\sigma)$  through vertex  $w$ . As  $b_\sigma$  is disjoint from  $a_\sigma$  and intersects  $a_\tau$  once at  $w$ ,  $b_\sigma$  and  $a_\tau$  intersect nontransversely. Thus around vertex  $w$ , the labels  $\{\alpha, \beta\}$  do not separate  $\{\alpha', \beta'\}$ . Similarly, as  $a_\sigma, a_\tau$  intersect in a single point at vertex  $x$  and yet are isotopic, their intersection is nontransverse. That is, around vertex  $x$ , the labels  $\{\alpha, \beta\}$  do not separate  $\{\alpha', \beta'\}$ . Figure 8 (with  $x = y$ ) shows that we can choose disjoint  $E_\sigma, E_\tau$ .

Thus we may assume  $\{x, z\} \cap \{y, w\} = \emptyset$ . Let  $b_\sigma$  be the component of  $a(\sigma)$  through vertex  $y$ , and let  $r$  be the other vertex of  $G_F$  to which  $b_\sigma$  is incident. Then  $r \neq x, z$ .

Assume  $r \neq w$ . Then as  $b_\sigma$  intersects  $a_\tau$  once and is disjoint from  $a_\sigma$ , it must intersect  $a_\tau$  nontransversely. That is, around vertex  $y$  the labels  $\{\alpha, \beta\}$  do not separate  $\{\alpha', \beta'\}$ . Let  $c_\sigma$  be the component of  $a(\sigma)$  through vertex  $w$ . Again,  $c_\sigma$  must intersect  $a_\tau$  nontransversely at  $w$ . Hence around  $w$  in  $G_F$ , the labels  $\{\alpha, \beta\}$  do not separate  $\{\alpha', \beta'\}$ . Thus we may choose disjoint disks  $E_\sigma, E_\tau$  in  $N(K)$  as pictured in Figure 8.

This leaves us with the case that  $r = w$ , whose argument is slightly different from the preceding ones.

**Case IV'** In Case IV above,  $r = w$ .



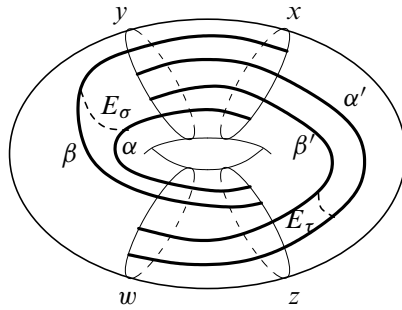

Figure 8

This is the case when the core labels of  $\sigma, \tau$  are “antipodal” labels. Let  $b_\sigma$  be the component of  $a(\sigma)$  through vertices  $y$  and  $w$  of  $G_F$ . Then  $b_\sigma$  and  $a_\tau$  intersect twice. Since  $b_\sigma$  is disjoint from  $a_\sigma$  which is isotopic to  $a_\tau$ , the algebraic intersection number of  $b_\sigma$  and  $a_\tau$  is 0. Thus we can choose  $E_\sigma, E_\tau$  in  $N(K)$  so that they are either (1) disjoint or (2) intersect in exactly two arcs. See Figure 9. This follows since the labels  $\{\alpha, \beta\}$  must separate  $\{\alpha', \beta'\}$  either (1) around neither vertices  $y, w$  or (2) around both vertices  $y, w$ .

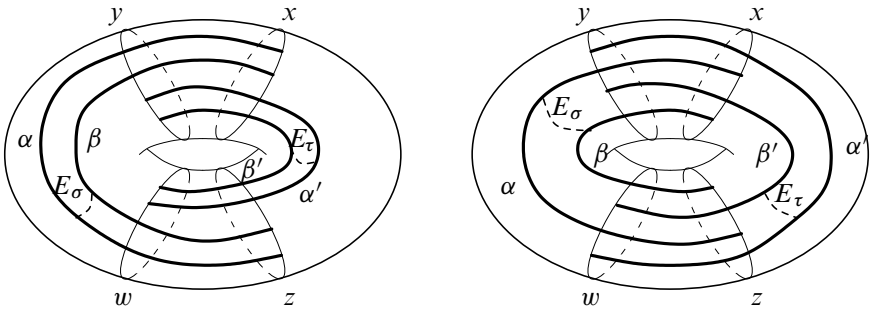

Figure 9

Let  $B$  be the annulus on  $\hat{F}$  between  $a_\sigma$  and  $a_\tau$ . If  $\text{Int } B$  contains a vertex  $u$  of  $G_F$  (ie a vertex other than  $x, y, w, z$ ), then there must be another,  $v$ , such that  $u, v$  lie on the same component of  $a(\sigma)$  or  $a(\tau)$ . If only one, say  $a(\sigma)$ , then we let  $\sigma'$  be the ESC within  $\sigma$  on labels  $u, v$ . Then we may apply the argument of Case I to  $\sigma', \tau$ . If  $u, v$  lie on components of both  $a(\sigma)$  and  $a(\tau)$ , then we let  $\sigma', \tau'$  be the ESC within  $\sigma, \tau$  (respectively) with labels  $\{u, v\}$ . We apply the argument at the beginning of Case IV (when  $\{x, z\} = \{y, w\}$ ).

Thus we may assume  $\text{Int } B$  is disjoint from the vertices of  $G_F$ . Consider  $A(\sigma) = E_\sigma \cup F_\sigma, A(\tau) = E_\tau \cup F_\tau$ , where  $F_\sigma, F_\tau$  is the union of faces of  $\sigma, \tau$ . Then  $A(\sigma), A(\tau)$

are either (1) disjoint or (2) intersect in two double arcs (from  $x$  to  $y$  and  $w$  to  $z$  along  $K$ ). If (1),  $M$  contains an embedded Klein bottle. If (2),  $S = A(\sigma) \cup B \cup A(\tau)$  is a Klein bottle that self-intersects in a single double-curve (note that the core of  $B$  cannot be a meridian of  $H_W, H_B$  else we obtain a projective plane from  $A(\sigma)$ ). Thus we may assume  $A(\sigma), A(\tau)$  are disjoint from  $B$  except along  $a(\sigma), a(\tau)$ ). The two preimage curves are disjoint from the cores of each of  $A(\sigma), A(\tau)$  and  $B$ , and consequently bound disjoint disks, Möbius bands in the preimage. We may surger along the double curve to obtain an embedded projective plane or Klein bottle in  $M$ .  $\square$

## 5 Combinatorics

Let  $G_Q, G_F$  be the graphs of intersections defined in the proof of [Theorem 2.4](#).

### 5.1 Great webs

Say a label around a vertex of a subgraph  $\Lambda$  of  $G_Q$  is a *ghost label* of  $\Lambda$  if no edge of  $\Lambda$  is incident to the vertex at that label. A *ghost edge* is an edge of  $G_Q$  incident to a ghost label. Let  $\ell$  denote the number of ghost labels, or equivalently the number of ghost edges counted with multiplicity. Recall that  $t = |K \cap \widehat{F}|$  and hence it is the number of vertices of  $G_F$ .

A  *$g$ -web*  $\Lambda$  is a connected subgraph of  $G_Q$  whose vertices are parallel ([Section 3](#)) and has at most  $t + 2g - 2$  ghost labels:  $\ell \leq t + 2g - 2$ . If  $U$  is a component of  $\widehat{Q} - \Lambda$  then we say  $D = \widehat{Q} - U$  is a *disk bounded by  $\Lambda$* . A *great  $g$ -web* is a  $g$ -web  $\Lambda$  such that there is a disk bounded by  $\Lambda$  containing only vertices of  $\Lambda$ . When  $\Lambda$  is a great  $g$ -web this disk is unique (since there must be vertices of  $G_Q$  antiparallel to those in  $\Lambda$ ) and so we say it is *the* disk bounded by  $\Lambda$ .

For each label  $x$ , the subgraph of a great  $g$ -web  $\Lambda$  consisting of all vertices of  $\Lambda$  and edges of  $\Lambda$  with an endpoint labeled  $x$  is denoted  $\Lambda_x$ . Say an  $x$ -label on a vertex of  $\Lambda_x$  is a *ghost  $x$ -label* if the edge incident to it does not belong to  $\Lambda_x$ . Let  $\ell_x$  denote the total number of ghost  $x$ -labels of  $\Lambda_x$ . Observe that a ghost  $x$ -label of  $\Lambda_x$  is a ghost label of  $\Lambda$ .

Given a great  $g$ -web  $\Lambda$  and a disk  $D$  bounded by  $\Lambda$  containing only vertices of  $\Lambda$ , the disk  $D_\Lambda$  that is the closure of  $\widehat{Q} - D$  is the *outside face* of  $\Lambda$ ; all other faces of  $\Lambda$  are *ordinary faces* and are contained in  $D$ . A corner ([Section 3](#)) of a vertex  $v$  of  $\Lambda$  is *outside* or *ordinary* according to whether it is the corner of an outside or ordinary face. A vertex  $v$  of  $\Lambda$  is an *outside vertex* if and only if it has an outside corner, otherwise it is an *ordinary vertex*.

**Lemma 5.1** [15, Theorem 6.1] *Since  $\Delta \geq 3 > 2$  and  $\widehat{F}$  has genus 2, then  $G_Q$  contains a great 2–web  $\Lambda$ .*

### 5.2 The abundance of bigons

Let  $\Lambda$  be a great  $g$ –web of  $G_Q$ . When  $g = 2$  its existence is ensured by Lemma 5.1. For any label  $x$ , regard  $\Lambda_x$  as a graph in  $\widehat{Q}$ . Refer to the sole face of  $\Lambda_x \subset \widehat{Q}$  that contains the outside face of  $\Lambda$  as the *outside face of  $\Lambda_x$*  (similarly for a component of  $\Lambda_x$ ).

**Lemma 5.2** *If  $\Delta \geq 3$  and  $t \geq g - 1$  then either  $\Lambda_x$  contains a bigon which is not its outside face for each label  $x$  or  $\Lambda$  has just one vertex and  $t = g - 1$ .*

**Proof** First consider the case that  $\Lambda$  has just one vertex. Then  $\Lambda$  has no edges, else  $G_Q$  would have a monogon. Therefore  $\Delta t = \ell \leq t + 2g - 2$ . Since  $\Delta \geq 3$ , this implies  $t \leq g - 1$ . Thus if  $t \geq g - 1$  and  $\Lambda$  has just one vertex, then  $t = g - 1$ .

Now fix a label  $x$ . We will show if  $\Lambda_x$  does not contain a bigon but has more than one vertex, then  $g - 2 \geq t$ .

First we assume  $\Lambda_x$  is connected. Assume the outside face has  $k \geq 1$  corners. We count vertices (corners) and edges in a face locally, ie the same edge or vertex of  $G_Q$  may contribute more than once to  $k$ .

Let  $V$ ,  $E$ , and  $F$  denote the number of vertices, edges, and faces of  $\Lambda_x$ . By the Parity Rule (Section 3),  $E = \Delta V - \ell_x$ . Let  $k_i$  be the number of corners in the outside face of  $\Lambda_x$  with exactly  $i$  ghost  $x$ –labels. Then  $k = \sum_{i=0}^{\Delta} k_i$  and  $\ell_x = \sum_{i=1}^{\Delta} i k_i$ . (Recall that a vertex has at most  $\Delta$   $x$ –labels.)

Suppose  $\Lambda_x$  contains no bigons other than possibly its outside face. Then

$$\begin{aligned} 2E &\geq 3(F - 1) + k = 3F + (k - 3), \\ F &\leq 2/3E - 1/3(k - 3), \\ 2 = V - E + F &\leq V - E + 2/3E - 1/3(k - 3), \\ E &\leq 3V - (k + 3). \end{aligned}$$

Hence  $(\Delta - 3)V + (k + 3) \leq \ell_x$ . Because the outer face of  $\Lambda_x$  has  $k$  corners, some corner(s) of the outer face must have more than one ghost  $x$ –label.

Let  $V_2$  be the number of corners in the outside face with exactly 2 ghost  $x$ –labels. Let  $V_{\geq 3}$  be the number of corners in the outside face with at least 3 ghost  $x$ –labels. Since a

corner may have at most  $\Delta$  ghost  $x$ -edges,  $\Delta \geq 3$ , and  $k + \Delta \leq (\Delta - 3)V + (k + 3) \leq \ell_x$ , then

$$(\dagger) \quad V_2 + 2V_{\geq 3} \geq 3 \quad \text{and} \quad V_2 + V_{\geq 3} \geq 2.$$

(The count  $k + \Delta \leq \ell_x$  shows that, at worst, each of the  $k$  corners has at least one ghost  $x$ -edge though there are at least  $\Delta$  more. Since a corner has at most  $\Delta$  ghost  $x$ -labels, there must be at least 2 corners with more than one ghost  $x$ -label. Hence  $V_2 + V_{\geq 3} \geq 2$ . Since  $\Delta \geq 3$ , the possible distributions of these last  $\Delta$  ghost  $x$ -labels implies  $V_2 + 2V_{\geq 3} \geq 3$ .)

Since there are  $t - 1$  labels between two consecutive ghost  $x$ -labels on a corner of the outside face, there are at least  $(t + 1)V_2$  ghost labels on all corners of the outside face with exactly 2 ghost  $x$ -labels. (No ghost labels of  $\Lambda$  are separated by a cycle of edges in  $\Lambda$ .) Similarly there are at least  $(2t + 1)V_{\geq 3}$  ghost labels on all corners of the outside face with at least 3 ghost  $x$ -labels. Therefore if  $\ell$  is the total number of ghost labels for  $\Lambda$ , then

$$(\ddagger) \quad t + 2g - 2 \geq \ell \geq (t + 1)V_2 + (2t + 1)V_{\geq 3} = t(V_2 + 2V_{\geq 3}) + (V_2 + V_{\geq 3}) \geq 3t + 2.$$

Hence  $g - 2 \geq t$ .

Now assume  $\Lambda_x$  is not connected. The argument above shows that an innermost component of  $\Lambda_x$  must have ghost  $x$ -edges, so there is no nesting of components of  $\Lambda_x$ . This implies no component of  $\Lambda_x$  has a monogon. Furthermore, the argument above shows that  $(\dagger)$  holds for each connected component of  $\Lambda_x$  with at least 2 vertices, using  $V_2$  and  $V_{\geq 3}$  to count the corners of the component's outside face.

Define a *ghost  $x$ -interval* of  $\Lambda$  to be an interval of labels on a fat vertex of  $\Lambda$  that lies between consecutive ghost  $x$ -labels such that no  $x$ -edge of  $\Lambda$  is incident to this interval.

Consider a component  $\Lambda_x^a$  of  $\Lambda_x$ . To each ghost  $x$ -interval,  $I$ , between consecutive ghost  $x$ -labels on a corner of its outside face we associate at least  $t - 1$  different ghost labels of  $\Lambda$ : If all labels of  $I$  are already ghost labels of  $\Lambda$ , then we use these. If there is an edge of  $\Lambda$  incident to  $I$ , then (because the ghost  $x$ -labels bounding the interval cannot be separated by a cycle in  $\Lambda$ ) removing from  $\Lambda$  all edges,  $\mathcal{E}$ , incident to  $I$  produces a disconnected graph of which one component contains our initial component  $\Lambda_x^a$ . Let  $C_I$  be another component of  $\Lambda - \mathcal{E}$ . To  $I$  we associate the  $t - 1$  ghost labels within the ghost  $x$ -interval given by the following Claim. Note that if  $I, I'$  are distinct ghost  $x$ -intervals on  $\Lambda_x^a$ , then  $C_I, C_{I'}$  cannot share vertices, hence the assigned ghost labels will be different.

**Claim 5.3** *There is a ghost  $x$ -interval on a vertex of  $C_I$  consisting entirely of ghost labels.*

**Proof**  $C_I$  must contain a component  $\Lambda_x^b$  of  $\Lambda_x$  such that at most one ghost  $x$ -interval in  $\Lambda_x^b$  has edges of  $\Lambda$  incident; else there would be a cycle of edges of  $\Lambda$  separating ghost  $x$ -edges. (Start at  $I$  and follow an edge of  $\mathcal{E}$  to  $C_I$ . Create a cycle by always leaving a ghost  $x$ -interval via an edge of  $\Lambda$  or connecting to a ghost  $x$ -interval by  $x$ -edges of  $\Lambda$ .) If  $\Lambda_x^b$  has at least two vertices, then by  $(\dagger)$  there must be another ghost  $x$ -interval consisting entirely of ghost labels. If  $\Lambda_x^b$  has only one vertex then its labels outside this single ghost  $x$ -interval, at least  $\Delta t - (t - 1) \geq 2t + 1$  of them, are all ghost labels.  $\square$

If  $\Lambda_x^a$  has at least two vertices, then  $(\ddagger)$  still holds with  $V_2$  and  $V_{\geq 3}$  counting corners of  $\Lambda_x^a$  and using the associated ghost labels above. If  $\Lambda_x^a$  has just one vertex, then since it has no edges (else  $G_Q$  would have a monogon) and there is another component of  $\Lambda_x$  we may associate, as above, more than  $\Delta t$  ghost labels to  $\Lambda_x^a$ . In either case we may conclude that  $t < g - 1$ .  $\square$

**Corollary 5.4** *If  $\Delta \geq 3$  and  $g = 2$  then  $\Lambda_x$  contains a bigon for each label  $x$ . Thus, for each label  $x$ ,  $\Lambda$  contains a proper ESC or SC with (outermost) label  $x$ .*

**Proof** Apply Lemma 5.2 with  $g = 2$  to get the first statement. Note that  $t > 1$ . The second statement follows immediately from the first, as a bigon face of  $\Lambda_x$  corresponds to an ESC or SC of  $\Lambda$ .  $\square$

### 5.3 Special vertices

By Lemma 5.1 we have a great 2-web  $\Lambda \subset G_Q$  that resides in the sphere  $\widehat{Q}$ .

Here we seek the existence of a so-called *special* vertex of our great 2-web  $\Lambda$  with a large number of ordinary corners incident to bigons, though permitting fewer bigons at the expense of a greater number of trigons.

**Definition 5.5** Let  $\mathcal{V}$  be the set of vertices of  $\Lambda$ . At each vertex  $v \in \mathcal{V}$  let  $\phi_i(v)$  count the number of its ordinary corners incident to  $i$ -gon faces of  $\Lambda$ . We have that  $\sum_i \phi_i(v) \leq \Delta t$  for each vertex  $v$ . This is an equality if and only if  $v$  is ordinary. Since only the outside face of  $\Lambda$  may be a monogon,  $\phi_1(v) = 0$  for all  $v$ . Thus we shall write  $\phi(v) = (\phi_2(v), \phi_3(v), \dots)$ .

**Definition 5.6** Let  $F_i$  denote the number of faces of  $\Lambda$  (including the outside face) that are  $i$ -gons; let  $\bar{F}_i$  denote the number of ordinary faces of  $\Lambda$  that are  $i$ -gons. The total number of faces of  $\Lambda$  is thus  $F = \sum_i F_i = 1 + \sum_i \bar{F}_i$ . Furthermore  $i \bar{F}_i = \sum_{v \in \Lambda} \phi_i(v)$  for each  $i$  and also  $2E = \sum_i i F_i$ .

**Definition 5.7** Let  $\rho = (\rho_2, \rho_3, \rho_4, \dots)$  be a sequence of nonnegative integers. We say that  $\rho$  is of type  $[k_2, \dots, k_m]$  if

$$\rho_2 = k_2, \quad \dots, \quad \rho_{m-1} = k_{m-1} \quad \text{and} \quad \rho_m \geq k_m.$$

A vertex  $v$  is said to be of type  $[k_2, \dots, k_m]$  if  $\phi(v)$  is of type  $[k_2, \dots, k_m]$ .

Each integer  $N \geq 2$  gives a weight to which we associate a measure of a sequence of integers  $\rho = (\rho_2, \rho_3, \dots)$ :

$$\alpha_N(\rho) = \sum_{i=2}^N \binom{N-i}{i} \rho_i.$$

We say that  $v$  is a special vertex (of weight  $N$ ) of  $\Lambda$  if

$$\alpha_N(\phi(v)) > \frac{N-2}{2} \Delta t - N.$$

Recall that since  $\Lambda$  is a 2-web, the number of ghost labels  $\ell$  is at most  $t + 2$ . Hence setting  $V$  to be the total number of vertices of  $\Lambda$  and  $E$  to be the number of edges, then  $2E = \Delta t V - \ell$ .

**Proposition 5.8** Assume the outside face of  $\Lambda$  is a  $k$ -gon. Then for any integer  $N \geq 2$  there exists a vertex  $v$  of  $\Lambda$  with

$$\alpha_N(\phi(v)) \geq \left( \binom{N-2}{2} \Delta t - N \right) + \frac{k + N - \binom{N-2}{2} \ell}{V}$$

with equality only if  $\bar{F}_i = 0$  for  $i > N$ . In particular, using that  $\ell \leq t + 2$ ,

$$\alpha_N(\phi(v)) \geq \left( \binom{N-2}{2} \Delta t - N \right) + \frac{k + 2 - \binom{N-2}{2} t}{V}.$$

**Proof** Multiplying the equation  $\sum F_i = F = E - V + 2$  by  $N$  and subtracting  $\sum i F_i = 2E$  yields:

$$\sum_{i=2}^N (N-i)F_i = (N-2)E - NV + 2N,$$

$$\sum_{i=2}^N (N-i)F_i = \left(\frac{N-2}{2}\right)2E - NV + 2N + \sum_{i>N} (i-N)F_i,$$

$$\sum_{i=2}^N (N-i)\bar{F}_i = \left(\frac{N-2}{2}\right)(\Delta t V - \ell) - NV + 2N + \sum_{i>N} (i-N)\bar{F}_i + (k-N),$$

$$\sum_{i=2}^N (N-i)\bar{F}_i \geq \left(\left(\frac{N-2}{2}\right)\Delta t - N\right)V + \left(k + N - \left(\frac{N-2}{2}\right)\ell\right),$$

with equality only if  $\bar{F}_i = 0$  for  $i > N$ .

Since  $i\bar{F}_i = \sum_{v \in \mathcal{V}} \phi_i(v)$  for all  $i$ ,

$$\sum_{i=1}^N (N-i)\bar{F}_i = \sum_{v \in \mathcal{V}} \sum_{i=1}^N \left(\frac{N-i}{i}\right)\phi_i(v) = \sum_{v \in \mathcal{V}} \alpha_N(\phi(v)).$$

Hence

$$(\diamond) \quad \sum_{v \in \mathcal{V}} \alpha_N(\phi(v)) \geq \left(\left(\frac{N-2}{2}\right)\Delta t - N\right)V + \left(k + N - \left(\frac{N-2}{2}\right)\ell\right).$$

Therefore there exists a vertex  $v$  such that

$$\alpha_N(\phi(v)) \geq \left(\left(\frac{N-2}{2}\right)\Delta t - N\right) + \frac{k + N - \left(\frac{N-2}{2}\right)\ell}{V}$$

as claimed.

Furthermore, using that  $\ell \leq t + 2$ ,

$$\alpha_N(\phi(v)) \geq \left(\left(\frac{N-2}{2}\right)\Delta t - N\right) + \frac{k + 2 - \left(\frac{N-2}{2}\right)t}{V}. \quad \square$$

**Proposition 5.9** *Assume there are  $j$  distinct outside vertices  $v_1, \dots, v_j$  with  $v_i$  contributing  $k_i$  corners to the outside face of  $\Lambda$  (so that the outside face is a  $k$ -gon, where  $k = \sum_{i=1}^j k_i$ ). If  $\Lambda$  has an ordinary vertex, then for any integer  $N \geq 2$  there exists an ordinary vertex  $v$  with*

$$\alpha_N(\phi(v)) > \left(\left(\frac{N-2}{2}\right)\Delta t - N\right) + \frac{N(1 + \frac{1}{2}k - j)}{V - j}.$$



**Proof** Let  $\ell_{v_i}$  be the number of ghost labels incident to the outside vertex  $v_i$ . If  $v_i$  contributes  $k_i$  corners to the outside face, then  $v_i$  has  $\Delta t - \ell_{v_i} - k_i$  ordinary corners. Since there can be no ordinary monogons,

$$\alpha_N(\phi(v_i)) \leq \left(\frac{N-2}{2}\right) (\Delta t - \ell_{v_i} - k_i),$$

where equality is only possible in the event that every ordinary face incident to  $v_i$  is a bigon. Assuming  $\Lambda$  has an ordinary vertex, then this cannot be an equality for every outside vertex. This induces the strict inequality in the calculation below.

Continuing from  $(\diamond)$  in the proof of Proposition 5.8 (which is an equality only if every ordinary face has  $N$  sides or less),

$$\sum_{v \setminus v_1, \dots, v_j} \alpha_N(\phi(v)) + \sum_{i=1}^j \alpha_N(\phi(v_i)) \geq \left(\left(\frac{N-2}{2}\right) \Delta t - N\right) V + \left(k + N - \left(\frac{N-2}{2}\right) \ell\right).$$

Thus

$$\begin{aligned} \sum_{v \setminus v_1, \dots, v_j} \alpha_N(\phi(v)) &\geq \left(\left(\frac{N-2}{2}\right) \Delta t - N\right) (V - j) + \left(\left(\frac{N-2}{2}\right) \Delta t - N\right) j \\ &\quad + \left(k + N - \left(\frac{N-2}{2}\right) \sum_{i=1}^j \ell_{v_i}\right) - \sum_{i=1}^j \alpha_N(\phi(v_i)) \\ &> \left(\left(\frac{N-2}{2}\right) \Delta t - N\right) (V - j) + \left(\left(\frac{N-2}{2}\right) \Delta t - N\right) j \\ &\quad + \left(N + k - \left(\frac{N-2}{2}\right) \sum_{i=1}^j \ell_{v_i}\right) - \sum_{i=1}^j \left(\frac{N-2}{2}\right) (\Delta t - \ell_{v_i} - k_i) \\ &= \left(\left(\frac{N-2}{2}\right) \Delta t - N\right) (V - j) - Nj + (N + k) + \left(\frac{N-2}{2}\right) k \\ &= \left(\left(\frac{N-2}{2}\right) \Delta t - N\right) (V - j) + N(1 + \frac{1}{2}k - j). \end{aligned}$$

Thus there exists an ordinary vertex  $v \in \mathcal{V} \setminus v_1, \dots, v_j$  such that

$$\alpha_N(\phi(v)) > \left(\left(\frac{N-2}{2}\right) \Delta t - N\right) + \frac{N(1 + \frac{1}{2}k - j)}{V - j}. \quad \square$$

**5.3.1 The existence of special vertices** In most of the following lemmas, we conclude that our great 2-web  $\Lambda$  either has a special vertex or a large number of mutually parallel edges. In the applications of these lemmas such numbers of mutually parallel edges will be prohibited thereby implying the existence of a special vertex.

**Lemma 5.10** *If  $t = 8$  then  $\Lambda$  either has a special vertex  $v$  of weight  $N = 3$  or 19 mutually parallel edges.*

**Proof** By Proposition 5.8 there exists a vertex  $v \in \Lambda$  such that

$$\alpha_3(\phi(v)) \geq (4\Delta - 3) + \frac{k-2}{V},$$

where  $k$  is the length of the outside face. Thus if  $k \geq 3$  then  $v$  is special.

If  $k = 1$  or 2, then let  $j \leq k$  be the number of vertices contributing to the  $k$  outside corners. If  $\Lambda$  has an ordinary vertex, then by Proposition 5.9 there exists an ordinary vertex  $v \in \Lambda$  such that

$$\alpha_3(\phi(v)) > (4\Delta - 3) + \frac{3(1 + \frac{1}{2}k - j)}{V - j}.$$

This is the special vertex.

If  $\Lambda$  has no ordinary vertices and  $j = 1$ , then each edge of  $\Lambda$  must bound a monogon. This cannot occur.

Thus we now assume  $\Lambda$  has no ordinary vertices and  $(k, j) = (2, 2)$ . Then all ordinary faces of  $\Lambda$  are bigons. Since there may be at most 10 ghost edges,  $\Lambda$  consists of two vertices and at least  $8\Delta - 5 \geq 19$  mutually parallel edges. □

**Lemma 5.11** *If  $t = 6$  then  $\Lambda$  either has a special vertex of weight  $N = 4$  or 8 mutually parallel edges.*

**Proof** By Proposition 5.8 there exists a vertex  $v \in \Lambda$  such that

$$\alpha_4(\phi(v)) \geq (6\Delta - 4) + \frac{k-4}{V},$$

where  $k$  is the length of the outside face. Thus if  $k \geq 5$  then  $v$  is special. Therefore assume  $k = 1, 2, 3$ , or 4 and  $j \leq k$  is the number of vertices contributing to the  $k$  outside corners.

If  $\Lambda$  has no ordinary vertex then the only vertices of  $\Lambda$  are the  $j$  outside vertices. Consider the reduced graph of  $\Lambda$  obtained by amalgamating mutually parallel edges in the disk bounded by  $\Lambda$ . Assuming  $\Lambda$  does not have 8 mutually parallel edges, each edge of this reduced graph represents at most 7 edges. Thus a vertex (of this reduced graph) of valence  $n$  must have at least  $6\Delta - 7n$  ghost edges. Since  $\Delta \geq 3$ , a valence 1 vertex has at least 11 ghost edges and a valence 2 vertex has at least 4 ghost edges. Since the total number of incidences of ghost edges to  $\Lambda$  is at most 8 there can be no valence 1 vertices and no more than two valence 2 vertices. Hence it

must be that  $(k, j) = (4, 4)$ , where there the reduced graph has two valence 2 vertices. The remaining two vertices of  $\Lambda$  have no ghost labels and must be of valence 3. Both these vertices have  $\phi = (6\Delta - 3, 2)$  and are thus special vertices of weight  $N = 4$ .

Now assume there is an ordinary vertex in  $\Lambda$ . Then by Proposition 5.9 there exists an ordinary vertex  $v \in \Lambda$  such that

$$\alpha_4(\phi(v)) > (6\Delta - 4) + \frac{4(1 + \frac{1}{2}k - j)}{V - j}.$$

Hence  $v$  is necessarily special unless  $(k, j)$  is  $(4, 4)$  or  $(3, 3)$ . For these two situations we must push the proof of Proposition 5.9 further:

Let  $v_1, \dots, v_k$  be the outside vertices of  $\Lambda$ . Since  $k = j$ , each outside vertex has just one outside corner. Again  $\ell_{v_i}$  denotes the number of ghost labels on the outside corner of  $v_i$ . Then  $v_i$  has  $6\Delta - \ell_{v_i} - 1$  ordinary corners which occur consecutively.

Assume  $\Lambda$  does not have 8 mutually parallel edges. Then there may be at most 6 consecutive bigons. Let  $n_i$  be the number of ordinary corners of  $v_i$  that do not belong to bigons. Then

$$\begin{aligned} \alpha_4(\phi(v_i)) &\leq \left(\frac{N-2}{2}\right) (\Delta t - \ell_{v_i} - 1 - n_i) + \left(\frac{N-3}{3}\right) n_i \\ &= \left(\frac{N-2}{2}\right) (\Delta t - \ell_{v_i} - 1) - \frac{N}{6} n_i \end{aligned}$$

and hence

$$\alpha_4(\phi(v_i)) \leq (6\Delta - \ell_{v_i} - 1) - \frac{2}{3} n_i.$$

If for some  $i$ ,  $\ell_{v_i} = 0$  and  $n_i \leq 2$ , then  $v_i$  is a special vertex of weight  $N = 4$ . So we assume this is not the case. Since  $\Delta \geq 3$ ,  $n_i \leq 1$  implies that  $n_i = 1$  and  $\ell_{v_i} \geq 4$ . If there are two  $v_i$  with  $n_i = 1$ , then, as  $\ell = \sum \ell_{v_i} \leq t + 2 = 8$ , all others have no ghost labels. Together these observations mean that  $\sum_{i=1}^k n_i \geq 2k - 1$ .

Hence

$$\begin{aligned} \sum_{i=1}^k \alpha_4(\phi(v_i)) &\leq \sum_{i=1}^k ((6\Delta - \ell_{v_i} - 1) - \frac{2}{3} n_i) = (6\Delta - 1)k - \sum_{i=1}^k \ell_{v_i} - \sum_{i=1}^k \frac{2}{3} n_i \\ &\leq (6\Delta - 1)k - \ell - \frac{2}{3}(2k - 1). \end{aligned}$$

Thus, again continuing from ( $\diamond$ ) in the proof of Proposition 5.8 (as we did in the proof of Proposition 5.9), where now  $j = k$ ,

$$\sum_{\mathcal{V} \setminus \{v_1, \dots, v_k\}} \alpha_N(\phi(v)) \geq \left( \left( \frac{N-2}{2} \right) \Delta t - N \right) (V - k) + \left( \left( \frac{N-2}{2} \right) \Delta t - N \right) k + \left( k + N - \left( \frac{N-2}{2} \right) \ell \right) - \sum_{i=1}^k \alpha_N(\phi(v_i))$$

so that

$$\begin{aligned} \sum_{\mathcal{V} \setminus \{v_1, \dots, v_k\}} \alpha_4(\phi(v)) &\geq (6\Delta - 4)(V - k) + (6\Delta - 4)k + (4 + k - \ell) - \sum_{i=1}^k \alpha_4(\phi(v_i)) \\ &\geq (6\Delta - 4)(V - k) + (6\Delta - 4)k + (4 + k - \ell) - (6\Delta - 1)k + \ell + \frac{2}{3}(2k - 1) \\ &= (6\Delta - 4)(V - k) - 4k + 4 + k + k + \frac{4}{3}k - \frac{2}{3} \\ &= (6\Delta - 4)(V - k) + \frac{10 - 2k}{3}. \end{aligned}$$

Therefore there is an ordinary vertex  $v \in \mathcal{V} \setminus \{v_1, \dots, v_k\}$  such that

$$\alpha_4(\phi(v)) \geq (6\Delta - 4) + \frac{10 - 2k}{3(V - k)}.$$

Since  $k = 3$  or  $4$ ,  $10 - 2k > 0$ . Hence

$$\alpha_4(\phi(v)) > 6\Delta - 4.$$

Thus  $v$  is a special vertex. This completes the proof of Lemma 5.11. □

**Lemma 5.12** *If  $t = 4$  then  $\Lambda$  either has a special vertex  $v$  of weight  $N = 4$  or 9 mutually parallel edges.*

**Proof** By Proposition 5.8 there exists a vertex  $v \in \Lambda$  such that

$$\alpha_4(\phi(v)) \geq (4\Delta - 4) + \frac{k - 2}{V},$$

where  $k$  is the length of the outside face. Thus if  $k \geq 3$  then  $v$  is special.

If  $\Lambda$  has an ordinary vertex, then Proposition 5.9 implies there is a special vertex of weight  $N = 4$  if  $k = 1, 2$ . Thus we assume  $\Lambda$  has no ordinary vertex and  $k = 1, 2$ . Let  $j \leq k$  be the number of vertices contributing to the outside corners.

Since  $\Lambda$  contains no ordinary vertices, any loop edge must bound a monogon (1-sided face), which does not happen in  $G_Q$ . Thus  $j \neq 1$ . Thus  $(k, j) = (2, 2)$ ,  $\Lambda$  consists of

two vertices and all the ordinary faces are bigons between the two vertices. Since there may be at most 6 ghost edges, these bigons must be induced by at least  $4\Delta - 3 \geq 9$  mutually parallel edges.  $\square$

**5.3.2 Types of special vertices** See Definition 5.7 for vertex type.

**Lemma 5.13** A special vertex of weight  $N = 3$  has type  $[t\Delta - 5]$ .

**Proof** If  $v$  is a special vertex of weight  $N = 3$ , then

$$\alpha_3(\phi(v)) = \frac{1}{2}\phi_2(v) > \frac{1}{2}t\Delta - 3.$$

Hence  $\phi_2(v) > t\Delta - 6$ . Thus  $\phi_2(v) \geq t\Delta - 5$  and  $v$  is of type  $[t\Delta - 5]$ .  $\square$

**Lemma 5.14** A special vertex of weight  $N = 4$  has type  $[\Delta t - 5, 4]$ ,  $[\Delta t - 4, 1]$  or  $[\Delta t - 3]$ .

**Proof** If  $v$  is a special vertex of weight  $N = 4$ , then

$$\alpha_4(\phi(v)) = \phi_2(v) + \frac{1}{3}\phi_3(v) > \Delta t - 4.$$

Hence  $3\phi_2(v) + \phi_3(v) > 3\Delta t - 12$ . Then since  $\phi_2(v) + \phi_3(v) \leq \Delta t$ , we have  $2\phi_2(v) \geq 2\Delta t - 11$ . Thus  $\phi_2(v) \geq \Delta t - 5$ .

In order to maintain that  $\alpha_4(\phi(v)) > \Delta t - 4$ ,

- if  $\phi_2(v) = \Delta t - 5$  then  $\phi_3(v) \geq 4$ ;
- if  $\phi_2(v) = \Delta t - 4$  then  $\phi_3(v) \geq 1$ ;
- if  $\phi_2(v) = \Delta t - 3$  then  $\phi_3(v) \geq 0$ .

The conclusion now follows.  $\square$

## 6 Elementary surfaces in genus 2 handlebodies

Handlebodies are irreducible. Every properly embedded connected surface in a handlebody is either compressible,  $\partial$ -compressible, the sphere or the disk.

Throughout this article we will repeatedly be considering disks, annuli and Möbius bands that are properly embedded in a genus 2 handlebody  $H$  and the results of chopping the handlebody along these surfaces.

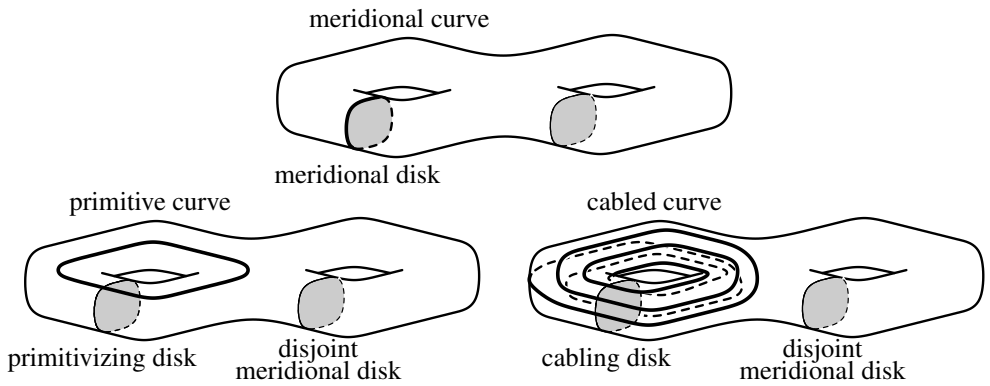

Figure 10

## 6.1 Definitions and notation

On the boundary of a solid torus  $\mathcal{T}$  a nonseparating simple closed curve  $c$  is:

- *Meridional* if it bounds a (meridional) disk in  $\mathcal{T}$ .
- *Longitudinal* (or *primitive*) if it transversely intersects a meridian of  $\mathcal{T}$  once and thus runs once around  $\mathcal{T}$ .
- *Cabled* if it is neither meridional nor longitudinal and thus runs more than once around  $\mathcal{T}$ .

Analogously, there are three notable types of nonseparating simple closed curves  $c$  on the boundary of a genus 2 handlebody  $H$  depicted in Figure 10.

- If  $c$  bounds a disk in  $H$ , then  $c$  is *meridional* or a *meridian*. The disk is a compressing disk which, in this case, we also describe as *meridional*. (Note: In later sections we refer to any compressing disk for the handlebody to be a meridian, regardless of whether or not it is separating.)
- If there is a compressing disk of  $H$  whose boundary transversely intersects  $c$  once, then  $c$  is *primitive*. We say such a meridional compressing disk is a *primitivizing* disk for  $c$ . Given a primitivizing disk for a primitive curve there is necessarily a meridional compressing disk disjoint from both.
- If  $c$  is neither meridional nor primitive and there is a disjoint meridional compressing disk for  $H$  then  $c$  is *cabled*. A meridional disk of  $H$  whose boundary transversely intersects  $c$  nontrivially and coherently (with respect to some chosen orientations) is a *cabling* disk if there is another meridional disk disjoint from both it and  $c$ .

Indeed, in each of the three cases there is a nonseparating compressing disk  $D$  for  $H$  that is disjoint from  $c$ . Then  $c$  is an essential simple closed curve on the boundary of the solid torus  $H \setminus D$ . Hence  $c$  is either meridional on  $H \setminus D$  and  $H$ , longitudinal on  $H \setminus D$  and primitive on  $H$ , or wound  $n > 1$  times longitudinally on  $H \setminus D$  and cabled on  $H$ .

Denote the attachment of a 2-handle to  $H$  along  $c$  by  $H\langle c \rangle$ .

- If  $c$  is primitive, then  $H\langle c \rangle$  is a solid torus.
- If  $c$  is cabled, then  $H\langle c \rangle$  is the connect sum of a solid torus and a nontrivial lens space.

### 6.2 Disks in genus 2 handlebodies

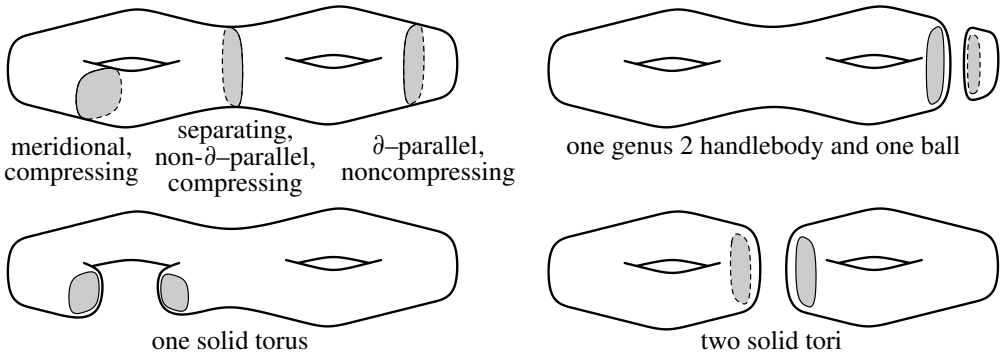

Figure 11

Let  $D$  be a disk properly embedded in the genus 2 handlebody  $H$ . Then we have the following trichotomy depicted in Figure 11:

- $D$  is a nonseparating compressing disk;  $H \setminus D$  is one solid torus.
- $D$  is a separating compressing disk;  $H \setminus D$  is two solid tori.
- $D$  is  $\partial$ -parallel;  $H \setminus D$  is one genus 2 handlebody and one 3-ball.

### 6.3 Annuli

Let  $A$  be an incompressible annulus properly embedded in the genus 2 handlebody  $H$ . Then we have the following trichotomy:

nonseparating annulus  $A$  in handlebody  $H$

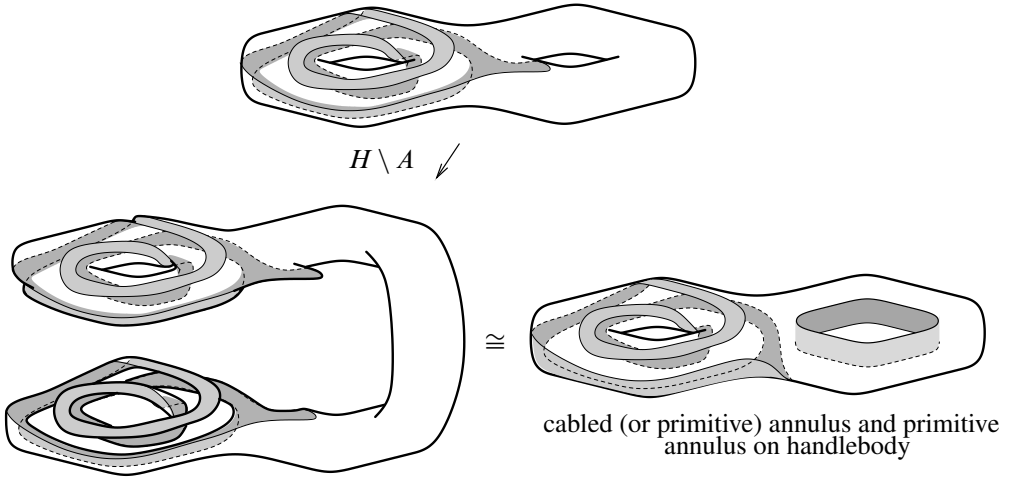

Figure 12

separating, non- $\partial$ -parallel annulus  $A$  in handlebody  $H$

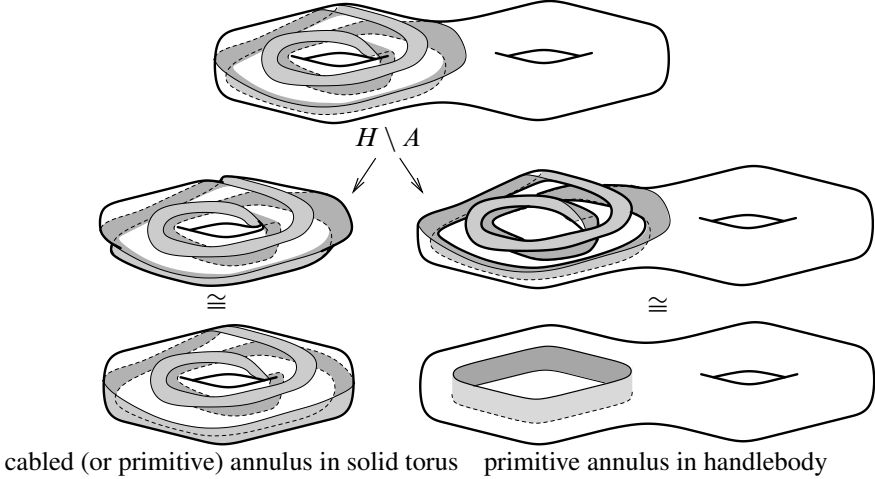

Figure 13

- $A$  is a nonseparating annulus. In this case,  $\partial A$  is nonseparating on  $\partial H$ .
- $A$  is a separating but not  $\partial$ -parallel annulus. In this case,  $\partial A$  also bounds an annulus on  $\partial H$ .
- $A$  is a  $\partial$ -parallel annulus. Again,  $\partial A$  bounds an annulus on  $\partial H$ .

Examples of the first two situations are depicted in Figures 12 and 13.



Let  $d$  be a  $\partial$ -compressing disk for  $A$ . Then  $\partial N(A \cup d) - \partial H$  is a properly embedded disk  $D$  and a parallel copy of  $A$  in  $H$ . Let  $A_+$  be the impression of  $A$  on the side of  $H \setminus A$  containing  $d$ . Let  $A_-$  be the other impression of  $A$ . Then one of the following occurs (situations (2) and (3) are not exclusive):

- (1) If  $D$  is nonseparating, then  $A$  is nonseparating;  $H \setminus A$  is a genus 2 handlebody on which  $A_+$  is primitive and  $A_-$  either primitive or cabled. See Figure 12.
- (2) If  $D$  is separating, then  $A$  is separating;  $H \setminus A$  is a genus 2 handlebody on which  $A_+$  is primitive and a solid torus  $\mathcal{T}$  on which  $A_-$  is either primitive or cabled. See Figure 13.
- (3) If  $D$  is  $\partial$ -parallel, then  $A$  is  $\partial$ -parallel;  $H \setminus A$  is a genus 2 handlebody on which  $A_-$  lies and a solid torus  $\mathcal{T}$  on which  $A_+$  is primitive.

In each of these situations  $d$  becomes a primitivizing disk for  $A_+$  in  $H \setminus A$ .

We say an annulus,  $A$ , in a handlebody,  $H$ , is *primitive* if there is a meridian disk of  $H$  that intersects  $A$  in a single essential arc. Note that an annulus is primitive if and only a component of its boundary is primitive in the ambient handlebody.

### 6.4 Möbius bands

Möbius band  $A$  in genus 2 handlebody  $H$  primitive annulus on genus 2 handlebody  $H \setminus A$

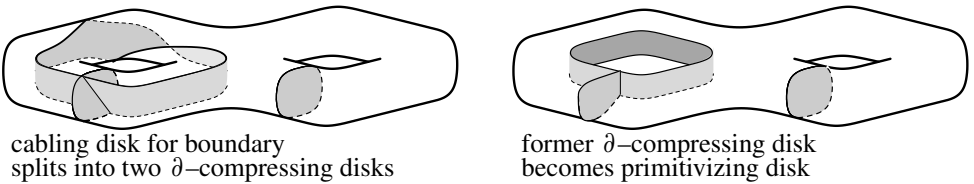

Figure 14

Let  $A$  be an incompressible Möbius band properly embedded in the genus 2 handlebody  $H$ . Let  $d$  be a  $\partial$ -compressing disk for  $A$ . Then  $\partial N(A \cup d) - \partial H$  is a properly embedded disk  $D$ . The disk  $D$  is separating and not  $\partial$ -parallel in  $H$ . Therefore  $H \setminus D$  is two solid tori, one of which contains the Möbius band  $A$ . Because there is a unique embedding of a Möbius band in a solid torus (up to homeomorphism):

- Up to homeomorphism, there is a unique embedding of a Möbius band  $A$  in a genus 2 handlebody  $H$ ;  $H \setminus A$  is a genus 2 handlebody on which the annular impression of  $A$  is primitive.

A  $\partial$ -compressing disk for  $A$  in  $H$  becomes a primitivizing disk for the impression of  $A$  in  $H \setminus A$ . This is depicted in Figure 14.

## 6.5 Cores of handlebodies

A curve embedded in the interior of the solid torus  $D^2 \times S^1$  is a *core* if it is isotopic to  $\{z\} \times S^1$  for some point  $z \in D^2$ . A curve  $c$  embedded in the interior of a handlebody  $H$  is a *core* if it is the core of a solid torus connect summand of  $H$ . This is equivalent to saying  $c$  is isotopic to a primitive curve in  $\partial H$ .

## 7 Obtaining Dyck's surface by surgery

A closed, connected, compact, nonorientable surface with Euler characteristic  $-1$  is the connect sum of three projective planes. It is known as a *cross cap number 3 surface* and as *Dyck's surface* [11].

If a knot  $K'$  in  $S^3$  has maximal Euler characteristic spanning surface  $S$  with  $\chi(S) = -1$  (so that  $K'$  has genus 1 or cross cap number 2) then surgery on  $K'$  along a slope  $\gamma$  of distance 2 from  $\partial S$  produces a manifold with Dyck's surface embedded in it. There is a Möbius band embedded in the surgery solid torus whose boundary coincides with  $\partial S$  so that together they form an embedded Dyck's surface  $\tilde{S}$ . The core of the surgery solid torus is the core of the Möbius band, and hence the surgered knot lies as a simple closed curve on  $\tilde{S}$ . Furthermore, such a surgery slope  $\gamma$  may be chosen so that it has any desired odd distance  $\Delta = \Delta(\gamma, \mu)$  from the  $S^3$  meridian  $\mu$  of  $K'$ . We conjecture that this is the only way a Dyck's surface arises from a nonintegral Dehn surgery on a hyperbolic knot:

**Conjecture 7.1** *Let  $K'$  be a hyperbolic knot in  $S^3$  and assume that  $K'(\gamma)$  contains an embedded Dyck's surface. If  $\Delta = \Delta(\gamma, \mu) > 1$ , where  $\mu$  is a meridian of  $K'$ , then there is an embedded Dyck's surface,  $\hat{S} \subset K'(\gamma)$ , such that the core of the attached solid torus in  $K'(\gamma)$  can be isotoped to an orientation-reversing curve in  $\hat{S}$ . In particular,  $K'$  has a spanning surface with Euler characteristic  $-1$ .*

The following goes a long way towards verifying this conjecture.

**Theorem 7.2** *Let  $K'$  be a hyperbolic knot in  $S^3$  and assume that  $M = K'(\gamma)$  contains an embedded Dyck's surface. If  $\Delta = \Delta(\gamma, \mu) > 1$ , where  $\mu$  is a meridian of  $K'$ , then there is an embedded Dyck's surface in  $M$  that intersects the core of the attached solid torus in  $M$  transversely once.*

**Proof** The proof of this Theorem occupies most of this section. Initially it closely follows [20, Sections 6 and 7], where an analogous theorem is proven for a Klein bottle. We refer the reader to these sections and note where the proofs diverge in our situation.

For homological reasons (see eg [20, Lemma 6.2]), or just by explicit construction of a closed nonorientable surface in the exterior of  $K'$ , if  $M$  were to contain an embedded closed nonorientable surface, then  $\Delta$  cannot be even. Hence we assume  $\Delta \geq 3$  and odd.

Assume that a Dyck's surface does embed in  $M = K'(\gamma)$ . Note that any embedding of Dyck's surface in  $M$  must be incompressible since otherwise a compression would produce an embedded Klein bottle or projective plane; neither of these may occur since  $\Delta > 1$ .

Let  $K$  be the core of the attached solid torus in  $M = K'(\gamma)$ . As  $S^3$  contains no embedded Dyck's surface there is no such surface in  $M$  that is disjoint from  $K$ . Thus if  $K$  can be isotoped onto a Dyck's surface in  $M$ , it must be as an orientation-reversing curve, and can thus be perturbed to intersect the surface transversely once. So we may assume this does not happen. Among all embeddings of Dyck's surfaces in  $M$  that intersect  $K$  transversely, take  $\widehat{S}$  to be one that intersects  $K$  minimally. Let  $\widehat{T}$  be the closed orientable genus 2 surface that is the boundary of a regular neighborhood of  $\widehat{S}$ . Let  $S$  and  $T$  be the intersection of  $\widehat{S}$  and  $\widehat{T}$  respectively with the exterior  $E$  of  $K'$ . Let  $t = |\partial T| = 2|\partial S|$ . As mentioned above, we assume  $t > 0$ . The goal is to show that  $t = 2$ .

Let  $\widehat{Q}$  be a 2-sphere in  $S^3$ . As in [20], via thin position we may assume  $\widehat{Q}$  intersects  $K'$  (in  $S^3$ ) transversely so that  $Q = \widehat{Q} \cap E$  intersects  $S$  transversely and no arc component of  $Q \cap S$  is parallel in  $Q$  to  $\partial Q$  or parallel in  $S$  to  $\partial S$ . Moreover, as  $T$  "double covers"  $S$ ,  $Q$  intersects  $T$  transversely and no arc component of  $Q \cap T$  is parallel in  $Q$  to  $\partial Q$  or parallel in  $T$  to  $\partial T$ . We may now form the labeled fat vertexed graphs of intersection  $G_Q$  in  $\widehat{Q}$  and  $G_T$  in  $\widehat{T}$  whose edges are the arc components of  $Q \cap T$  as well as the graphs  $G_Q^S$  in  $\widehat{Q}$  and  $G_S$  in  $\widehat{S}$  whose edges are the arc components of  $Q \cap S$ . Furthermore, the incompressibility of  $\widehat{S}$  allows us to assume no disk face of either  $G_Q^S$  or  $G_Q$  contains a simple closed curve component of  $Q \cap S$  or  $Q \cap T$  respectively.

The proofs in [20, Section 2] go through for the pair  $G_Q$  and  $G_T$  after replacing "web" with "2-web" throughout to accommodate that  $T$  has genus 2 rather than 1. In particular, [20, Theorem 6.3] becomes:

**Lemma 7.3**  $G_Q$  contains a great 2-web  $\Lambda$ .

We refer to the side of  $\widehat{T}$  containing  $\widehat{S}$  as *Black* and the other side as *White*. Correspondingly the faces of  $G_Q$  are divided into Black and White faces. Each Black face of  $G_Q$  is a bigon and corresponds to an edge of  $G_Q^S$ .

**Lemma 7.4** (cf [20, Theorem 6.4]) *If  $t \geq 4$  then no Scharlemann cycle in  $G_Q$  of any length bounds a White face.*

**Proof** The proof of [20, Theorem 6.4] goes through replacing the Klein bottle with Dyck’s surface. □

**Lemma 7.5** (cf [20, Theorem 6.5]) *If  $\sigma_1, \sigma_2, \sigma_3$  and  $\sigma_4$  are SCs in  $G_Q$ , then two of them must have the same pair of labels.*

**Proof** Assuming no two of the SCs have the same label pair, it must be that  $t \geq 4$ . Since the faces of each of these SCs must be Black by Lemma 7.4, then their label pairs are all mutually distinct. Hence they give rise to four disjoint Möbius bands properly embedded in the Black side of  $\widehat{T}$ . Their intersections with  $\widehat{S}$  form four mutually disjoint orientation reversing curves. But this contradicts that  $\widehat{S}$  is the connect sum of only three projective planes. □

**Lemma 7.6** (cf [20, Theorem 6.6]) *If  $t \geq 6$  then  $G_Q$  does not contain a 1-ESC (see Section 4.1).*

**Proof** Follow the proof of [20, Theorem 6.6] until the last three sentences. Recall there is a Möbius band  $A$  such that  $\partial A = \widehat{\alpha}$  and the core curve of  $A$  is  $\widehat{\beta}$ . An arc of  $K$  is a spanning arc of  $A$ . On  $\widehat{S}$  the curves  $\widehat{\alpha}$  and  $\widehat{\beta}$  are disjoint, embedded nontrivial loops. On  $\widehat{S}$ ,  $\widehat{\alpha}$  is orientation preserving and  $\widehat{\beta}$  is orientation reversing. A small neighborhood of  $\widehat{\beta}$  on  $\widehat{S}$  is a Möbius band  $B$ .

If  $\widehat{\alpha}$  is separating, then on  $\widehat{S}$  it must bound either a Möbius band, once-punctured Klein bottle, or once-punctured torus  $P$  that is disjoint from  $\widehat{\beta}$ . If  $P$  is a Möbius band, then  $P \cup A$  is a Klein bottle. By assumption (since  $\Delta > 2$ ) this cannot occur. If  $P$  is a once-punctured Klein bottle or once-punctured torus, then  $\widehat{P} = P \cup A$  is a closed nonorientable surface with  $\chi = -1$ . We may now perturb  $\widehat{P}$  to be transverse to  $K$  and have fewer intersections with  $K$ . This contradicts the minimality of  $\widehat{S}$ .

If  $\widehat{\alpha}$  is nonseparating then consider the annulus  $A' = A \setminus \widehat{\beta}$ . Then  $A'$  may be pushed off  $A$  keeping  $\partial A'$  on  $\widehat{S}$  so that  $\partial A'$  is a push-off of  $\widehat{\alpha}$  and  $\partial B$ . Then cutting  $\widehat{S}$  open along  $\widehat{\alpha}$  and  $\partial B$ , we may attach  $A$  and  $A'$  to the resulting boundary components to form  $\widehat{P}$ , a new embedded instance of Dyck’s surface. Again we may now perturb  $\widehat{P}$  to be transverse to  $K$  and have fewer intersections with  $K$ . This contradicts the minimality of  $\widehat{S}$ . □

Let  $\mathcal{L}$  be the set of labels of  $G_Q$  that are labels of SCs in  $G_Q$ .

**Lemma 7.7** (cf [20, Theorem 6.7]) *If  $t \geq 6$  then  $|\mathcal{L}| \geq (4t - 2)/5$ .*

**Proof** The proof is the same as that of [20, Theorem 4.3], using Lemma 7.3 instead of [20, Corollary 2.7] and Lemma 7.6 instead of [20, Theorem 3.2].  $\square$

**Lemma 7.8**  *$t$  is not a positive multiple of 4.*

**Proof** If  $t = 4k$ , then  $|K \cap \widehat{S}| = 2k$ . Therefore  $\widehat{S}$  may be tubed  $k$  times along  $K$  to form a closed nonorientable surface in the exterior of  $K$ . This forms a closed, embedded, nonorientable surface in  $S^3$ : a contradiction.  $\square$

**Lemma 7.9**  $t \leq 6$

**Proof** By Lemma 7.7 if  $t \geq 10$  then there must be at least seven labels that appear as labels of SCs in  $G_Q$ . This contradicts Lemma 7.5. Lemma 7.8 forbids  $t = 8$ . Hence  $t \leq 6$ .  $\square$

**Lemma 7.10** *If  $t = 6$ , then three consecutive bigons in  $\Lambda$  must be Black-White-Black with a Black SC. In particular, there may be at most 4 mutually parallel edges on  $\Lambda$ .*

**Proof** In a stack of three consecutive bigons, each corner has four labels. Since  $t = 6$ , the two sets of four labels of the two corners either completely coincide or overlap in just two labels. The former situation implies the stack is an ESC; this violates Lemma 7.6. The latter situation implies one of the outer bigons is an SC. By Lemma 7.4, this bigon must be Black. The lemma at hand now follows.  $\square$

**Lemma 7.11** *If  $t = 6$ , there cannot be a forked (once) extended Scharlemann cycle (see Section 4.1).*

**Proof** Assume there is a forked extended Scharlemann cycle. By symmetry we may assume, without loss of generality, that it has labels and faces marked as in Figure 15(a). The edges of  $\partial f$  and  $\partial g$  form the subgraph of  $G_T$  shown in Figure 15(b).

Collapse  $N(\widehat{S})$  back down to  $\widehat{S}$  expanding the two faces  $f$  and  $g$  into  $\bar{f}$  and  $\bar{g}$  as shown in Figure 16(a). Since the two  $\overline{34}$ -edges of Figure 15(b) bound a single Black bigon, they are collapsed into one orientation reversing loop on  $G_S$ . Because the other edges of  $\partial f$  and  $\partial g$  belong to distinct bigons, they remain distinct edges of  $\partial \bar{f}$  and  $\partial \bar{g}$ . In particular the two  $\overline{25}$ -edges continue to form an orientation preserving loop on  $G_S$ . The corresponding subgraph of  $G_S$  is shown in Figure 16.

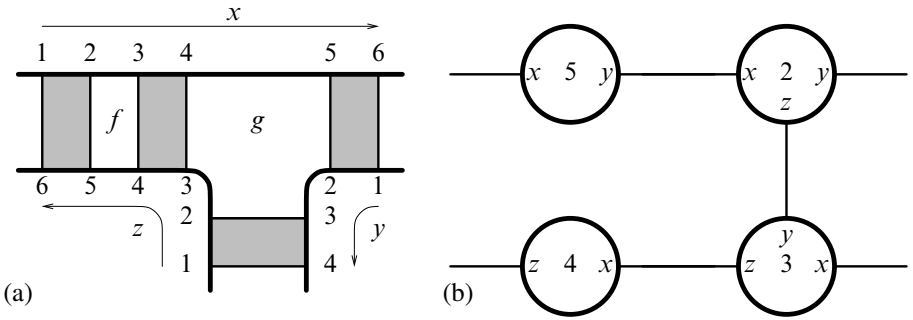

Figure 15

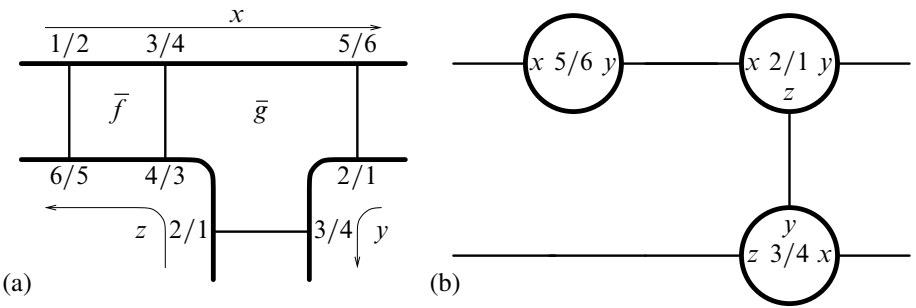

Figure 16

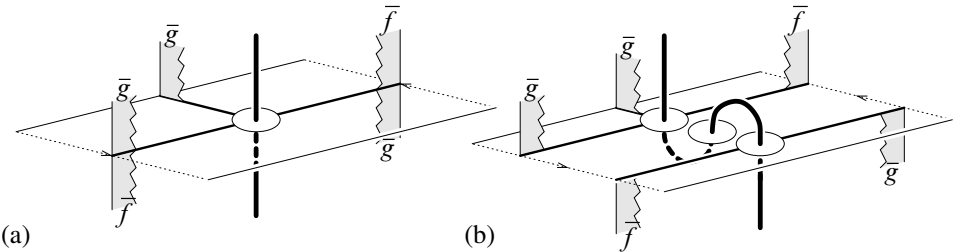

Figure 17

A small collar neighborhood of the  $\overline{34}$ -edge on  $G_S$  is a Möbius band. Nearby, the faces  $\overline{f}$  and  $\overline{g}$  encounter the  $3/4$  vertex as in Figure 17(a). To separate these faces we may perturb  $K$  near the vertex, introducing two new intersections with  $\widehat{S}$  as shown in Figure 17(b). The perturbation is done so that the resulting five edges of  $\partial\overline{f}$  and  $\partial\overline{g}$  are disjoint.

Now we surger  $\widehat{S}$  along the two arcs of  $K$  that form the corners of  $\overline{f}$  and  $\overline{g}$ . This produces a new closed nonorientable surface  $\widehat{R}$  that  $K$  intersects 2 fewer times than

$\widehat{S}$ , though  $\chi(\widehat{R}) = -5$ . Finally, since the boundaries of the faces  $\bar{f}$  and  $\bar{g}$  are disjoint on  $\widehat{R}$  and nonseparating both individually and together, they simultaneously give compressions of  $\widehat{R}$  yielding a closed nonorientable surface  $\widehat{S}'$  with  $\chi(\widehat{S}') = -1$  that  $K$  intersects transversely just once. This contradicts the minimality assumption on  $\widehat{S}$ .  $\square$

**Lemma 7.12** *If  $t = 6$  and  $\Lambda$  contains a Black (34),(56)–bigon, then there is only one parallelism class of Black (12)–SC.*

**Proof** By Lemma 7.7 there must be at least five labels that appear as labels of SCs in  $G_Q$ . Hence all 6 labels are labels of SCs. In particular, there are (12)–, (34)– and (56)–SCs. Choose a representative SC for each Black label pair. Since these Black bigons are disjoint, after their corners are identified along  $K$ , they project to three mutually disjoint orientation reversing simple curves on  $\widehat{S}$ . Thus the complement of these three curves is a thrice-punctured sphere  $P$ . A Black (34),(56)–bigon projects to a properly embedded arc  $a$  on  $\widehat{S}$  connecting two of the punctures on  $P$ . Given a new (12)–SC, it projects to a properly embedded arc  $b$  on  $P$  disjoint from  $a$  and connects the third puncture to itself. Since  $P \setminus a$  is an annulus,  $b$  must be boundary parallel. Hence the new (12)–SC must be parallel to the original representative (12)–SC.  $\square$

**Theorem 7.13**  $t \leq 2$

**Proof** By Lemma 7.9 we have  $t \leq 6$ . Since  $t \neq 4$  by Lemma 7.8, we assume for a contradiction that  $t = 6$ . Since bigons may occur in at most runs of three according to Lemma 7.10, Lemmas 5.14 and 5.11 imply that  $\Lambda$  has a special vertex  $v$  of type  $[6\Delta - 5, 4]$ ,  $[6\Delta - 4, 1]$  or  $[6\Delta - 3]$ . Thus there are bigons at at least  $6\Delta - 5$  corners of  $v$ . By Lemma 7.10 at most  $\frac{3}{4}$  of the corners around a vertex may belong to bigons, however. Hence  $6\Delta - 5 \leq \frac{3}{4}\Delta t = \frac{9}{2}\Delta$  and so  $\Delta \leq \frac{10}{3}$ . Thus  $\Delta = 3$ . Therefore  $v$  has type  $[13, 4]$  or  $[14]$  (which includes both types  $[14, 1]$  and  $[15]$ ).

If  $v$  is of type  $[14]$  then there are at most 4 faces around  $v$  that are not bigons. Hence there must be some run of at least 4 bigons. This contradicts Lemma 7.10.

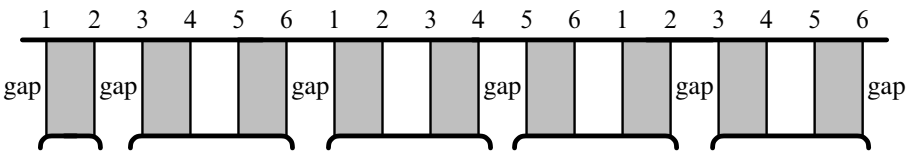

Figure 18

If  $v$  is of type [13, 4] and not type [14] then the 13 bigons must appear around  $v$  as in Figure 18 up to relabeling. In Figure 18, each “gap” marks a nonbigon (the two on the ends mark the same corner); at least 4 mark a trigon. Since each gap must correspond to a White corner at  $v$ , there are either three bigons or just one bigon between gaps. Hence around  $v$  there must be four runs of three consecutive bigons, as pictured, each containing a Black SC by Lemma 7.10.

Because at most one nonbigon around  $v$  is not a trigon, at least two of the trigons lie between two of these runs of bigons. Such a trigon is adjacent to 0, 1 or 2 SCs in the two runs of bigons. Lemma 7.4 prohibits such a trigon being adjacent to 0 SCs. If such a trigon is adjacent to 1 SC, then it must be part of a forked extended Scharlemann cycle as in Figure 15; Lemma 7.11 prohibits this configuration. Hence every such trigon must be adjacent to 2 SCs. This implies that there cannot be three consecutive runs of bigon triples at  $v$ ; that the central gap in Figure 18 is the one not filled by a trigon in  $\Lambda$ . The labeling is now completely forced, except for that of the singleton Black bigon at the left of the figure. It must be a (12)–SC, otherwise one of the trigons on either side is a White SC, contradicting Lemma 7.4. But then there are three (12)–SCs incident to  $v$ , along with a (34),(56)–bigon. Lemma 7.12 implies that there are  $\overline{12}$  edges incident to  $v$  that are parallel on  $G_T$ . The argument of Lemma 8.15 applied to  $G_T, G_Q$  shows that  $K$  is a cable knot; a contradiction.  $\square$

The above lemma provides the conclusion of Theorem 7.2.  $\square$

**Corollary 7.14** *Let  $K'$  be a hyperbolic knot in  $S^3$  and assume that  $M = K'(\gamma)$  contains an embedded Dyck’s surface. If  $\Delta = \Delta(\gamma, \mu) > 1$ , where  $\mu$  is a meridian of  $K'$ , then there is an embedded Dyck’s surface,  $\widehat{S}$ , in  $M$  that intersects transversely once the core,  $K$ , of the attached solid torus. Let  $\widehat{N} = M - N(\widehat{S})$ . Either:*

- (1)  $\partial\widehat{N}$  is incompressible in  $\widehat{N}$  (hence in  $M$ ). Furthermore, either  $K$  can be isotoped in  $M$  onto  $\widehat{S}$  as an orientation-reversing curve, or the twice-punctured, genus 2 surface  $\partial\widehat{N} - N(K)$  is incompressible in the exterior of  $K$ .
- (2)  $\widehat{N}$  is a genus 2 handlebody in which  $K \cap \widehat{N}$  is a trivial arc. That is,  $\widehat{S}$  gives a 1–sided Heegaard splitting for  $M$  with respect to which  $K$  is 1–bridge. In this case,  $K'$  has tunnel number at most 2.

**Proof** Theorem 7.2 provides the Dyck’s surface  $\widehat{S}$  in  $M$  that intersects  $K$  at most once. If  $K$  in  $M$  can be isotoped onto  $\widehat{S}$ , then it must be an orientation-reversing curve in that surface (as  $S^3$  admits no embedded, closed, nonorientable surfaces) and we are done (if  $\widehat{N}$  has incompressible boundary, it is the first conclusion, if not, it is the second as  $M$  is atoroidal and  $\widehat{S}$  is incompressible). So assume  $K$  cannot be



isotoped onto  $\widehat{S}$ . Using a thin position of  $K'$  in  $S^3$ , find surfaces  $\widehat{S}, S, \widehat{T}, T$  as at the beginning of the proof of [Theorem 7.2](#). Now we have  $t = 2$ . By [Lemma 7.3](#),  $G_{\mathcal{Q}}$  contains a great 2–web. This web must contain some White face,  $f$ , which must be a Scharlemann cycle (though not necessarily a bigon). We view  $f$  as giving an essential disk in  $N = \widehat{N} - N(K)$ .

Assume the twice-punctured, genus 2 surface  $\partial\widehat{N} - N(K)$  is incompressible in the exterior of  $K$ . This is equivalent to its incompressibility in  $\widehat{N} - N(K)$ . As  $f$  gives a compressing disk for the boundary of  $N$ , [[9](#), Lemma 2.1.1] (Handle Addition Lemma) implies that  $\partial\widehat{N}$  is incompressible in  $\widehat{N}$  and hence in  $M$ . This is one of the desired conclusions.

So we assume that  $\partial\widehat{N} - N(K)$  is compressible in the exterior of  $K$ , hence in  $N$ . Compress  $\partial\widehat{N} - N(K)$  maximally in  $N$ . As  $K$  is hyperbolic, no component of the result can be an essential annulus in  $N$ . Thus  $\partial\widehat{N} - N(K)$  must compress so that the component containing its boundary is either a twice-punctured, essential torus or a boundary parallel annulus in  $N$ . Assume first it is a twice-punctured, essential torus. That is, we may assume there is a compressing  $D$  for  $\partial\widehat{N}$  that is disjoint from  $K$ , such that some component of  $\partial\widehat{N} - N(K)$  surgered along  $D$  is a twice-punctured essential torus,  $F$ . Let  $\widehat{F}$  be the corresponding torus component obtained by compressing  $\partial\widehat{N}$  along  $D$ . Note that  $\widehat{F}$  is incompressible on the side containing  $\widehat{S}$  as any compressing disk could be taken disjoint from both  $\widehat{S}$  and  $D$ . On the other hand,  $\widehat{F}$  is also incompressible on the side,  $\mathcal{O}$ , lying in  $\widehat{N}$  by [[9](#), Lemma 2.1.1]: surgering the disk  $f$  off of  $D$ , gives rise to an essential disk in  $\mathcal{O} - N(K)$ . Thus,  $\widehat{F}$  is an incompressible torus in  $M$ , a contradiction.

Thus  $\partial\widehat{N} - N(K)$  must compress to a boundary parallel annulus in  $N$ . Thus for the arc  $\kappa = K \cap \widehat{N}$ , there is a disk  $D_{\kappa}$  in  $\widehat{N}$  such that  $\partial D_{\kappa} = \kappa \cup \delta$ , where  $\delta \subset \partial\widehat{N}$ . That is,  $D_{\kappa}$  is a “bridge disk” for  $\kappa$  in  $\widehat{N}$ .

First, assume that  $\partial\widehat{N}$  does not compress in  $\widehat{N}$ .

**Claim 7.15** *Let  $A$  be the annulus  $N \cap N(\kappa)$ , and  $\alpha$  be the core of  $A$ . There are disjoint disks  $D_1, D_2$  properly embedded in  $N$  such that  $\partial D_1$  intersects  $\alpha$  once and  $\partial D_2$  intersects  $\alpha$  algebraically and geometrically  $n > 1$  times.*

**Proof** Initially, set  $D_1 = D_{\kappa}, D_2 = f$ . Isotope  $D_1$  so that it is disjoint from  $D_2$  along  $A$ . Subject to this condition, isotope  $D_1$  to intersect  $D_2$  minimally. If  $D_1, D_2$  are disjoint, we are done. Otherwise, there is an outermost arc of intersection,  $\nu$ , on  $D_1$  cutting off a disk  $d$  which is disjoint from  $D_2$  except along  $\nu$  and also disjoint from  $\alpha$ . By minimality, each side of  $\nu$  in  $D_2$  contains components of  $\partial D_2 \cap A$ . If one

side of  $\nu$  contains a single component of  $\partial D_2 \cap A$ , then add this side of  $\nu$  in  $D_2$  to  $\widehat{d}$ , thereby getting a new disk  $D_1$  disjoint from the disk  $D_2$  as desired. Otherwise, surger  $D_2$  along  $\widehat{d}$  and take either component as the new  $D_2$ . Then  $D_1, D_2$  still satisfy the desired intersection properties with  $\alpha$  but have fewer components of intersection with each other. Repeating, we eventually get disjoint  $D_1, D_2$ .  $\square$

Note that  $N - N(D_1)$  is isotopic to  $\widehat{N}$ . Under this isotopy the disk  $D_2$  becomes a disk in  $\widehat{N}$  whose boundary is easily seen to be nonseparating in  $\partial \widehat{N}$ . This contradicts the incompressibility of  $\partial \widehat{N}$  in  $\widehat{N}$ . Thus it must be that  $K$  could be isotoped onto  $\widehat{S}$ .

Finally, assume  $\partial \widehat{N}$  compresses in  $\widehat{N}$ . Since  $M$  is atoroidal,  $\widehat{N}$  is a genus 2 handlebody. That is,  $\widehat{S}$  is a 1-sided Heegaard surface for  $M$ , and  $D_\kappa$  says that  $K$  is 1-bridge with respect to this splitting. Adding the cores of  $\widehat{N}$  as tunnels to  $K$  gives a genus 3 handlebody isotopic to  $\widehat{N} \cup N(K)$ . Since the neighborhood of a punctured nonorientable surface (in an orientable 3-manifold) is a handlebody, these two tunnels provide a tunnel system for  $K$ , hence also for  $K'$ .  $\square$

## 8 Scharlemann cycles, Möbius bands and annuli

See Section 4 for definitions regarding extended Scharlemann cycles, long Möbius bands and almost properly embedded surfaces. Recall that  $M = K'(\gamma)$  with  $\Delta = \Delta(\gamma, \mu) > 2$ , where  $\mu$  is a meridian of  $K'$ . In particular, as  $K'$  is hyperbolic this implies that  $M$  does not contain an essential 2-sphere, 2-torus, projective plane or Klein bottle and is not a lens space.  $M = H_B \cup_{\widehat{F}} H_W$  is a strongly irreducible genus 2 Heegaard splitting of  $M$ . We assume that thin position of  $K$ , the core of the attached solid torus in  $M$ , with respect to this splitting is the minimal bridge position for  $K$  among all genus 2 Heegaard splittings of  $M$  and that we have surgered  $Q$  to get rid of any simple closed curves of  $Q \cap F$  that are trivial on both.

In this and subsequent sections, we will often need to divide the argument into the two cases:

- **SITUATION NO SCC** There are no closed curves of  $Q \cap F$  in the interior of faces of  $G_Q$ . Thus the annuli, Möbius band constituents of a long Möbius band are each properly embedded on one side of  $\widehat{F}$ .
- **SITUATION SCC** There are closed curves of  $Q \cap F$  in the interior of faces of  $G_Q$ . Recall (Corollary 3.2) that any such must be nontrivial on  $\widehat{F}$  and bound a disk on one side of  $\widehat{F}$ . In this case the annuli, Möbius band constituents of a long Möbius band are each almost properly embedded on one side of  $\widehat{F}$  (Section 4.2).

**Lemma 8.1** *Assume  $A$  is an almost properly embedded Möbius band in one handlebody of a Heegaard splitting  $H_W \cup_{\widehat{F}} H_B$  of a 3-manifold  $M$ . If a core curve of  $A$  lies in a 3-ball in  $M$  then the Heegaard splitting is weakly reducible.*

**Proof**  $\partial A$  cannot be a meridian of either  $H_W$  or  $H_B$  since  $M$  contains no projective planes. But  $\partial A$  can be isotoped into a neighborhood of the core of  $A$ . Hence  $\partial A$  lies in a 3-ball in  $M$ , and Lemma 3.3 says the splitting is weakly reducible.  $\square$

**Lemma 8.2** *The exterior of  $K$  contains no properly embedded, essential, twice-punctured torus with boundary slope  $\gamma$ , the meridian of  $K$  in  $M$ .*

**Proof** Assume  $T$  is a properly embedded, essential, twice-punctured torus contained in  $M - N(K)$ . Then  $T$  caps off to a separating torus  $\widehat{T}$  in  $M$  that is punctured twice by  $K$ ,  $T = \widehat{T} - N(K)$ . Color the two components of  $M \setminus \widehat{T}$  Black and White and denote them  $M_B$  and  $M_W$  respectively.

The thin position argument of [13] shows that we may find a thick sphere  $\widehat{Q}$  for  $K' \subset S^3$  in thin position so that the fat-vertexed graph  $G_Q$  of intersection on  $\widehat{Q}$  between  $Q = \widehat{Q} - N(K')$  and  $F$  in the exterior of  $K$  has no monogons. (A monogon of  $G_Q$  would give a bridge disk for an arc of  $K \setminus \widehat{T}$  and hence give a compression of  $T$ .) We may now follow [20, Lemmas 8.2 and 8.3] to show that both  $M_B - N(K)$  and  $M_W - N(K)$  are genus 2 handlebodies.

Since  $M_B$  is recovered from the handlebody  $M_B - N(K)$  by attaching a 2-handle along the core of the annulus  $\partial(M_B - N(K)) - T$ , the Handle Addition Lemma [9, 2.1.1] implies that  $\widehat{T} = \partial M_B$  is incompressible in  $M_B$ . The same argument shows  $\widehat{T} = \partial M_W$  is also incompressible in  $M_W$ . Thus the torus  $\widehat{T}$  is incompressible in  $M$ , a contradiction since  $M$  is atoroidal.  $\square$

**Lemma 8.3** *Let  $N \subset M$  be a small Seifert fiber space over the disk with two exceptional fibers. Assume  $N$  contains a properly embedded Möbius band  $A$  such that  $\partial A$  does not lie in a 3-ball in  $M$  (for example,  $\partial A$  lies on a genus 2 Heegaard splitting of  $M$ , Lemma 3.3). Furthermore, assume  $K \cap N$  is a spanning arc of  $A$ . Then there is a genus 2 Heegaard splitting of  $M$  in which  $K$  is 0-bridge.*

**Remark 8.4** Note that the proof of Lemma 8.3 actually shows that under the given hypotheses,  $M$  is a Seifert fiber space with at most three exceptional fibers, one of which has order 2. Furthermore, the new splitting constructed is a vertical splitting of the Seifert fiber space and  $K$  is a core of this vertical splitting.

**Proof** Since  $\partial A$ , hence  $N$ , does not lie in a 3–ball in  $M$ , and  $M$  is atoroidal,  $M - \text{Int } N$  must be a solid torus. Let  $T = \partial N$ . As  $\partial N(A) - T$  must be an essential annulus in  $N$ ,  $T - N(K)$  is incompressible in  $N - N(K)$ . Lemma 8.2 implies  $T - N(K)$  must compress in  $(M - \text{Int } N) - N(K)$  to give a boundary parallel annulus. This gives an isotopy of  $K \cap (M - \text{Int } N)$  onto  $T$  through  $M - \text{Int } N$ .

Attaching the 1–handle  $N(K) \cap N$  to  $M - \text{Int } N$  then forms a genus 2 handlebody where  $K$  is isotopic onto its boundary. Since  $N - N(A)$  must be a solid torus,  $N - N(K)$  is a genus 2 handlebody. Thus we have the desired Heegaard splitting.  $\square$

Recall that an ESC is called *proper* if in its corner no label appears more than once. Section 4 describes how an ESC gives rise to an almost properly embedded, long Möbius band.

**Lemma 8.5** *Let  $\sigma$  be a proper  $(n - 1)$ –ESC in  $G_Q$ . Let  $A = A_1 \cup \dots \cup A_n$  be the corresponding long Möbius band and let  $a_i \in a(\sigma)$  be  $\partial A_i - \partial A_{i-1}$  for each  $i = 2, \dots, n$  and  $a_1 = \partial A_1$ . Assume that, for some  $i < j$ ,  $a_i, a_j$  cobound an annulus  $B$  in  $\hat{F}$  that is otherwise disjoint from  $K$ . Then  $j = i + 1$  and  $A_j$  cobounds a solid torus  $V$  with  $B$ . Furthermore,  $A_j$  is longitudinal in  $V$ , the interior of  $V$  is disjoint from  $K$  and  $V$  guides an isotopy of  $A_j$  to  $B$ .*

Addendum: *Let  $D$  be a meridian disk of  $H_B$  or  $H_W$  disjoint from  $K$  and  $A$ , and let  $F^*$  be  $\hat{F}$  surgered along  $D$ . If  $a_i, a_j$  cobound an annulus  $B$  of  $F^*$  (rather than  $\hat{F}$ ) that is otherwise disjoint from  $K$ , then the above conclusion is still valid (ie  $A_j = A_{i+1}$  is isotopic to  $B$ ).*

**Proof** The proof of the Addendum is the same as the proof for the Lemma, replacing  $\hat{F}$  with  $F^*$ , after noting that  $A$  can be surgered off of  $B$ . So we proceed with the proof of the Lemma.

Let  $B$  be the annulus on  $\hat{F}$  cobounded by  $a_i$  and  $a_j$  whose interior is disjoint from  $K$ . Any simple closed curves of  $A \cap B$  in the interior of  $B$  must be meridians of either  $H_B$  or  $H_W$ , and we could use such with  $A$  to create a projective plane in  $M$ . Hence we may assume  $A$  is disjoint from the interior of  $B$ . Then  $T = A_{i+1} \cup \dots \cup A_j \cup B$  is an embedded 2–torus in  $M$ .  $M$  is atoroidal, so let  $D$  be a compressing disk for  $T$ . The proof now splits into three cases depending on the relationship of  $A_{i+1}, A_j, D$  with respect to  $\hat{F}$ .

**Case I**  $A_{i+1}$  and  $A_j$  lie on opposite sides of  $\hat{F}$ .

Compressing  $T$  along  $D$  gives a sphere which bounds a ball  $B^3$  in  $M$ . If  $D$  is not contained in  $B^3$  then  $T$  bounds a solid torus to the side containing  $D$  (and  $B^3$ ). In

this situation, the unfurling move from [1, Section 4.3] applies to reduce the width of  $K$ . (Let  $V$  be the solid torus bounded by  $T$ .  $K$  intersects  $V$  as a single arc partitioned as a pair of spanning arcs  $\kappa$  and  $\kappa''$  on the annulus  $A_{i+1} \cup \dots \cup A_j$  union an arc  $\kappa'$  in  $\text{Int } V$  with its boundary on a single boundary component of this annulus. With support in a small neighborhood of  $V$ , there is an isotopy of  $K$  (which may be viewed as rotations of  $V$ ) that returns  $\kappa'$  to its original position and replaces  $\kappa, \kappa''$  by spanning arcs of  $B$  (these may be taken to be on  $B \cap \hat{F}$  for the Addendum). A further slight isotopy in a neighborhood of the new  $\kappa, \kappa''$  puts  $K$  in bridge position with respect to  $\hat{F}$  again, but with smaller bridge number (width.) Since this contradicts the presumed thinnest positioning of  $K$ ,  $D$  must be contained in  $B^3$ . On the other hand, if  $B^3$  contains  $D$  then  $T$  lies in  $B^3$ , hence  $a_i$  does also. But this contradicts Lemma 3.3.

**Case II**  $A_{i+1}$  and  $A_j$  lie on the same side of  $\hat{F}$ , and  $D$  near  $B$  lies on the opposite side of  $\hat{F}$ .

Let  $V$  be the closure of the component of  $M \setminus T$  containing  $D$ . As  $a_i$  does not lie in a 3-ball by Lemma 3.3,  $V$  is a solid torus. Isotop  $K$  into the interior of  $V$ . Since  $M$  is irreducible and not a lens space, and since the exterior of  $K$  is irreducible and atoroidal,  $K$  must be a core of  $V$ . Now  $A' = A_1 \cup \dots \cup A_i$  is a Möbius band properly embedded in  $V$ . Thus  $K$  is isotopic to the core of  $A'$ , hence of  $A_1$ . The following contradicts either that  $K$  has bridge number greater than zero with respect to  $\hat{F}$  or that  $K$  is hyperbolic.

**Claim 8.6** *The core of  $A_1$  is isotopic to a core curve of  $H_W$  or  $H_B$  or has exterior which is a Seifert fiber space over the disk with at most two exceptional fibers.*

**Proof** In SITUATION NO SCC,  $A_1$  is a properly embedded Möbius band in one of the Heegaard handlebodies. So the core of  $A_1$  is a core curve of the handlebody. So assume we are in SITUATION SCC. Then there is a meridian disk  $E$  of a Heegaard handlebody  $H$  on one side of  $\hat{F}$  that is disjoint from both  $K$  and  $Q$ . Let  $\mathcal{N}$  be the component of  $H - N(E)$  containing  $\partial A_1$ . We may isotop  $A_1$  in  $M$ , fixing  $\partial A_1$ , so that its interior is disjoint from  $\partial \mathcal{N}$ . If  $A_1 \subset \mathcal{N}$  then the core of  $A_1$  is isotopic to a core of  $H$ . Thus we assume that  $A_1$  is properly embedded in the exterior of  $\mathcal{N}$  in  $M$ . Let  $n$  be the number of times  $\partial A_1$  winds around the core of  $\mathcal{N}$ . As  $M$  contains no projective plane,  $n > 0$ . If  $n > 1$  then,  $U = N(\mathcal{N} \cup A_1)$  is a Seifert fiber space over the disk with two exceptional fibers.  $\partial U$  must compress in  $M - U$ . As  $\partial A_1$  does not lie in a 3-ball by Lemma 3.3,  $M - U$  must be a solid torus. Thus the exterior of the core of  $A_1$  is a Seifert fiber space over the disk with at most two exceptional fibers. Finally, assume  $n = 1$ . Let  $L$  be a core of  $\mathcal{N}$ . Then  $L$  is a  $(2, 1)$ -cable of the core of  $A_1$ . Claim 8.7 below shows that the core of  $A_1$ , since it is isotopic to  $K$  and therefore hyperbolic, is isotopic to a core of  $H_B$  or  $H_W$ . □

**Claim 8.7** *Let  $L$  be a cable of a hyperbolic knot  $K$  in a 3-manifold  $M \not\cong S^3$ . Assume that  $L$  is a core of  $H_B$  in a strongly irreducible genus 2 Heegaard splitting  $H_B \cup_{\widehat{F}} H_W$  of  $M$ . Then  $K$  is isotopic to a core of either  $H_B$  or  $H_W$ .*

**Proof** Let  $Y = M - N(L)$ . Let  $A$  be the cabling annulus for  $L$  considered as properly embedded in  $Y$ . Because  $K$  is hyperbolic,  $A$  is the unique essential annulus in  $Y$  up to isotopy. Let  $E$  be a nonseparating disk in  $H_B$  disjoint from  $L$ , and let  $\alpha = \partial E \subset \partial H_W$ . Then  $A$  is the unique essential annulus in  $H_W \cup N(E) = Y$ . Now  $\partial H_W - \alpha$  is incompressible in  $H_W$  by the strong irreducibility of the splitting. Apply [10, Theorem 1], where  $M = H_W$  and  $M_\alpha = Y$ . First assume [10, Theorem 1(a)] holds and let  $A'$  be the  $\alpha$ -essential annulus. By [10, Proposition C] (and the uniqueness of essential annuli in  $Y$ ),  $A'$  is isotopic to  $A$  in  $Y$ . Then  $A'$  is a separating essential annulus in  $H_W$  and consequently cobounds a solid torus  $T$  with an annulus  $A''$  on  $\partial H_W$ . As  $A''$  is disjoint from  $\partial E$ ,  $T$  is isotopic to the solid torus cobounded by  $A$  and  $\partial Y$ . Thus  $K$  can be isotoped in  $Y$  to a core of  $T$  and hence to a core of  $H_W$ . So assume [10, Theorem 1(b)] holds and let  $S$  be the essential annulus of  $Y$  described. Then again,  $S$  is isotopic to  $A$ . Furthermore, the solid torus  $T$  must be the cabling solid torus in  $Y$  whose core is  $K$ . As  $\tau_1$  described in [10, Theorem 1] is also a core of  $T$ ,  $K$  is isotopic to  $\tau_1$ . As  $\tau_1$  is a core of  $H_B$ , so is  $K$ . □

**Case III**  $A_{i+1}$  and  $A_j$  lie on the same side of  $\widehat{F}$ , and  $D$  near  $B$  lies on the same side of  $\widehat{F}$ .

Let  $V$  be the component of  $M \setminus T$  containing  $D$ . Then  $K$  may be perturbed to miss  $V$  completely. Since  $K$  cannot lie in a 3-ball (by the irreducibility of the exterior of  $K$ ),  $V$  is a solid torus.  $A' = A_1 \cup \dots \cup A_i$  is a Möbius band properly embedded in  $M - V$ . We may assume  $\partial D$  intersects  $\partial A'$  minimally on  $T$ . Let  $n$  be this intersection number. If  $n = 0$ , then we may use  $A'$  and  $D$  to construct a projective plane in  $M$ , a contradiction. If  $n = 1$  then  $B$  is longitudinal in  $V$ . If furthermore,  $j > i + 1$  then we can use  $V$  to thin  $K$  (by reducing the bridge number), a contradiction. Thus, when  $n = 1$  we have the conclusion of the Lemma.

So assume  $n > 1$ . Let  $N = N(V \cup A')$ . Then  $N$  is a Seifert fiber space over the disk with two exceptional fibers of order  $2, n$ . Lemma 8.3 now applies to give a genus 2 Heegaard splitting of  $M$  in which  $K$  is 0-bridge. This contradicts the presumed minimal bridge position of  $K$  with respect to the original splitting  $H_B \cup_{\widehat{F}} H_W$ . □

We make the following useful observation:

**Lemma 8.8** *Let  $\Gamma$  be a bridge collection of arcs in a handlebody  $H$ . Let  $A$  be an annulus or Möbius band properly embedded in  $H$  that is disjoint from  $\Gamma$ . Let  $\kappa$  be a cocore of  $A$ . Then  $\{\kappa\} \cup \Gamma$  is a bridge collection of arcs in  $H$ .*

**Proof** Let  $\mathcal{D}$  be a collection of bridge disks in  $H$  for  $\Gamma$ . If  $\mathcal{D}$  is disjoint from  $A$ , then a  $\partial$ -compressing disk of  $A$  (ie a disk intersecting  $A$  in a single arc essential in  $A$ ) can be isotoped to give a bridge disk for  $\kappa$ . We may isotope this disk to be disjoint from  $\mathcal{D}$ , thereby showing that  $\kappa \cup \Gamma$  is a bridge collection.

So we assume that  $\mathcal{D}$  can be chosen to meet  $A$  in a nonempty collection of cocores of  $A$ . An outermost arc,  $\kappa'$ , of  $A \cap \mathcal{D}$  in  $\mathcal{D}$  cuts out an outermost disk  $D$ . After perturbing  $D$  slightly,  $D$  becomes a bridge disk for  $\kappa'$  disjoint from  $\mathcal{D}$ , showing that  $\kappa' \cup \Gamma$  is a bridge collection. As  $\kappa$  is isotopic to  $\kappa'$  in  $A$ , this proves the Lemma.  $\square$

**Lemma 8.9** *Let  $A = A_1 \cup \dots \cup A_n$  be the long Möbius band corresponding to a proper ESC, and assume we are in SITUATION NO SCC. Assume, as in the conclusion of Lemma 8.5, some  $A_j$  cobounds a solid torus  $V$  with an annulus  $B$  in  $\hat{F}$ , that  $A_j$  is longitudinal in  $V$ , and the interior of  $V$  is disjoint from  $K$ . Then  $j = n$ .*

**Proof** Assume for contradiction that  $j < n$ . We use  $V$  to isotop  $A_j$  to  $B$  and then into the opposite handlebody,  $H_W$  say. Then  $A_{j-1} \cup A_j \cup A_{j+1}$  is a properly embedded, incompressible annulus or Möbius band in  $H_W$ . Lemma 8.8 shows that we can reduce the bridge number of  $K$  by replacing the arcs  $K \cap (A_{j-1} \cup A_j \cup A_{j+1})$  with the cocores of this properly embedded annulus or Möbius band.  $\square$

**Lemma 8.10** *Let  $a, a', a''$  be components of  $a(\sigma)$  for a proper ESC,  $\sigma$ . If  $a, a'$  and  $a', a''$  each cobound annuli on  $\hat{F}$  with interiors disjoint from  $K$ , then  $K$  can be thinned.*

*Addendum: Let  $D$  be a meridian disk of  $H_B$  or  $H_W$  disjoint from  $K$  and  $Q$ . Let  $F^*$  be  $\hat{F}$  surgered along  $D$ . If  $a, a'$  and  $a', a''$  each cobound annuli on  $F^*$  (rather than  $\hat{F}$ ) with interiors disjoint from  $K$ , then  $K$  can be thinned.*

**Proof** The argument for the Addendum is the same as the argument below with  $\hat{F}$  replaced by  $F^*$ .

Assume  $a, a'$  cobound an annulus  $B$  on  $\hat{F}$ , and  $a', a''$  cobound  $B'$  on  $\hat{F}$ , with  $\text{int}(B)$ ,  $\text{int}(B')$  disjoint from  $K$ . Let  $A = A_1 \cup \dots \cup A_n$  be the long Möbius band associated to  $\sigma$  and  $a_i = \partial A_i - \partial A_{i-1}$  be the components  $a(\sigma)$ . Then by Lemma 8.5 (and its Addendum for the Addendum here), we can write  $a = a_i, a' = a_{i+1}, a'' = a_{i+2}$  for some  $i$ . Furthermore,  $A_{i+1} \cup B, A_{i+2} \cup B'$  bound solid tori  $V, V'$  whose interiors are disjoint from  $K$  and which guide isotopies of  $A_{i+1}, A_{i+2}$  to  $B, B'$  (respectively). Together these define an isotopy of the arcs  $K \cap (A_{i+1} \cup A_{i+2})$  onto  $B, B'$ . We can then perturb the resulting arcs off of  $\hat{F}$ , resulting in a thinning of  $K$ .  $\square$



**Lemma 8.11**  *$M$  contains a Dyck's surface if either:*

- (1) *There are three mutually disjoint Möbius bands in  $M$ , each almost properly embedded in  $H_B$  or  $H_W$ .*
- (2) *There is a Möbius band in  $M$  almost properly embedded in either  $H_B$  or  $H_W$  whose boundary is separating on  $\hat{F}$ .*

**Proof** First assume the Möbius bands are properly embedded in the Heegaard handlebodies. Note that 3 mutually disjoint Möbius bands cannot all be properly embedded in a single genus 2 handlebody. Thus to have 3 mutually disjoint Möbius bands in  $M$  each properly embedded in either  $H_B$  or  $H_W$ , two must lie to one side of  $\hat{F}$  and one must lie to the other. Furthermore their boundaries must be in different isotopy classes on  $\hat{F}$ , else  $M$  contains an embedded Klein bottle.

If the boundary of a Möbius band that is properly embedded in either of these handlebodies has separating boundary on  $\hat{F}$ , then it divides  $\hat{F}$  into two once-punctured tori. Capping off one of these with the Möbius band produces an embedding of Dyck's surface in the handlebody, a contradiction. Thus the boundaries of these 3 Möbius bands cut  $\hat{F}$  into two thrice-punctured spheres. Capping off one of these thrice-punctured spheres with the 3 Möbius bands produces an embedding of Dyck's surface in  $M$ .

Now assume that some Möbius band is almost properly embedded. Then there is a meridian disk disjoint from all three Möbius bands. After surgering  $\hat{F}$  along this disk the hypotheses above guarantee that  $M$  contains an embedded Klein bottle or projective plane (either some Möbius band boundary becomes trivial or two become isotopic), contrary to assumption.  $\square$

**Lemma 8.12** *Assume there is an annulus,  $A$ , almost properly embedded in either  $H_B$  or  $H_W$  whose boundary components are in distinct, essential isotopy classes in  $\hat{F}$  neither of which is a meridian of either handlebody. If there is an almost properly embedded Möbius band in either handlebody that is disjoint from  $A$  and whose boundary is not isotopic on  $\hat{F}$  to either boundary component of  $A$ , then  $M$  contains a Dyck's surface.*

**Proof** Note that in fact the annulus and Möbius band are properly embedded, else the hypothesis would imply the existence of an embedded projective plane in  $M$ . Let  $A$  be the annulus and  $B$  be the Möbius band. By Lemma 8.11 we assume  $\partial B$  is not separating on  $\hat{F}$ . Since  $A$  is nonseparating and incompressible, each component of  $\partial A$  is nonseparating in  $\hat{F}$  ( $A$  is disjoint from a nonseparating meridian disk). Therefore all three components of  $\partial(A \cup B)$  are nonseparating. The complement of these three curves on  $\hat{F}$  is two copies of the thrice punctured sphere. Let one be  $P$ . Then  $P \cup A \cup B$  is an embedding of Dyck's surface in  $M$ .  $\square$



**Lemma 8.13** *Assume  $M$  does not contain a Dyck’s surface. In SITUATION NO SCC:*

- (1) *If  $G_Q$  contains a proper  $r$ -ESC then  $r \leq 2$ .*
- (2) *The long Möbius band  $A_1 \cup A_2 \cup A_3$  arising from any proper 2-ESC must have  $\partial A_2$  nonisotopic on  $\hat{F}$ ,  $\partial A_3$  cobounding an annulus  $B$  on  $\hat{F}$ .  $A_3 \cup B$  cobounds a solid torus  $V$  whose interior is disjoint from  $K$  and in which  $A_3$  is longitudinal. That is,  $V$  guides an isotopy of  $A_3$  in  $M$  to  $B$ .*

**Proof** Consider an  $(n - 1)$ -times extended Scharlemann cycle (an  $(n - 1)$ -ESC; see Section 4),  $\sigma$ , in  $G_Q$  for which  $n$  is largest and that is still proper. Let  $A = A_1 \cup A_2 \cup \dots \cup A_n$  be its associated long Möbius band. Let  $a_i = \partial A_i \cap \partial A_{i+1}$ . Assume  $A_1$  is Black so that  $A_i$  is White for  $i$  even and Black for  $i$  odd.

Assume there exists a proper 3-ESC so that  $n \geq 4$  ( $\sigma$  is maximal). Since there are at most 3 isotopy classes of mutually disjoint simple loops on  $\hat{F}$ , two curves of  $a(\sigma)$  must be isotopic. Let  $B$  be the annulus cobounded by adjacent ones.

If the interior of  $B$  is not disjoint from  $K$  then there is a vertex  $x$  of  $K \cap \text{Int } B$ . Since, by Corollary 5.4,  $\Lambda_x$  contains a bigon, there is a proper extended Scharlemann cycle,  $\nu$ , and a corresponding long Möbius band  $A^x$  whose boundary is a curve comprising two edges of  $\Lambda_x$  meeting at  $x$  and one other vertex. Therefore this curve cannot transversely intersect  $\partial B$  and thus must be contained in  $B$ . By Lemma 4.3,  $\nu, \sigma$  must have the same core labels. But this contradicts the maximality of  $\sigma$ .

Hence  $K \cap \text{Int } B = \emptyset$ . Thus by Lemma 8.5 and Lemma 8.9, since  $K$  does not lie on a genus 2 splitting of  $M$  and  $\text{Int } B \cap K = \emptyset$ ,  $\partial B = a_{n-1} \cup a_n$ . That is,  $a_{n-1}, a_n$  are the only components of  $a(\sigma)$  parallel on  $\hat{F}$ . Since  $n \geq 4$ ,  $n = 4$  and the components of  $\partial A_4, a_3$  and  $a_4$ , cobound an annulus on  $\hat{F}$ . Moreover the curves  $a_1, a_2, a_3$  are in different isotopy classes on  $\hat{F}$ . But then  $A_1$  and  $A_3$  contradict Lemma 8.12 (no  $a_i$  bounds a disk else  $M$  contains a projective plane).

Now assume there exists a 2-ESC so that  $n = 3$ . Then by Lemma 8.12 some pair of boundary components of  $A_1$  and  $A_3$  must be isotopic. Lemma 8.5, Lemma 8.9, and the argument above (now a 2-ESC is maximal) show this pair must be  $\partial A_3$  and prove part (2). □

**Lemma 8.14** *If there are 3 SCs in  $G_Q$  with disjoint label pairs then  $M$  contains a Dyck’s surface.*

**Proof** Assume there are 3 SCs with disjoint label pairs. These give rise to 3 mutually disjoint Möbius bands each almost properly embedded in either  $H_B$  or  $H_W$ . By Lemma 8.11  $M$  contains a Dyck’s surface. □

**Lemma 8.15** *No two edges may be parallel in  $G_F$  that meet a vertex at the same label.*

**Proof** Assume there were two such parallel edges in  $G_F$ . If the two vertices of  $G_F$  that these edges connect are parallel, then there must be a length 2 Scharlemann cycle in  $G_F$  which can be used to create an embedded projective plane in the meridional surgery on  $K$ ; a contradiction. If the two vertices that the parallel edges connect are antiparallel, then the argument of [16, Section 5, Case (2)], implies that  $K$  is a cable knot, contradicting that  $K$  is hyperbolic.  $\square$

**Lemma 8.16** *In SITUATION NO SCC, assume there is a White (23)–SC. Let  $A_{23}$  be its corresponding Möbius band in  $H_W$ . Then there are mutually disjoint bridge disks for all of the White arcs  $K \cap H_W$  whose interiors are also disjoint from  $A_{23}$ .*

**Proof** First take a bridge disk  $D_{23}$  for (23) disjoint from the other bridge arcs  $K \cap H_W$ . This disk may be chosen to have interior disjoint from  $A_{23}$  since otherwise there is a compression,  $\partial$ -compression, or a banding that will form a new bridge disk for (23) intersecting  $A_{23}$  fewer times.

Then  $\partial N(D_{23} \cup A_{23}) - \partial H_W$  is a separating meridian disk in  $H_W$ . Any collection of bridge disks for the remaining arcs of  $K \cap H_W$  may be pushed off this disk.  $\square$

**Lemma 8.17** *Two properly embedded, non- $\partial$ -parallel arcs in a Möbius band with the same boundary are isotopic rel  $\partial$ .*

**Proof** Let  $a$  and  $b$  be two properly embedded, non- $\partial$ -parallel arcs in a Möbius band such that  $\partial a = \partial b$ . Let  $a'$  be a push-off of the arc  $a$ . Isotopy  $b$  rel- $\partial$  to minimize both  $|a' \cap b|$  and  $|a \cap b|$ .

If  $|a' \cap b| = 0$ , then  $a$  and  $b$  are isotopic rel- $\partial$ . If  $|a' \cap b| \neq 0$  then the two arcs of  $b - a'$  sharing an end point with  $a$  either lie on the same side of  $a \cup a'$  or on different sides. If they lie on the same side, then there must be a bigon with boundary composed of an arc in  $a'$  and an arc in  $b$  with interior disjoint from  $a' \cup b$ . Thus there is an isotopy rel- $\partial$  of  $b$  to reduce  $|a' \cap b|$  contrary to assumption. If they lie on different sides, then their union must be  $b$  with  $b$  parallel into the boundary of the Möbius band. This too is contrary to assumption.  $\square$

## 9 $t < 10$

In this section we prove:

**Theorem 9.1** *Either  $M$  contains a Dyck's surface or  $t < 10$ .*

**Proof** This is Proposition 9.2 of Section 9.1 when we are in SITUATION NO SCC, and Proposition 9.8 of Section 9.2 in SITUATION SCC.  $\square$

**9.1  $t \geq 10$  and SITUATION NO SCC**

**Proposition 9.2** *In SITUATION NO SCC, either  $M$  contains a Dyck’s surface or  $t < 10$ .*

**Proof** Assume we are in SITUATION NO SCC,  $M$  does not contain a Dyck’s surface and  $t \geq 10$ . By Lemma 8.13, there are three cases to consider:

- (A) There is a 2–ESC in  $\Lambda$ .
- (B) There is an ESC in  $\Lambda$  but no 2–ESC.
- (C) There is no ESC in  $\Lambda$ .

**Case A** *There is a 2–ESC in  $\Lambda$ .*

Assume  $G_Q$  contains  $\tau$ , the 2–ESC depicted in Figure 19 (WLOG as labeled there and with Black and White as pictured). It gives rise to a long Möbius band  $A_1 \cup A_2 \cup A_3$  in which  $A_1$  is a Black Möbius band,  $A_2$  is a White annulus and  $A_3$  is a Black annulus. By Lemma 8.13 the components of  $\partial A_2$  lie in two distinct isotopy classes on  $\hat{F}$  whereas the components of  $\partial A_3$  are isotopic to each other.

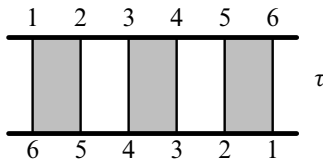

Figure 19

**Lemma 9.3** *There is no SC whose label set is disjoint from the labels  $\{2, 3, 4, 5\}$ .*

**Proof** Assume there is a SC disjoint from the labels  $\{2, 3, 4, 5\}$ . This gives rise to a Möbius band properly embedded in  $H_B$  or  $H_W$  which must be disjoint from the annulus  $A_2$ . Since  $M$  contains no Klein bottles, the boundary of this Möbius band cannot be isotopic to either component of  $\partial A_2$ . By Lemma 8.12, however, this cannot occur.  $\square$

Recall [Corollary 5.4](#), that for each label  $x$  the subgraph  $\Lambda_x \subset \Lambda$  must contain a bigon and hence an ESC or SC. By [Lemma 9.3](#), the SC in a bigon of  $\Lambda_x$  must have label pair intersecting  $\{2, 3, 4, 5\}$ , and by [Lemma 8.13](#)(1) an ESC may be at most twice extended. Thus  $x$  can be no more than 3 away from the label 2 or 5; at its furthest,  $x = t - 1$  or  $x = 8$ . Therefore  $t = 10$ .

For  $\Lambda_9$  the only possibility is a 2-ESC with labels  $\{9, 10, 1, 2, 3, 4\}$ ; it contains an SC with label pair  $\{1, 2\}$ . Similarly, for  $\Lambda_8$  the only possibility is a 2-ESC with labels  $\{3, 4, 5, 6, 7, 8\}$ ; it contains an SC with label pair  $\{5, 6\}$ . The SC in  $\tau$  has label pair  $\{3, 4\}$ . But now the existence of these three SCs with disjoint label pairs contradicts [Lemma 8.14](#). (Really this contradicts that there cannot be 3 disjoint, properly embedded Möbius bands in a genus 2 handlebody.) This completes the proof in Case A.

**Case B** *There is an ESC in  $\Lambda$  but no 2-ESC.*

Assume  $G_Q$  contains  $\tau$ , the ESC depicted in [Figure 20](#).

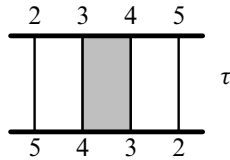

Figure 20

**Lemma 9.4** *There cannot be two ESCs whose SCs have opposite colors and for which the corresponding long Möbius bands are disjoint.*

**Proof** Assume otherwise. Let  $A_1$  and  $A_2$  be the Möbius band and annulus respectively arising from one ESC and  $B_1$  and  $B_2$  be the Möbius band and annulus respectively arising from the other. We may assume  $A_1$  and  $B_2$  are Black while  $A_2$  and  $B_1$  are White. No component of  $\partial A_2$  is isotopic on  $\hat{F}$  to a component of  $\partial B_2$  since otherwise the two long Möbius bands will form an embedded Klein bottle. Then by [Lemma 8.12](#) the components of  $\partial A_2$  must be isotopic as must the components of  $\partial B_2$ . By [Lemma 8.5](#),  $A_2$  and  $B_2$  are parallel into  $\hat{F}$  (note that since these ESCs are of maximal length, we may apply the argument of [Lemma 8.13](#) to show that the annuli on  $\hat{F}$  between the components of  $\partial A_2$  and  $\partial B_2$  respectively must be disjoint from  $K$ ). These two parallelisms however give a thinning of  $K$ . This is a contradiction.  $\square$

We now consider the possible bigons of  $\Lambda_7$  and  $\Lambda_9$ . The possibilities are shown in [Figure 21](#). [Lemma 9.4](#) immediately rules out 7(d).

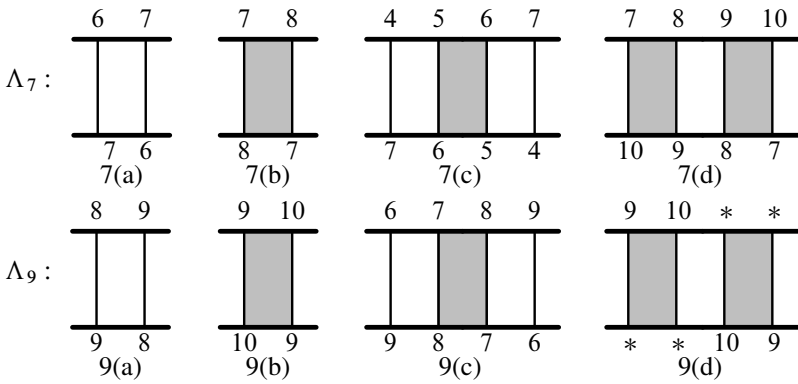

Figure 21

**Claim 9.5**  $9(c)$  is impossible.

**Proof** Consider the bigons of  $\Lambda_1$ . The four possibilities are listed in Figure 22. With  $\tau$  and  $9(c)$ , each of 1(a), 1(b) and 1(c) contradict Lemma 8.14. Together  $9(c)$  and 1(d) contradict Lemma 9.4.  $\square$

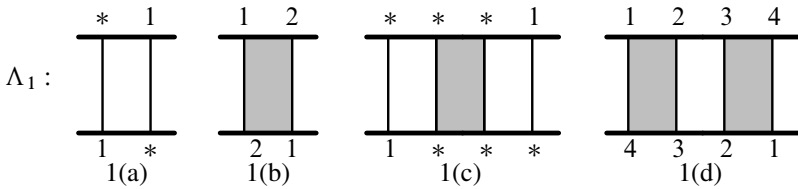

Figure 22

**Claim 9.6**  $7(a)$  and  $7(c)$  are impossible.

**Proof** With  $\tau$  and  $7(a)$ , each of  $9(a)$ ,  $9(b)$  and  $9(d)$  (the remaining possible bigons of  $\Lambda_9$ ) contradict Lemma 8.14. Similarly with  $\tau$  and  $7(c)$ , each of  $9(a)$ ,  $9(b)$  and  $9(d)$  contradict Lemma 8.14.  $\square$

**Claim 9.7**  $7(b)$  is impossible.

**Proof** With  $\tau$  and  $7(b)$ , each of  $9(b)$  and  $9(d)$  contradict Lemma 8.14. Therefore we must have  $9(a)$ . Hence we have SCs with label pairs  $\{3, 4\}$ ,  $\{7, 8\}$  and  $\{8, 9\}$ . Again,  $\Lambda_1$  must have one of the bigons listed in Figure 22. Each of the SCs contained within 1(a), 1(b) and 1(c) form, along with two of those with labels pairs  $\{3, 4\}$ ,  $\{7, 8\}$  and  $\{8, 9\}$ , a triple of mutually disjoint SCs. This contradicts Lemma 8.14.

So we assume we have 1(d) along with  $\tau$ , 7(b) and 9(a). The possible bigons of  $\Lambda_6$  are 7(a), 9(c), an SC on labels  $\{5, 6\}$  and a 1-ESC on labels  $\{3, 4, 5, 6\}$ . The first two have already been ruled out. Each of the two remaining gives rise to an SC that joins with those above to contradict [Lemma 8.14](#).  $\square$

This completes the proof in Case B.

**Case C** *There is no ESC in  $\Lambda$ .*

In this case every label belongs to an SC. [Lemma 8.14](#) then forces  $t \leq 6$  contrary to the assumed  $t \geq 10$ . This completes the proof in Case C and thus the proof of [Proposition 9.2](#).  $\square$

## 9.2 $t \geq 10$ and SITUATION SCC

**Proposition 9.8** *In SITUATION SCC, either  $M$  contains a Dyck's surface or  $t < 10$ .*

**Proof** Assume we are in SITUATION SCC. Then there is a meridian disk  $D$  of  $H_W$  or  $H_B$  disjoint from  $K$  and  $Q$ . Let  $F^*$  be  $\hat{F}$  surgered along  $D$ . Then  $F^*$  is one or two tori. For contradiction, assume  $M$  does not contain a Dyck's surface, and  $t \geq 10$ .

**Lemma 9.9** *If  $G_Q$  contains an  $r$ -ESC then  $r \leq 3$ .*

**Proof** Let  $r$  be the largest value such  $G_Q$  contains a proper  $r$ -ESC,  $\sigma$ . Assume for contradiction,  $r \geq 4$ . Then  $|a(\sigma)| \geq 5$  and there must be at least three components of  $a(\sigma)$  that are isotopic on  $F^*$ . Let  $B$  be an annulus between two components of  $a(\sigma)$  on  $F^*$  whose interior is disjoint from  $a(\sigma)$ . Any vertex of  $G_F$  in  $\text{Int } B$  must belong to a component,  $a$ , of  $a(\tau)$  for some  $r'$ -ESC,  $\tau$ , of  $\Lambda$ . Since  $a$  intersects  $a(\sigma)$  at most once, it must lie in  $B$  and ([Lemma 4.2](#)) be isotopic to the components  $\partial B$  of  $a(\sigma)$ . But this would contradict the Addendum to [Lemma 4.3](#) and the maximality of  $r$ . Thus  $\text{Int } B$  must be disjoint from  $K$ . That is, there are components  $a_1, a_2, a_3$  of  $a(\sigma)$  such that  $a_1, a_2$  and  $a_2, a_3$  cobound annuli in  $F^*$  whose interiors are disjoint from  $K$ . This contradicts the Addendum to [Lemma 8.10](#).  $\square$

**Lemma 9.10**  *$G_Q$  contains no 3-ESC.*

**Proof** Suppose  $\sigma$  is a 3-ESC. As argued in the preceding lemma, the Addendum to [Lemma 4.3](#) and the maximality of  $\sigma$  show that if  $B$  is an annulus of  $F^*$  cobounded by components of  $a(\sigma)$  such that  $\text{Int } B$  is disjoint from  $a(\sigma)$ , then  $\text{Int } B$  must be disjoint from  $K$ . Then the Addendum to [Lemma 8.10](#) shows that at most two components of  $a(\sigma)$  are isotopic on  $F^*$ . Since  $|a(\sigma)| = 4$ ,  $F^*$  must be two tori with exactly two components of  $a(\sigma)$  on each. But the argument above then says that every vertex of  $G_F$  must lie on  $a(\sigma)$ , contradicting that  $t \geq 10$ .  $\square$

**Lemma 9.11** *There is no 2-ESC.*

**Proof** Let  $\sigma$  be a 2-ESC. The argument of Lemma 9.10 coupled with its conclusion that there is no 3-ESC, implies that  $F^*$  must consist of two tori:  $T_1$  containing two components of  $a(\sigma)$  and  $T_2$  containing one. Again, the argument of Lemma 9.10, shows that the only vertices of  $G_F$  on  $T_1$  are those lying on the two components of  $a(\sigma)$ .

Assume  $\sigma$  is given by Figure 19. By Corollary 5.4 there is a bigon of  $\Lambda_8$ . This can be taken to be a proper  $r$ -ESC,  $\tau$  (where  $r = 0$  means an SC). Then  $r \leq 2$ . By the Addendum to Lemma 4.3, each component of  $a(\tau)$  must intersect a component of  $a(\sigma)$ . Enumerating the possibilities for the labels of  $\tau$  consistent with these conditions we have:

- (a)  $\{5, 6, 7, 8\}$
- (b)  $\{8, 9, 10, 1, 2, 3\}$
- (c)  $\{3, 4, 5, 6, 7, 8\}$

But (a) is not possible as vertices 7, 8 of  $G_F$  must lie on  $T_2$ , but the corresponding components of  $a(\tau)$  intersect two different components of  $a(\sigma)$ . The same argument with vertices 8, 9 rules out (b). So we assume the labels of  $\tau$  are given by (c). Since vertices 7, 8 of  $G_F$  lie in  $T_2$ , then vertices 3, 4 must also lie in  $T_2$  while vertices 1, 2, 5, 6 must be those in  $T_1$ .

Now take a bigon of  $\Lambda_{10}$  giving a proper  $n$ -ESC,  $\nu$ . By the Addendum to Lemma 4.3, as argued above, each component of  $a(\nu)$  must intersect both  $a(\sigma)$  and  $a(\tau)$ . Furthermore,  $n \leq 2$ . These conditions guarantee that the label set for  $\nu$  is  $\{10, 1, 2, 3, 4, 5\}$ . But this contradicts that vertex 2 lies on  $T_1$  and vertex 3 on  $T_2$ . □

**Lemma 9.12** *There is no 1-ESC.*

**Proof** Assume there is an ESC,  $\sigma$ , on the labels  $\{1, 2, 3, 4\}$ . By Corollary 5.4, there is a proper  $r$ -ESC,  $\tau$ , coming from a bigon of  $\Lambda_5$ , and a proper  $n$ -ESC,  $\nu$ , coming from a bigon of  $\Lambda_9$ . Furthermore,  $0 \leq r, n \leq 1$ . A simple enumeration shows the possible label pairs of the core SC for  $\tau$  are:  $\{34, 45, 56, 67\}$ . The possible labels for the core SC of  $\nu$  are:  $\{78, 89, 910, 10*\}$  (where the label  $*$  means either 1 or 11). Three SCs on disjoint label pairs would allow us to use  $F^*$  to form a Klein bottle in  $M$ . Thus the label pairs of the core SCs of two of  $\{\sigma, \tau, \nu\}$  must intersect. The possibilities are:

- (a)  $\sigma, \tau$ , where  $\tau$  has label set  $\{2, 3, 4, 5\}$ .
- (b)  $\tau, \nu$ , where  $\tau$  has label set  $\{5, 6, 7, 8\}$  and  $\nu$  has label set  $\{6, 7, 8, 9\}$ .

Both lead to the same contradiction. We consider (b). The edges of  $\tau, \nu$  force the vertices 5, 6, 7, 8, 9 to lie on the same torus component of  $F^*$ . There is a component of  $a(\tau)$  disjoint from a component of  $a(\nu)$ . Hence these components are isotopic on  $F^*$ . But this contradicts the Addendum to [Lemma 4.3](#).  $\square$

The preceding lemmas, along with [Corollary 5.4](#), imply that every label of  $\Lambda$  belongs to an SC. But then [Lemma 8.14](#) along with the assumption that  $t \geq 10$  implies that  $M$  contains a Dyck's surface. This contradiction concludes the proof of [Proposition 9.8](#).  $\square$

## 10 $t < 8$

By [Theorem 9.1](#),  $t \leq 8$ . In this section we prove:

**Theorem 10.1** *Either  $M$  contains a Dyck's surface or  $t < 8$ .*

**Proof** This is [Proposition 10.2](#) of [Section 10.1](#) when we are in SITUATION NO SCC, and [Proposition 10.17](#) of [Section 10.3](#) in SITUATION SCC.  $\square$

### 10.1 $t = 8$ and SITUATION NO SCC

**Proposition 10.2** *In SITUATION NO SCC, either  $M$  contains a Dyck's surface or  $t < 8$ .*

**Proof** Assume  $M$  does not contain a Dyck's surface and  $t = 8$ . By [Lemma 8.13](#), there are three cases to consider:

- (A) There is a 2-ESC in  $\Lambda$ .
- (B) There is a 1-ESC in  $\Lambda$  but no 2-ESC.
- (C) There is no ESC in  $\Lambda$ .

The proof in Case B relies upon [Corollary 10.16](#) and [Proposition 10.27](#) which are proven in subsections following the present proof.

**Case A** *There is a 2-ESC in  $\Lambda$ .*

As in Case A of [Theorem 9.1](#), assume  $G_Q$  contains  $\tau$ , the 2-ESC depicted in [Figure 19](#). It gives rise to a long Möbius band  $A_\tau = A_1 \cup A_2 \cup A_3$  in which  $A_1$  is a Black Möbius band,  $A_2$  is a White annulus and  $A_3$  is a Black annulus. By [Lemma 8.13](#) the components of  $\partial A_2$  are not isotopic on  $\hat{F}$  whereas the components of  $\partial A_3$  are.

[Figure 23](#) lists all possible bigons of  $\Lambda_7$  that are at most 2-ESCs (ie containing at most 6 edges). We proceed to rule out all of these bigons, thereby contradicting [Corollary 5.4](#).



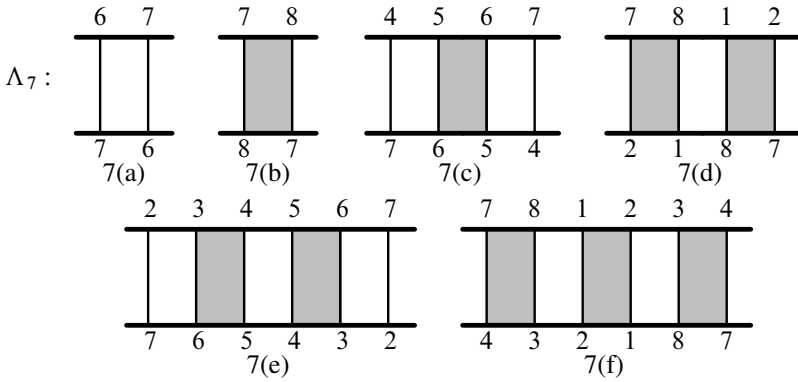

Figure 23

**Claim 10.3** 7(a), 7(b) and 7(d) are impossible.

**Proof** Each of these bigons contain an SC whose associated Möbius band is disjoint from  $A_2$ . The boundary of such a Möbius band must not be isotopic to a component of  $\partial A_2$ , else there would be an embedded Klein bottle in  $M$ . This contradicts Lemma 8.12. □

**Claim 10.4** 7(c) and 7(f) are impossible.

**Proof** Each 7(c) and 7(f) contain an SC whose associated Möbius band  $B$  intersects  $A_3$  along a component of  $A_3 \cap K$ . Because  $A_3$  is separating in the Black side of  $\hat{F}$ , the intersection of  $B$  with  $A_3$  is not transverse. Therefore the Möbius band  $B$  may be isotoped in  $H_B$  to be disjoint from  $A_3$  and hence  $A_2$ . Since  $\partial B$  cannot be isotopic on  $\hat{F}$  to either component of  $\partial A_2$ , together  $B$  and  $A_2$  form a contradiction to Lemma 8.12. □

**Claim 10.5** 7(e) is impossible.

**Proof** Figure 24 lists all possible bigons of  $\Lambda_8$  that are at most 2-ESCs. Analogously to Claims 10.3 and 10.4, we may rule out all but 8(e). Yet now 7(e) and 8(e) cannot coexist as the proof of Claim 10.4 applies analogously with 7(e) and 8(e) in lieu of 7(c) and  $\tau$  respectively. □

This completes the proof in Case A.

**Case B** There is a 1-ESC in  $\Lambda$  but no 2-ESC.

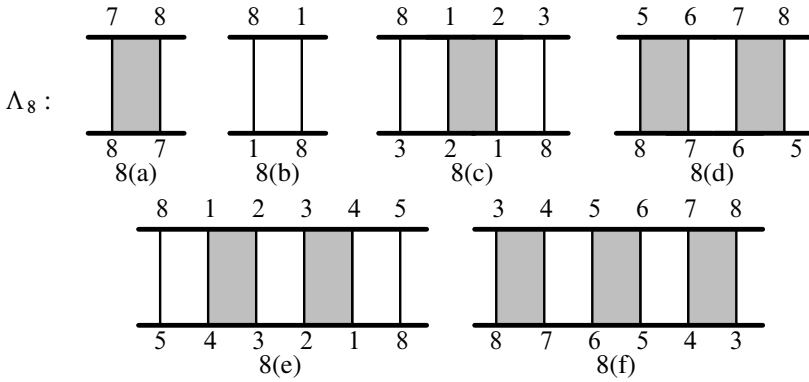

Figure 24

Assume  $G_Q$  contains  $\tau$ , the ESC depicted in Figure 20.

**Lemma 10.6** *There cannot be two 1-ESCs whose label sets intersect in one label.*

**Proof** Assume otherwise. Then their SCs have opposite colors. Let  $A_1$  and  $A_2$  be the Möbius band and annulus arising from one ESC; let  $B_1$  and  $B_2$  be the Möbius band and annulus arising from the other. Since  $A_1$  and  $B_1$  are on opposite sides, so are  $A_2$  and  $B_2$ .

By Lemma 8.12 some pair of curves of  $\partial A_1 \cup \partial B_2$  must be isotopic as must some pair of curves of  $\partial B_1 \cup \partial A_2$ . Since we may not form any embedded Klein bottles, the two components of  $\partial B_2$  must be isotopic as must the two components of  $\partial A_2$ . Then by Lemma 8.5 it follows that  $A_2$  and  $B_2$  are each parallel into  $\hat{F}$ . (The ESCs are of maximum length, so the argument of Lemma 8.13 shows that the parallelism between, say,  $\partial A_2$  is disjoint from  $K$ .)

By assumption,  $\partial A_2$  and  $\partial B_2$  intersect in one point, and thus this intersection is not transverse. Hence, as with Lemma 9.4, the parallelisms of  $A_2$  and  $B_2$  into  $\hat{F}$  give a thinning of  $K$ . This is a contradiction.  $\square$

Let us now consider the possible ESCs, SCs coming from bigons of  $\Lambda_8$  and  $\Lambda_7$ . These possibilities are shown in Figure 25.

**Claim 10.7** *Neither 7(d) nor 8(d) may occur.*

**Proof** Since each of these shares one label with  $\tau$ , Lemma 10.6 rules them out.  $\square$

**Claim 10.8** *Neither 7(c) nor 8(c) may occur.*

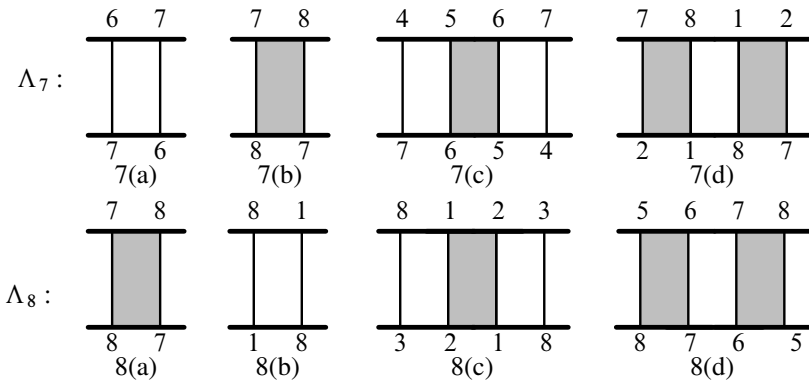

Figure 25

**Proof** Since 7(c) and 8(c) have disjoint labels, by Proposition 10.27 at most one may occur. Assume 7(c) does occur. Then either 8(a) or 8(b) must also occur (because 8(d) cannot by the preceding Claim). But then there will be three disjoint SCs contradicting Lemma 8.14. A similar argument shows 8(c) cannot occur.  $\square$

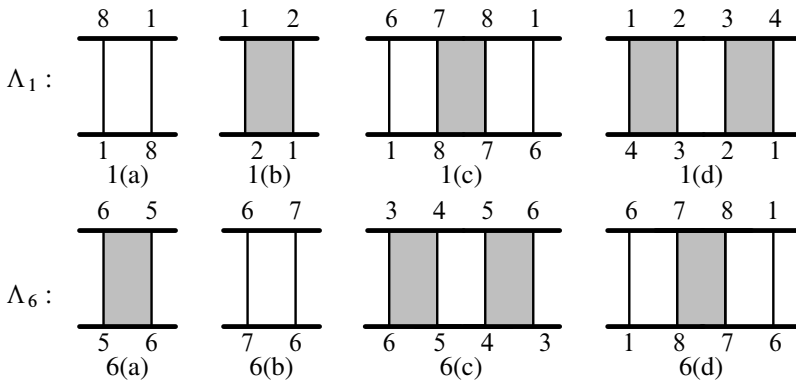

Figure 26

Figure 26 shows the possible ESCs, SCs coming from bigons of  $\Lambda_1$  and  $\Lambda_6$ . These will be of use in the next two claims.

**Claim 10.9** Neither 7(a) nor 8(b) may occur.

**Proof** Assume 7(a) occurs. With 7(a) and the SC in  $\tau$ , each of 1(a) and 1(b) form a triple of disjoint SCs contradicting Lemma 8.14. 1(c) violates Proposition 10.27. Therefore 1(d) must occur.

With relabeling (subtracting 1 from each label), we may now apply [Corollary 10.16](#) to show that there is another genus 2 Heegaard splitting of  $M$  with respect to which  $K$  is 3-bridge. (The SC in 1(d) plays the role of  $\sigma$ ,  $\tau$  is again  $\tau$  and 7(a) is the SC disjoint from the labels  $\{2, 3, 4\}$ .) This contradicts our minimality assumptions (3-bridge means  $t = 6$ ).

A similar argument rules out 8(b), using  $\Lambda_6$  in place of  $\Lambda_1$ . □

**Claim 10.10**  $\Lambda$  does not contain a (78)-SC.

**Proof** Assume there is a (78)-SC ie 7(b) and 8(a) occur. By [Proposition 10.27](#), this SC cannot be contained within an ESC. We must consider the bigons of  $\Lambda_1$  and  $\Lambda_6$  shown in [Figure 26](#).

[Proposition 10.27](#) rules out 1(c) and 6(d). [Corollary 10.16](#) rules out 1(d) and 6(c) as in the proof of [Claim 10.9](#). [Lemma 8.14](#) forbids each of 1(b) and 6(a) as they are SCs each disjoint from the SC in  $\tau$  and the (78)-SC.

Thus 1(a) and 6(b) must occur. But then 1(a), 6(b) and the SC in  $\tau$  form 3 mutually disjoint SCs in violation of [Lemma 8.14](#). □

The above claims imply that all bigons of  $\Lambda_8$  are forbidden, contradicting [Corollary 5.4](#). This completes the proof of [Theorem 10.1](#) in Case B.

**Case C** *There is no 1-ESC in  $\Lambda$ .*

By [Corollary 5.4](#), every label belongs to an SC. [Lemma 8.14](#) then forces  $t \leq 6$  contrary to the assumption that  $t = 8$ . This completes the proof in Case C.

Given the proofs of [Corollary 10.16](#) and [Proposition 10.27](#) in subsequent subsections, the proof of [Theorem 10.1](#) is now complete. □

## 10.2 A proposition and a corollary for [Claim 10.9](#)

For [Claim 10.9](#) and [Claim 10.10](#) above we use [Corollary 10.16](#) which is a consequence of [Proposition 10.11](#). In this subsection we prove the proposition and its corollary.

**Proposition 10.11** *Assume we are in SITUATION NO SCC and there exists an ESC  $\tau$  and SC  $\sigma$  as in [Figure 27](#). Let  $A_{23}$  be the White Möbius band arising from the SC in  $\tau$ , and let  $A_{12}$  be the Black Möbius band arising from  $\sigma$ . If  $\partial A_{23}$  intersects  $\partial A_{12}$  transversely on  $\widehat{F}$  then there is a new Heegaard splitting of  $M$  in which  $K$  is 3-bridge.*

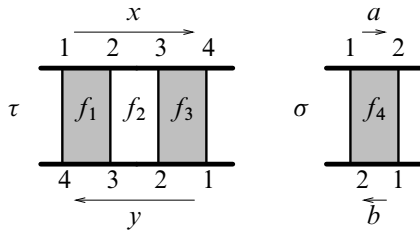

Figure 27

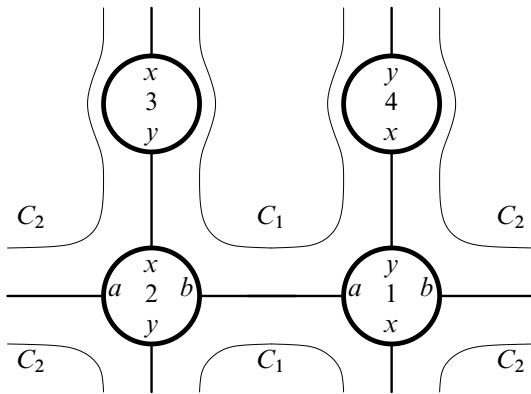

Figure 28

**Proof** Let  $A_{12,34}$  be the Black annulus arising from  $\tau$  that extends  $A_{23}$ . We assume  $\partial A_{23}$  intersects  $\partial A_{12}$  transversely. Let  $E$  be a neighborhood in  $\widehat{F}$  of the union of the vertices  $\{1, 2, 3, 4\}$  and the edges of  $\sigma, \tau$ . The labeling of these edges on  $\widehat{F}$  must be as in Figure 28. Let  $A$  be  $\widehat{F} - E$ .

**Claim 10.12**  $A$  is an annulus in  $\widehat{F}$ .

**Proof** Let  $C_1$  and  $C_2$  be the two curves on  $\widehat{F}$  as shown that form  $\partial E = \partial A$ . Since  $\chi(E) = -2 = \chi(\widehat{F})$ , we have  $\chi(A) = 0$ . If either  $C_1$  or  $C_2$  were to bound a disk in the complement of  $E$ , then such a disk could be joined to itself across an edge of  $f_4$  to form an annulus in  $\widehat{F}$ . Then this resulting annulus together with the annulus  $A_{12,34}$  would form an embedded Klein bottle. This cannot occur. Hence  $A$  is an annulus.  $\square$

Let  $\mathcal{N} = N(A_{12} \cup A_{12,34}) \subset H_B$ . Then  $\partial H_B - \mathcal{N} = A$  and set  $H_B - \mathcal{N} = \mathcal{T}$ .

**Claim 10.13**  $\mathcal{T}$  is a solid torus and the annulus  $A$  is longitudinal on  $\partial \mathcal{T}$ .

**Proof** Consider  $\mathcal{D}$ , a disjoint collection of bridge disks for  $K \cap H_B$ . By considering the intersections of these disks with the faces  $f_1, f_3, f_4$ , surgering along outermost arcs of intersection in  $\mathcal{D}$ , and banding along  $f_1, f_3, f_4$ , we can take the bridge disks  $D_{12}, D_{34}$  for (12),(34) to have interiors disjoint from  $A_{12} \cup A_{12,34}$ . Hence  $H_B - \mathcal{N} = \mathcal{T}$  is a solid torus in which  $A$  is longitudinal.  $\square$

By Claim 10.13,  $\mathcal{N}$  is isotopic to  $H_B$  through  $\mathcal{T}$ .

**Claim 10.14** *The arcs (12), (34), (56) and (78) in  $H_B$  have mutually disjoint bridge disks that lie in  $\mathcal{T}$  and provide an isotopy of these arcs onto  $A$ .*

**Proof** The above proof of Claim 10.13 shows that there are bridge disks  $D_{12}$  and  $D_{34}$  for (12) and (34) respectively, disjoint from the other arcs of  $K \cap H_B$ , which lie in  $\mathcal{T}$  and provide an isotopy of these arcs onto  $A$ . Indeed these are meridional disks of  $\mathcal{T}$ . Since bridge disks  $D_{56}$  and  $D_{78}$  for the other two arcs (56) and (78) are disjoint from  $D_{12}$  and  $D_{34}$ , the arcs of  $(D_{56} \cup D_{78}) \cap (\partial\mathcal{T} - \text{Int } A)$  may be either isotoped along  $\partial\mathcal{T} - \text{Int } A - (D_{12} \cup D_{34})$  onto  $A$  or banded to  $D_{12}$  or  $D_{34}$  to form bridge disks for (56) and (78) as desired.  $\square$

Attach a neighborhood of the White Möbius band  $A_{23}$  in  $H_W$  to  $H_B = \mathcal{N} \cup \mathcal{T}$ . Write  $\mathcal{N}' = H_B \cup N(A_{23}) = N(A_{12} \cup A_{12,34} \cup A_{23}) \cup \mathcal{T}$  and  $\widehat{F}' = \partial\mathcal{N}'$ .

**Claim 10.15**  *$M = \mathcal{N}' \cup_{\widehat{F}'} (M \setminus \mathcal{N}')$  is a genus 2 Heegaard splitting.*

**Proof** We must show that  $\mathcal{N}'$  and  $M \setminus \mathcal{N}'$  are each genus 2 handlebodies.

To see that  $\mathcal{N}'$  is a genus 2 handlebody, we show that the curve  $\partial A_{23}$  on  $\widehat{F}$  is primitive in  $H_B$ . It suffices to show that  $\partial A_{23}$  is primitive in  $\mathcal{N}$  since  $A_{23}$  is disjoint from  $\mathcal{T}$  and  $\mathcal{T}$  provides an isotopy of  $\mathcal{N}$  to all of  $H_B$ .

In  $\mathcal{N}$  a cocore of the annulus  $A_{12,34}$  (such as the arc (34)) thickens to a meridian disk of  $\mathcal{N}$  and thus extends through  $\mathcal{T}$  to a meridian disk  $D$  of  $H_B$ . Since  $\partial A_{23}$  is a component of  $\partial A_{12,34}$ , it intersects  $D$  once. Hence  $\partial A_{23}$  is primitive in  $H_B$  and  $\mathcal{N}'$  is a genus 2 handlebody.

To see that  $M \setminus \mathcal{N}'$  is a genus 2 handlebody, observe that it is the complement of a neighborhood of a Möbius band in  $H_W$ .  $\square$

To complete the proof of Proposition 10.11 we must show that  $K$  is 3-bridge with respect to the Heegaard splitting  $M = \mathcal{N}' \cup_{\widehat{F}'} (M \setminus \mathcal{N}')$ .

**Claim 10.14** shows that the arcs (56) and (78) are bridge in  $\mathcal{N}'$ . As  $(1234) = (12) \cup (23) \cup (34)$  is a cocore of the properly embedded Möbius band  $A_{12,34} \cup A_{23}$  in the handlebody  $\mathcal{N}'$ , it is bridge as well.

By **Lemma 8.16**, the arcs (45), (67) and (81) have mutually disjoint bridge disks in  $H_W$  that are also disjoint from  $A_{23}$ . Therefore they remain bridge in  $H_W - N(A_{23})$ , which is isotopic to  $M \setminus \mathcal{N}'$ .

Hence  $K$  is 3–bridge with respect to this new Heegaard splitting. □

**Corollary 10.16** *Assume we are in SITUATION NO SCC. If there is an ESC  $\tau$  and an SC  $\sigma$  as in **Figure 27** as well as an SC disjoint from the labels  $\{1, 2, 3\}$  then  $K$  is 3–bridge with respect to some genus 2 Heegaard splitting of  $M$ .*

**Proof** Given such a set-up, the boundaries of the Möbius bands arising from the SCs in  $\tau$  and  $\sigma$  cannot be isotoped to be disjoint. Otherwise there would be three disjoint Möbius bands contrary to **Lemma 8.14**. **Proposition 10.11** now applies. □

### 10.3 $t = 8$ and SITUATION SCC

**Proposition 10.17** *In SITUATION SCC, either  $M$  contains a Dyck’s surface or  $t < 8$ .*

**Proof** Assume we are in SITUATION SCC. Then there is a meridian disk  $D$  of  $H_W$  or  $H_B$  disjoint from  $K$  and  $Q$ . Let  $F^*$  be  $\hat{F}$  surgered along  $D$ . Then  $F^*$  is one or two tori. For contradiction, assume  $M$  does not contain a Dyck’s surface, and  $t = 8$ .

**Lemma 10.18**  *$G_Q$  contains no 3–ESC.*

**Proof** Otherwise, there is a 3–ESC,  $\sigma$ . Note that this is a maximal proper ESC when  $t = 8$ . Thus the argument of **Lemma 9.10** shows that  $F^*$  must be two tori,  $T_1, T_2$ , with exactly two components of  $a(\sigma)$  on each. WLOG assume the core SC of  $\sigma$  is a (45)–SC. Let  $A = A_1 \cup \dots \cup A_4$  be the long Möbius band associated to  $\sigma$  and  $a_i \in a(\sigma)$  be  $\partial A_i - \partial A_{i-1}$ . By the Addendum to **Lemma 8.5** isotopic components of  $a(\sigma)$  on  $F^*$  must be consecutive in  $A$ . Thus we may take  $a_1, a_2$  in  $T_1$  and  $a_3, a_4$  in  $T_2$ . That is, vertices  $\{3, 4, 5, 6\}$  of  $G_Q$  lie on  $T_1$  and vertices  $\{1, 2, 7, 8\}$  on  $T_2$ . Recall that  $D$  is the meridian disk along which  $\hat{F}$  is surgered to get  $T_1 \cup T_2$ . Because  $D$  is disjoint from  $K$ , vertex 3 lies on  $T_1$ , and vertex 2 lies on  $T_2$ ,  $D$  must lie on the opposite side of  $\hat{F}$  to the (23)–arc of  $K$ . Taking (23) to lie in  $H_W$ ,  $D$  must lie in  $H_B$ . Let  $\mathcal{N} = H_B - N(D) = \mathcal{N}_1 \cup \mathcal{N}_2$ , where  $\mathcal{N}_1, \mathcal{N}_2$  are solid tori with  $\partial \mathcal{N}_j = T_j$ . Since the components of  $a(\sigma)$  cannot bound disks in either handlebody, the  $A_i$  of the long Möbius band meet  $F^*$  in their interiors in simple closed curves which are trivial

on  $F^*$ . We surger along these curves to make the  $A_i$  properly embedded in either  $\mathcal{N}$  or  $M - \text{Int}\mathcal{N}$ . By the separation of  $a(\sigma)$  in  $T_1, T_2$ ,  $A_1, A_3$  lie in the exterior of  $\mathcal{N}$ ,  $A_2$  lies in  $\mathcal{N}_1$  and  $A_4$  in  $\mathcal{N}_2$ .

**Claim 10.19**  $A_{2i}$  is a longitudinal annulus in  $\mathcal{N}_i$  for  $i = 1, 2$ .

**Proof** Assume not. Then  $U = N(\mathcal{N} \cup A_1 \cup A_3)$  is a Seifert fiber space over the disk with two or three exceptional fibers (the core of  $A_1$  being one). Furthermore  $K \cap U$  lies as a cocore in the Möbius band  $A = A_1 \cup A_2 \cup A_3 \cup A_4$  properly embedded in  $U$ , where  $\partial A$  is a Seifert fiber of  $U$ .

In fact  $U$  must be Seifert fibered with exactly two exceptional fibers. Otherwise,  $V = U - N(A)$  would be a Seifert fiber space over the disk with two exceptional fibers that is disjoint from  $K$ . As  $V$  does not lie in a 3–ball by Lemma 3.3 and the exterior of  $K$  is irreducible and atoroidal, then  $V$  would be isotopic to the exterior of  $K$ , contradicting that  $K$  is hyperbolic.

Now Lemma 8.3 applies to give a genus 2 Heegaard splitting of  $M$  in which  $K$  is 0–bridge, a contradiction. □

Let  $U = N(\mathcal{N} \cup A_1 \cup A_3)$ . Then  $K \cap U$  lies as a cocore in the Möbius band  $A = A_1 \cup A_2 \cup A_3 \cup A_4$  properly embedded in  $U$ . The preceding Lemma means that  $U$  is a solid torus, and hence that  $K \cap U$  is isotopic onto  $\partial U$  fixing its endpoints. Let  $W$  be the genus 2 handlebody  $U \cup N(K)$ . Then  $K$  is isotopic onto  $\partial W$ .

**Claim 10.20** An edge of a Black bigon of  $\Lambda$  is parallel in  $T_1$  or  $T_2$  to an edge of  $\sigma$ .

**Proof** Let  $\tau$  be a black bigon with a (12)–corner. The argument for the other black corners is similar.

Assume  $\tau$  is a  $SC$ . Let  $A'$  be the almost properly embedded Möbius band corresponding to  $\tau$ . After surgery along trivial disks in  $T_2$ , we may take  $A'$  to be properly embedded in  $\mathcal{N}_2$ . Consider the annulus  $A_4$  in  $\mathcal{N}_2$  and the edges of  $\sigma$  in  $T_2$  lying in  $\partial A_4$ . Using the fact that  $\mathcal{N}_2$  contains no Klein bottle, a close look at the labeling of the edges of  $\sigma$  and  $\tau$  on  $T_2$  shows that  $\partial A'$  can be perturbed to be disjoint from  $\partial A_4$ . But this contradicts that  $\partial A_4$  is longitudinal in  $\mathcal{N}_2$ .

So  $\tau$  is not a  $SC$ . As the edges of  $G_F$  lie in either  $T_1$  or  $T_2$ , the edges of  $\tau$  must be a  $\overline{27}$ –edge and an  $\overline{81}$ –edge. Looking at the edges of  $\sigma$  in  $T_2$ , we see the edges of  $\tau$  must be parallel to these. □

**Claim 10.21** There is no bigon in  $\Lambda$  with an (81)–corner.



**Proof** Let  $\tau$  be such a bigon. An edge of  $\tau$  must lie in  $T_2$ , implying that  $\tau$  is an (81)–SC. But then the corresponding almost properly embedded Möbius band could be surgered to produce a properly embedded Möbius band in the complement of  $\mathcal{N}$  whose boundary was parallel to  $\partial A_4$  on  $T_2$ . Along with  $A$  we would see a Klein bottle in  $M$ .  $\square$

By Lemmas 5.10 and 5.13, there is a special vertex  $v$  in  $\Lambda$  of type  $[8\Delta-5]$  (Claim 10.21 implies there can be no more than eight consecutive bigons in  $\Lambda$ ). This means that all but five corners at  $v$  belong to bigons of  $\Lambda$ . By Claim 10.21, no (81)–corner belongs to a bigon of  $\Lambda$ . So there must be a black corner, say (12), such that every (12)–corner at  $v$  belongs to a bigon of  $\Lambda$ . By Claim 10.20, the edges of these bigons incident to  $v$  at label 2 must be  $\overline{27}$ –edges parallel in  $T_2$  to the edges of  $\sigma$ . In particular, there are two parallel edges in  $T_2$  both incident to vertex 2 in  $T_2$  with label  $v$ . This contradicts Lemma 12.15.  $\square$

To finish the proof of Proposition 10.17, we now follow the outline of the proof of Proposition 10.2, indicating the necessary modifications.

By Lemma 10.18, there are three cases to consider:

- (A) There is a 2–ESC in  $\Lambda$ .
- (B) There is a 1–ESC in  $\Lambda$  but no 2–ESC.
- (C) There is no ESC in  $\Lambda$ .

**Case A** *There is a 2–ESC in  $\Lambda$ .*

Assume  $G_Q$  contains  $\tau$ , the 2–ESC depicted in Figure 19. It gives rise to a long Möbius band  $A_\tau = A_1 \cup A_2 \cup A_3$  in which  $A_1$  is, say, a Black Möbius band,  $A_2$  is a White annulus and  $A_3$  is a Black annulus (each almost properly embedded in  $H_W$  or  $H_B$ ). As argued in Lemma 9.11,  $F^*$  consists of two tori  $T_1$  containing two components of  $a(\tau)$  and  $T_2$  containing one. Furthermore, the only vertices of  $G_F$  on  $T_1$  must be those lying on the two components of  $a(\tau)$ ; the other four are on  $T_2$ . Finally, by the Addendum of Lemma 8.5, components of  $a(\tau)$  that are isotopic on  $F^*$  must cobound some  $A_i$ . Thus the vertices of  $G_F$  on  $T_1$  are either

- (i)  $\{1, 2, 5, 6\}$       or      (ii)  $\{2, 3, 4, 5\}$ .

Figure 23 lists all possible bigons of  $\Lambda_7$  that are at most 2–ESCs (ie containing at most 6 edges). We proceed to rule out all of these bigons in subcases (i) and (ii), thereby contradicting Corollary 5.4.

First, assume (i). Then 7(a), (d), (e) are impossible by the separation of vertices of  $G_F$ . 7(b) is impossible as it can be used with the (34)–SC of  $\sigma$  to create a Klein bottle in  $M$ . So let  $f$  be the face bounded by the core SC of either 7(c) or 7(f).  $\text{Int } A_3, \text{Int } f$  intersect  $T_1$  in trivial curves (since  $M$  contains no projective planes). We surger away these intersections. Let  $B$  be an annulus on  $T_1$  cobounded by the components of  $a(\tau)$  and containing an edge of  $f$ . Since  $B \cup A_3$  is separating,  $f$  must lie on one side. But this implies that the Möbius band,  $A_f$  corresponding to  $f$  can be pushed off of  $A_3$  so that  $\partial A_f$  is parallel to  $\partial A_3$  on  $T_1$ . Then the long Möbius band  $A_\tau$  can be combined with  $A_f$  to construct a Klein bottle in  $M$ . This rules out all possibilities in subcase (i).

So assume (ii). 7(c), (d), (e), (f) are ruled out by the separation of vertices. 7(b) is impossible as then we can combine its face with the long Möbius band  $A_\tau$  to see a Klein bottle in  $M$ . Thus we assume  $\Lambda$  contains the (67)–SC of 7(a). By Corollary 5.4 and Lemma 10.18, there is a bigon face of  $\Lambda_8$  giving rise to an  $r$ –ESC with  $r \leq 2$ . The possibilities are listed in Figure 24. But 8(c), (d), (e), (f) are ruled out by the separation of vertices. 8(b) is impossible, else it and 7(a) combine along  $T_2$  to make a Klein bottle in  $M$ . Finally, 8(a) can be combined with  $A_\tau$  to give a Klein bottle in  $M$ . This rules out possibility 7(a), hence (ii).

**Case B** *There is a 1–ESC in  $\Lambda$ , but no 2–ESC.*

Assume  $G_Q$  contains  $\tau$ , the ESC depicted in Figure 20. We follow the sequence of lemmas for Case B in SITUATION NO SCC, modifying their proofs as necessary. Note that Proposition 10.27 is proven in the next section under both SITUATION NO SCC and SITUATION SCC.

**Lemma 10.22** *There cannot be two ESCs whose label sets intersect in one label.*

**Proof** Let  $\sigma, \nu$  be such ESCs. As their core SCs are on disjoint label sets,  $F^*$  must consist of two tori, each containing one of these SCs. Then one of these tori must contain all of  $a(\sigma)$ , say, and one component of  $a(\nu)$ . Since this component of  $a(\nu)$  intersects  $a(\sigma)$  once, they must all be isotopic on  $F^*$ . But this contradicts the Addendum to Lemma 4.3. □

Let us now consider the possible bigons of  $\Lambda_8$  and  $\Lambda_7$ . These possibilities are shown in Figure 25.

**Claim 10.23** *Neither 7(d) nor 8(d) may occur.*

**Proof** Since each of these shares one label with  $\tau$ , Lemma 10.22 rules them out. □

**Claim 10.24** *Neither 7(c) nor 8(c) may occur.*

**Proof** Since 7(c) and 8(c) have disjoint labels, by [Proposition 10.27](#) at most one may occur. Assume 7(c) does occur. Then either 8(a) or 8(b) must also occur (8(d) cannot). But then there will be three disjoint SCs, contradicting [Lemma 8.14](#). A similar argument shows 8(c) cannot occur.  $\square$

[Figure 26](#) shows the possible bigons of  $\Lambda_1$  and  $\Lambda_6$ . These will be of use in the next two claims.

**Claim 10.25** *Neither 7(a) nor 8(b) may occur.*

**Proof** Assume 7(a) occurs. With 7(a) and the SC in  $\tau$  each of 1(a) and 1(b) form a triple of disjoint SCs, contradicting [Lemma 8.14](#). 1(c) violates [Proposition 10.27](#).

Therefore 1(d) must occur. Call this 1-ESC,  $\nu$ . Because of 7(a),  $F^*$  must consist of two tori. By the Addendum to [Lemma 4.3](#), one of these,  $T_1$ , contains  $a(\tau)$ , and the other,  $T_2$ , contains the edges of 7(a). But then,  $a(\nu)$  must also lie in  $T_1$ . But then the component of  $a(\nu)$  containing vertex 4 of  $G_F$  must be isotopic to the components of  $a(\tau)$ , contradicting the Addendum to [Lemma 4.3](#). This rules out 1(d), and hence 7(a).

A similar argument rules out 8(b), using  $\Lambda_6$  in place of  $\Lambda_1$ .  $\square$

**Claim 10.26** *There cannot be a (78)-SC.*

**Proof** Assume there is a (78)-SC; ie 7(b) and 8(a) occur. We must consider the bigons of  $\Lambda_1$  and  $\Lambda_6$  shown in [Figure 26](#).

[Proposition 10.27](#) rules out 1(c) and 6(d). The argument of [Claim 10.25](#) rules out 1(d) and 6(c). [Lemma 8.14](#) forbids each of 1(b) and 6(a) as they are SCs each disjoint from the SC in  $\tau$  and the (78)-SC.

Thus 1(a) and 6(b) must occur by [Corollary 5.4](#). But then 1(a), 6(b) and the SC in  $\tau$  form 3 mutually disjoint SCs in violation of [Lemma 8.14](#). Thus there cannot be a (78)-SC.  $\square$

The above claims imply that all bigons of  $\Lambda_8$  are forbidden, contradicting [Corollary 5.4](#).

**Case C** *There is no ESC in  $\Lambda$ .*

In this case every label belongs to an SC. [Lemma 8.14](#) then forces  $t \leq 6$  contrary to the assumed  $t = 8$ . This completes the proof in Case C.

Given the following subsection, the proof of [Proposition 10.17](#) is now complete.  $\square$

### 10.4 A proposition for the preceding subsections

This subsection is devoted to the proof, in both SITUATION NO SCC and SITUATION SCC, of Proposition 10.27 stated below. This proposition was used in the preceding subsections.

**Proposition 10.27** *Assume  $M$  contains no Dyck’s surface and  $t = 8$ . If there is no 2–ESC in  $\Lambda$  then there cannot be two disjoint ESCs.*

Throughout this subsection we assume that there is no 2–ESC and that there exists two disjoint 1–ESCs  $\tau$  and  $\tau'$  on the corners (1234) and (5678) as shown in Figure 29 (with Black and White faces as pictured). At the end of this section we prove Proposition 10.27 by obtaining a contradiction. To do so we must first develop several lemmas.

Let  $A_{23}$  and  $A_{12,34}$  be the White Möbius band and Black annulus arising from  $\tau$ . Let  $A_{67}$  and  $A_{56,78}$  be the White Möbius band and Black annulus arising from  $\tau'$ . By Lemma 8.12 the two components of  $\partial A_{12,34}$  are parallel on  $\hat{F}$  as are the two components of  $\partial A_{56,78}$  (as  $M$  contains no Klein bottle and no Dyck’s surface). By Lemma 8.5 the two annuli  $A_{12,34}$  and  $A_{56,78}$  are parallel into  $\hat{F}$  (the ESCs are maximal, hence  $K$  must be disjoint from their parallelism).

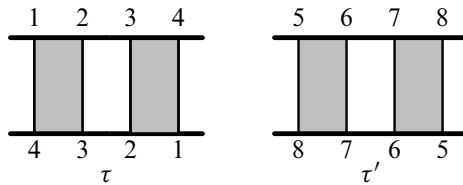

Figure 29

**Claim 10.28** *In SITUATION SCC, there is a separating, meridian disk  $D$  of  $H_B$  disjoint from  $K$  and  $Q$  (ie disjoint from  $Q$  in the exterior of  $K$ ) such that  $\partial D$  separates  $\partial A_{12,34}$  from  $\partial A_{56,78}$ .*

**Proof** Otherwise there is a meridian disk,  $D$ , on one side of  $\hat{F}$  which is disjoint from  $K$  and  $Q$  (see Section 4.2). In particular,  $D$  is disjoint from  $A_{23} \cup A_{12,34}$  and  $A_{67} \cup A_{56,78}$ . But then  $\partial D$  must separate  $\partial A_{12,34}$  and  $\partial A_{56,78}$  (else compressing  $\hat{F}$  along  $D$  gives a 2–torus which allows one to find a Klein bottle in  $M$ ). The disk  $D$  cannot be in  $H_W$  since it is disjoint from the arc (45) of  $K \cap H_W$ . Thus  $D$  lies in  $H_B$  as a separating disk. □

**Lemma 10.29** *The only possible Black bigons of  $\Lambda$  are (12),(34)– and (56),(78)–bigons.*

**Proof** Assume there exists a Black SC. It gives rise to a Black Möbius band  $A'$  that meets either  $A_{12,34}$  or  $A_{56,78}$  along an arc of  $K$ . Since these two annuli are separating, this intersection cannot be transverse. Hence  $A'$  may be slightly nudged to be disjoint from both of these annuli. Thus there are three mutually disjoint Möbius bands in  $M$  each properly embedded in  $H_B$  or  $H_W$ . This is contrary to Lemma 8.11.

The lemma follows immediately in SITUATION SCC since the disk  $D$  of Claim 10.28 separates vertices  $\{1, 2, 3, 4\}$  from  $\{5, 6, 7, 8\}$  on  $\hat{F}$ . So we assume that we are in SITUATION NO SCC. In particular, the above Möbius bands and annuli are properly embedded on the White or Black sides of  $\hat{F}$ .

Assume there exists a (34),(56)–bigon  $g$ . (A similar argument works for (34),(78)–, (12),(56)– and (12),(78)–bigons.) Let  $D_{34}$  and  $D_{56}$  be bridge disks for the arcs (34) and (56) contained in the solid tori cut off from the Black handlebody  $H_B$  by the annuli  $A_{12,34}$  and  $A_{56,78}$ . Then, since  $g$  is not contained in either of these solid tori, together  $D_{34} \cup g \cup D_{56}$  forms a primitivizing disk for  $\partial A_{23}$  (ie a disk in  $H_B$  intersecting  $\partial A_{23}$  once). Note  $D_{34} \cup g \cup D_{56}$  also forms a primitivizing disk for  $\partial A_{67}$ .

Since  $\partial A_{23}$  is primitive with respect to the Black handlebody  $H_B$ ,  $H'_B = H_B \cup N(A_{23})$  is again a handlebody. Now  $K$  intersects  $H'_B$  in the arcs  $(1234) = (12) \cup (23) \cup (34)$ , (56) and (78). Note that the bridge disks for (56), (78) may be taken to be disjoint from  $N(A_{23})$  hence the arcs (56) and (78) are bridge in  $H'_B$ . The arc (1234) lies in the properly embedded Möbius band  $A_{12,34} \cup A_{23}$  in  $H'_B$  and hence has a bridge disk in  $H'_B$  disjoint from the bridge disks for (56) and (78). Hence the arcs for  $K \cap H'_B$  are bridge in  $H'_B$ .

Furthermore since  $A_{23}$  is a Möbius band,  $H'_W = H_W - N(A_{23})$  is also a handlebody. By Lemma 8.16, the arcs  $K \cap H'_W$  are bridge in  $H'_W$ . Therefore  $H'_B$  and  $H'_W$  form a genus 2 Heegaard splitting of  $M$  with respect to which  $K$  is at most 3–bridge. This contradicts that  $t = 8$ . □

Recall that two edges in a graph  $G$  are *in the same edge class* or *are parallel* if they cobound a bigon in the graph (not necessarily a bigon face of the graph).

**Lemma 10.30** *For one of the pairs  $(x, y)$  among the set of pairs  $\{(2, 3), (4, 1), (6, 7), (5, 8)\}$ , there are at most two edge-classes between the vertices  $x, y$  in  $G_F$ .*

**Proof** Otherwise each pair has three such edge-classes. This contradicts that  $\hat{F}$  is genus two.  $\square$

**Lemma 10.31** *For one of either  $i = 1$  or  $i = 5$  the following holds: at each vertex of  $\Lambda$ , there are at most two Black bigons of  $\Lambda$  incident to its  $(i, i + 1)$ -corners and at most two Black bigons of  $\Lambda$  incident to its  $(i + 2, i + 3)$ -corners.*

**Proof** After Lemma 10.30, assume that there are only two edge classes in  $G_F$  connecting vertices 4, 1 of  $G_F$ . Assume there is a vertex  $v$  of  $\Lambda$  that has three (12)-corners belonging to Black bigons of  $\Lambda$ . By Lemma 10.29, the bigons incident at these (12)-corners are (12),(34)-bigons. In particular, each such corner has a  $\overline{41}$ -edge incident at label 1. But this means that one of the edges classes connecting vertices 4, 1 on  $G_F$  has two edges incident to vertex 1 with label  $v$ . This contradicts Lemma 8.15. We get a similar contradiction if there is a vertex of  $\Lambda$  that has three (34)-corners belonging to the same Black bigons of  $\Lambda$ .  $\square$

**Lemma 10.32** *A White bigon of  $\Lambda$  with a (23)- or (67)-corner is a SC.*

**Proof** We may assume we are in SITUATION NO SCC as otherwise by Claim 10.28 there are no edges of  $G_F$  connecting vertices  $\{1, 2, 3, 4\}$  with  $\{5, 6, 7, 8\}$ .

Assume  $g$  is a bigon of  $\Lambda$  with a (23)-corner that is not an SC (the argument for the (67)-corner is analogous). Hence its other corner is a (45)-, (67)- or an (81)-corner. Note that  $g$  is disjoint from the Scharlemann cycle face of  $\tau$ . Thus looking at the (23)-corner of  $g$  along  $\partial N((23))$  along with the ordering of labels of the Scharlemann cycle of  $\hat{F}$  around vertices 2 and 3, the two edges of  $g$  (as edges in  $\hat{F}$ ) must lie on different components of  $\hat{F} - \partial A_{12,34}$ . This implies that  $g$  cannot have a (67)-corner since vertices 6, 7 of  $G_F$  are connected by an edge (of  $\tau'$ ). Let us therefore assume that  $g$  has a (45)-corner; the argument for a (81)-corner is similar. As  $\partial A_{23}, \partial A_{67}$  are not parallel on  $\hat{F}$  (no Klein bottles), the  $\overline{34}$ -edge of  $g$  must be a spanning arc of the annular component of  $\hat{F} - \partial A_{12,34}$  (to which  $A_{12,34}$  is parallel).

Let  $r$  be an arc in the annulus  $A_{12,34}$  sharing endpoints with (34) that projects through the  $\partial$ -parallelism of  $A_{12,34}$  onto the  $\overline{34}$ -edge of  $g$ . Note that up to isotopy rel endpoints,  $r$  is just (34) twisted along  $\partial A_{12,34}$ . So we may take  $r$  to have a single critical value (indeed the same as for (23)) under the height function on  $M$  for the thin presentation of  $K$ . Let  $r'$  be an arc in the annulus  $A_{12,34}$  disjoint from  $r$  and sharing endpoints with (12). Similarly  $r'$  can be taken to have a single critical value with respect to the height function on  $M$ . Then  $r' \cup (23) \cup r$  and  $(12) \cup (23) \cup (34)$  are two properly embedded, non- $\partial$ -parallel arcs in the Möbius band  $A_{23} \cup A_{12,34}$

with the same boundary. By Lemma 8.17, these two arcs are isotopic rel- $\partial$  within this long Möbius band. After this isotopy the bridge arcs (34),(23),(12) are replaced with bridge arcs  $r, (23), r'$ . We may now isotop  $(23) \cup r \cup (45)$ , rel  $\partial$ , onto the  $\overline{25}$ -edge of  $g$ : isotop  $r$  onto the  $\overline{34}$ -edge of  $g$  using the  $\partial$ -parallelism of  $A_{12,34}$ , then use  $g$  to guide the remainder of the isotopy. Perturbing the result slightly into  $H_W$  gives a smaller bridge presentation of  $K$ .  $\square$

**Lemma 10.33** *There is a  $\overline{23}$ -edge class in  $G_F$  that contains an edge of every (23)-SC of  $\Lambda$ . The analogous statement for (67)-SCs also holds.*

**Proof** We prove this for (23)-SCs. The same proof works for (67)-SCs.

We assume first that we are in SITUATION NO SCC. Let  $e_1, e_2$  be the edges of the (23)-SC in  $\tau$ , and let  $f$  be the face that they bound. We assume for contradiction that there is a (23)-SC,  $\sigma_1$ , with no edge parallel to  $e_1$  in  $G_F$  and a (23)-SC,  $\sigma_2$ , of  $G_Q$  with no edge parallel to  $e_2$ . Let  $g_1, g_2$  be the faces of  $G_Q$  bounded by  $\sigma_1, \sigma_2$ . Because of the orderings of the labels around vertices of  $G_F$ , one edge of  $g_i$  must lie in the annulus of  $\hat{F}$  bounded by  $\partial A_{12,34}$ . This implies that one edge of  $g_i$  is parallel to  $e_j$ , where  $\{i, j\} = \{1, 2\}$  (note that the interior of this annulus is disjoint from  $K$ ). By identifying  $f$  with  $g_1$  along their parallel edges (in the class of  $e_2$ ) we get a disk  $D_1$  properly embedded in  $H_W$  whose boundary is given by the curve  $e_1 \cup e^1$ , where  $e^1$  is the edge of  $\sigma_1$  not parallel to  $e_2$ . Similarly identifying  $f$  with  $g_2$ , we get a meridian disk  $D_2$  of  $H_W$  whose boundary is the curve  $e_2 \cup e^2$ , where  $e^2$  is the other edge of  $\sigma_2$ . By looking at the ordering of these edges around the vertices 2, 3 of  $G_F$  we see that we can take  $D_1, D_2, A_{23}$  (along with  $A_{67}$ ) to be disjoint. Both  $D_1, D_2$  must be separating in  $H_W$  (else there is a Klein bottle or projective plane in  $M$ ). Then  $\partial D_1$ , say, must separate  $\partial D_2$  from  $\partial A_{23}$ . But again looking at the ordering of the edges of these SCs around vertices 2, 3 of  $G_F$  shows that this does not happen.

Thus we assume we are in SITUATION SCC. Let  $D$  be the separating disk of  $H_B$  given by Claim 10.28. Then there can be at most three edge-classes of  $\overline{23}$ -edges in  $G_F$  (surgering  $\hat{F}$  along  $D$  gives two 2-tori, one containing  $\partial A_{12,34}$  and the other  $\partial A_{56,78}$ ). If the Lemma is false, then there must be exactly three such edge-classes and there must be three (23)-SCs of length two representing each pair of these edge-classes. One of these SCs is that of  $\tau$ , and again let  $e_1, e_2$  be its edges. The other two of these SCs  $\sigma_1, \sigma_2$ , each have an edge in the  $\overline{23}$ -edge class,  $\epsilon$ , not represented by  $e_1, e_2$ . Let  $f_1, f_2$  be the faces bounded by  $\sigma_1, \sigma_2$  in  $G_Q$ . Identifying  $f_1, f_2$  along their edges in class  $\epsilon$  gives a disk  $D'$  which is almost properly embedded in  $H_W$  whose boundary is the curve  $e_1 \cup e_2$  in  $\hat{F}$ . Then Lemma 3.3 implies that  $\partial D'$  bounds a disk,  $D''$  on one side of  $\hat{F}$ . But then  $A_{23}$  and  $D''$  can be used to construct a projective plane in  $M$ , a contradiction.  $\square$

**Corollary 10.34** *At every vertex of  $\Lambda$  there are at most two bigons of  $\Lambda$  at (23)–corners and at most two bigons at (67)–corners.*

**Proof** Lemma 10.32 says that any bigon of  $\Lambda$  at a (23)– or (67)–corner must be an SC. By Lemma 10.33, there is a  $\overline{23}$ –edge class containing an edge of any (23)–SC and a  $\overline{67}$ –edge class containing an edge of any (67)–SC. Hence if there were three (23)–SCs or three (67)–SCs at a vertex, then two of the edges would be parallel on  $G_F$  meeting a vertex at the same label. Lemma 8.15 forbids this.  $\square$

**Proof of Proposition 10.27** By Lemmas 5.10 and 5.13,  $\Lambda$  has a vertex  $v$  of type  $[8\Delta - 5]$  (there are no 2–ESCs). Hence  $v$  has at most 5 gaps, ie corners to which bigons of  $\Lambda$  are not incident. By Lemma 10.31, without loss of generality there exists a gap at a (12)–corner and a (34)–corner of  $v$ . By Corollary 10.34, there must be a gap at a (23)–corner and a (67)–corner. This accounts for 4 of the gaps. We now enumerate and rule out the possibilities for the remaining gap.

Since  $\Delta \geq 3$ ,  $v$  has at least three runs of the sequences of labels 4567812. The (23)–gap and (34)–gap are not contained in these sequences. Each such sequence must have at least one gap, else by Lemma 10.32, there would be a 2–ESC (contradicting our assumptions). Thus  $\Delta = 3$  and the (67)–gap, the (12)–gap and the fifth gap must be in different runs of the sequence. But the run containing the (12)–gap will have five consecutive bigons on 456781, and, as above, Lemma 10.32 guarantees a 2–ESC.  $\square$

## 11 $t < 6$

The goal of this section is the proof of:

**Theorem 11.1** *Either  $M$  contains a Dyck’s surface or  $t < 6$ .*

**Proof** For contradiction we assume  $M$  contains no Dyck’s surface and, by the earlier sections, that  $t = 6$ . Given Corollary 5.4, there are four ways in which  $\Lambda_x$  contains a bigon for each  $x$ :

- (A) There is a 2–ESC in  $\Lambda$ .
- (B) There are two 1–ESCs in  $\Lambda$  whose label sets overlap in exactly two labels.
- (C) There are three SCs whose corresponding Möbius bands are disjoint.
- (D) There is a 1–ESC and a disjoint SC in  $\Lambda$ .

Hence we proceed to address these four cases. The arguments will need to account for each of the two possibilities: SITUATION NO SCC and SITUATION SCC.



**Case A** There is a 2-ESC in  $\Lambda$ .

Assume  $\sigma$  is a 2-ESC in  $\Lambda$  with corner (612345) so that it contains a (23)-SC. Let  $A_{23}$  be the White, say, Möbius band,  $A_{12,34}$  be the Black annulus, and  $A_{61,45}$  be the White annulus of the long Möbius band corresponding to  $\sigma$ , where the subscripts indicate the subarcs of  $K$  lying in these surfaces.

**Subcase A(i)** SITUATION NO SCC holds.

Then  $A_{23}, A_{12,34}, A_{61,45}$  are properly embedded on each side of  $\widehat{F}$ . Furthermore, by Lemma 8.13,  $\partial A_{12,34}$  is nonseparating in  $H_B$  and  $A_{61,45}$  is isotopic in  $H_W$  onto  $\widehat{F}$ .

**Lemma 11.2** *There is a nonseparating disk  $D$  in  $H_B$  disjoint from  $A_{12,34}$  and all arcs of  $K \cap H_B$ .*

**Proof** One can find a bridge disk for the arc (12) of  $K$  whose interior is disjoint from  $A_{12,34}$  and  $K$ . Using this to  $\partial$ -compress a push-off of  $A_{12,34}$  gives the desired disk. □

Let  $\mathcal{T}$  be the solid torus obtained by cutting  $H_B$  along  $D$ . Then  $A_{12,34}$  is properly embedded in  $\mathcal{T}$  and  $A_{23}, A_{61,45}$  in  $M - \mathcal{T}$ . Then  $a(\sigma)$  is three parallel curves on  $\partial\mathcal{T}$ . Let  $B, B'$  be the annuli on  $\mathcal{T}$  between  $\partial A_{61,45}, \partial A_{12,34}$  (respectively) on  $\partial\mathcal{T}$  whose interiors are disjoint from  $K$ . Because  $A_{12,34}$  is nonseparating in  $H_B$ ,  $B'$  intersects  $N(D)$  in a disk.  $B$  is disjoint from  $N(D)$ . The Addendum to Lemma 8.5 applied to the long Möbius band  $A_{23} \cup A_{12,34}$  (ie to the 1-ESC), with  $\partial\mathcal{T}$  as  $F^*$ , shows that  $B' \cup A_{12,34}$  bounds a solid torus,  $V'$  whose interior is disjoint from  $K$  and in which  $B'$  is longitudinal. That is,  $V'$  guides an isotopy of  $A_{12,34}$  to  $B'$ , and, hence, an isotopy (rel endpoints) of the arcs (12) and (34) of  $K$  onto  $\widehat{F} \cap B'$ . At the same time, there is an isotopy in  $H_W$  of  $A_{61,45}$  onto  $B$ , and hence of the arcs (61) and (45) (rel endpoints) onto  $B$ . This allows us to thin  $K$  to be 1-bridge, contradicting that  $t = 6$  and thereby proving Theorem 11.1 in Subcase A(i).

**Subcase A(ii)** SITUATION SCC holds.

There is a meridian disk,  $D$ , disjoint from  $K$  and  $Q$ . Let  $F^*$  be  $\widehat{F}$  surgered along  $D$ . By Lemma 4.2 and the Addendum to Lemma 8.10,  $F^*$  consists of two tori:  $T_1$  containing two components of  $a(\sigma)$ , and  $T_2$  containing one. Finally, by the Addendum to Lemma 8.5, components of  $a(\sigma)$  that are isotopic on  $F^*$  must be consecutive along the long Möbius band. Thus the vertices of  $G_F$  on  $T_2$  are either:

- (i)  $\{2, 3\}$
- (ii)  $\{5, 6\}$

Assume (i) holds. The separation of vertices implies there are no bigons of  $\Lambda$  with corner (56). (Since there are no  $\overline{25}$ -edges or  $\overline{36}$ -edges, such a bigon would have to be an SC. Its corresponding Möbius band would have boundary isotopic on  $T_1$  to a component of  $\partial A_{61,45}$  permitting the construction of an embedded Klein bottle.) Furthermore, any face of  $\Lambda$  containing a (23)-corner must be a (23)-SC and, since  $M$  contains no Klein bottles, the edges of any two such (23)-SCs must be parallel on  $T_2$  (ie lie in two edge classes on  $T_2$ ). Again by separation, any Black bigon of  $\Lambda$  with either a (12)-corner or a (34)-corner must be a (12),(34)-bigon, and the  $\overline{41}$ -edges of any such bigon must be parallel on  $T_1$  to one of the  $\overline{41}$ -edges of  $\sigma$ . Thus by Lemma 8.15, at most two (23)-corners, at most two (12)-corners, and at most two (34)-corners of bigons of  $\Lambda$  may be incident to a vertex of  $\Lambda$ . Since  $\Delta \geq 3$ , the above implies that a vertex of  $\Lambda$  must have at least 6 corners (in fact at least 9) not incident to bigons of  $\Lambda$ . So Lemmas 5.11 and 5.14 imply that  $\Lambda$  must have an edge class containing 8 edges. But among 8 consecutive mutually parallel edges of  $\Lambda$  one must have a bigon at a (56)-corner.

Thus we may assume that (ii) occurs. We are assuming (45) of  $K$  lies in  $H_W$ ; thus, by separation, the meridian disk  $D$  along which we surger to get  $F^*$  must be a meridian of  $H_B$ . Then  $H_B - N(D)$  is two solid tori,  $\mathcal{N} = \mathcal{N}_1 \cup \mathcal{N}_2$ , where  $\partial \mathcal{N}_i = T_i$ . After surgery along trivial curves of intersection on  $F^*$ , we may take  $A_{23}, A_{12,34}, A_{61,45}$  to be properly embedded in  $\mathcal{N}$  or its exterior.

First assume  $\partial A_{61,45}$  is longitudinal in each of the solid tori  $\mathcal{N}_1$  and  $\mathcal{N}_2$ . Then  $W = \mathcal{N} \cup N(A_{23} \cup A_{61,45})$  is a solid torus. Since  $K$  lies entirely in  $W$ , the exterior of  $K$  is irreducible and atoroidal, and  $M$  is not a lens space,  $K$  must be isotopic to a core of  $W$ . But then the core,  $L$ , of the solid torus  $\mathcal{N}_1$  is a (2,1)-cable of  $K$ . As  $L$  is a core of  $H_B$ , Claim 8.7 contradicts that  $t = 6$ .

Next assume that  $\partial A_{61,45}$  is not longitudinal in  $\mathcal{N}_2$ . Let  $A' = A_{23} \cup A_{12,34} \cup A_{61,45}$  be the long Möbius band properly embedded in the exterior of  $\mathcal{N}_2$  and set  $U = \mathcal{N}_2 \cup N(A')$ . Then  $U$  is Seifert fibered over the disk with two exceptional fibers. We may isotop  $K$  in  $U$  so that  $K$  is the union of two arcs:  $\alpha$  in  $\partial U \cap N(A')$ , and  $\beta$  isotopic to the arc (56) of  $K \cap \mathcal{N}_2$ . Since (56) is bridge in  $H_B$ , it is bridge in  $\mathcal{N}_2$ . Let  $\gamma$  be a cocore of the annulus  $N(A') \cap \mathcal{N}_2$ . Then  $V = U - N(\gamma)$  is a genus two handlebody in which  $\beta$  is bridge (the intersections of a bridge disk with  $N(A') \cap \mathcal{N}_2$  can be isotoped onto  $N(\gamma)$ ). Furthermore,  $M - U$  must be a solid torus (the exterior of  $K$  is irreducible and atoroidal); hence,  $M - V$  is genus 2 handlebody. Thus  $K$  is at most 1-bridge ( $t \leq 2$ ) with respect to the Heegaard handlebody  $V$  of  $M$ , contradicting that  $t = 6$ .

Thus  $\partial A_{61,45}$  must be longitudinal in  $\mathcal{N}_2$  and hence must not be longitudinal in  $\mathcal{N}_1$ . Let  $U = \mathcal{N}_1 \cup N(A_{23})$  and  $A' = A_{23} \cup A_{12,34}$ . Then  $U$  is a Seifert fiber space over

the disk with two exceptional fibers and  $A'$  is a properly embedded Möbius band in  $U$  whose boundary is a Seifert fiber. As  $K \cap U$  is a spanning arc of  $A'$ , Lemma 8.3 contradicts that  $t = 6$ .

This final contradiction finishes the proof of Theorem 11.1 in Subcase A(ii).

**Case B** *There are two 1-ESCs in  $\Lambda$  whose label sets overlap in two labels.*

First note that we may assume in Case B that SITUATION NO SCC holds. For if SITUATION SCC holds, there is a meridian disk  $D$  of either  $H_W$  or  $H_B$  disjoint from  $Q$  and  $K$ . WLOG we may assume the two ESCs are as in Figure 30. The edges of Figure 30 show that either  $\partial D$  on  $\hat{F}$  must separate vertices  $\{1, 4, 5\}$  from  $\{2, 3, 6\}$  or there is a projective plane or Klein bottle in  $M$ . The first is impossible as  $D$  is disjoint from  $K$ , the second since the surgery slope is nonintegral.

Assume there are two ESCs  $\sigma$  and  $\sigma'$  on the corners (1234) and (3456) respectively as shown in Figure 30.

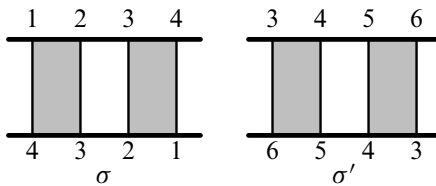

Figure 30

Let  $A_{23}$  and  $A_{45}$  be the two White Möbius bands arising from the SCs contained within  $\sigma$  and  $\sigma'$ . Let  $A_{12,34}$  and  $A_{34,56}$  be the two Black annuli arising from the remaining two pairs of bigons. As we are in SITUATION NO SCC we have that  $A_{23}, A_{12,34}, A_{45}, A_{34,56}$  are properly embedded on their sides of  $\hat{F}$ .

If either  $A_{12,34}$  or  $A_{34,56}$  is separating in  $H_B$ , then since  $A_{12,34} \cap A_{34,56} = (34)$  they cannot intersect transversely. Hence  $A_{12,34}$  and  $A_{34,56}$  may be slightly isotoped to be disjoint. In particular, after this isotopy we may assume  $\partial A_{23}$  is disjoint from  $\partial A_{34,56}$  (and isotopic to neither component) and similarly  $\partial A_{45}$  is disjoint from  $\partial A_{12,34}$ . Then by Lemma 8.12 the components of  $\partial A_{12,34}$  must be parallel and the components of  $\partial A_{34,56}$  must be parallel. Thus both of these annuli are separating.

Therefore either both  $A_{12,34}$  and  $A_{34,56}$  are separating in  $H_B$  or both are nonseparating in  $H_B$ .

**Subcase B(i)** Both  $A_{12,34}$  and  $A_{34,56}$  are separating in  $H_B$ .

As noted above,  $A_{12,34}$  and  $A_{34,56}$  must intersect nontransversely along the arc (34) and can be perturbed to be disjoint. The annulus  $A_{12,34}$  separates  $H_B$  into a solid torus  $\mathcal{T}$  and a genus 2 handlebody. As  $M$  contains no Klein bottle,  $A_{34,56}$  lies outside of  $\mathcal{T}$ . Surgering along innermost closed curves and outermost arcs of intersection, we can find a bridge disk,  $D_{34}$ , for (34) of  $K \cap H_B$  that intersects  $A_{12,34}$  only along (34). We first assume  $D_{34}$  lies outside  $\mathcal{T}$ , ie it intersects it only in the arc (34). Then  $\partial N(D_{34} \cup A_{12,34}) \setminus \partial H_B$  is an essential disk  $D$  and an annulus  $A$ .

The annulus  $A$  chops  $H_B$  into a solid torus  $\mathcal{T}'$  on which one impression of  $A$  on  $\partial \mathcal{T}'$  runs  $n \geq 1$  times longitudinally and a genus 2 handlebody  $H'_B$  that contains  $A_{34,56}$  and  $A_{12,34}$  such that  $A_{12,34}$  is  $\partial$ -parallel to the other impression of  $A$  on  $\partial H'_B$ . Then  $D_{34}$  marks  $\partial A_{23}$  as a primitive curve on  $H'_B$ . Also note that by banding across  $A_{12,34} \cup D_{34}$ , the arc (56) has a bridge disk  $D_{56}$  that is disjoint from  $N(A_{12,34} \cup D_{34})$  and thus from  $D$ .

Attach  $N(A_{23})$  to  $H'_B$  along the annulus  $N(\partial A_{23})$  to form  $H''_B$ . Since  $\partial A_{23}$  is primitive in  $H'_B$ ,  $H''_B$  is a genus 2 handlebody. Note that the arc (1234) of  $K \cap H''_B$  lies in a Möbius band in  $H''_B$  and hence is bridge. The arc (56) is bridge in  $H''_B$  as it has a bridge disk disjoint from  $D$ .

By Lemma 8.16 both arcs (45) and (61) have bridge disks in  $H_W$  disjoint from  $A_{23}$ . Thus they both have bridge disks in the genus 2 handlebody  $H'_W = H_W - N(A_{23})$ . Attach  $\mathcal{T}'$  to  $H'_W$  along the annulus  $A' = \partial \mathcal{T}' \setminus A = \partial \mathcal{T}' \cap \partial H_W$  to form  $H''_W$ . Since  $A'$  has  $\partial A_{23}$  as one of its boundary components it is primitive on  $H'_W$  and thus  $H''_W$  is a genus 2 handlebody. Moreover, since  $\mathcal{T}'$  is disjoint from  $K$ , so is  $A'$ ; thus the bridge disks for (45) and (61) may be assumed to be disjoint from  $A'$  as well. Hence these two arcs are bridge in  $H''_W$ .

Therefore  $H''_B \cup H''_W$  is a new genus 2 Heegaard splitting for  $M$  in which  $K$  has a 2-bridge presentation. This is contrary to assumption. Hence it must be that  $D_{34}$  lies in  $\mathcal{T}$ .

**Remark 11.3** If  $\partial A_{23}$  is longitudinal in  $\mathcal{T}'$ , the new Heegaard splitting,  $H''_B \cap H''_W$ , comes from the old (up to isotopy) by adding/removing a primitive Möbius band as described in the proof of Theorem 2.6. If  $\partial A_{23}$  is not longitudinal in  $\mathcal{T}'$ , then  $M$  is a Seifert fiber space over the 2-sphere with an exceptional fiber of order 2. In this case, we could find a vertical splitting with respect to which  $K$  has smaller bridge number by applying Lemma 8.3 to  $N(A_{23}) \cup \mathcal{T}'$ , a Seifert fiber space over the disk. This would then be consistent with the proof of Theorem 2.6.

Let  $\mathcal{T}''$  be the solid torus that  $A_{34,56}$  separates off  $H_B$ . Since  $M$  contains no Klein bottles,  $\mathcal{T}$  lies outside of  $\mathcal{T}''$ ; hence, so is  $D_{34}$ . Apply the above argument to  $A_{34,56}$  in place of  $A_{12,34}$  to get a 2-bridge presentation of  $K$ .

**Subcase B(ii)** Both  $A_{12,34}$  and  $A_{34,56}$  are nonseparating in  $H_B$ .

Since no pair of the four components of  $\partial A_{12,34} \cup \partial A_{34,56}$  may be isotopic on  $\hat{F}$  (else we get a Klein bottle),  $A_{12,34}$  and  $A_{34,56}$  intersect transversely along (34). Since  $H_B$  is a handlebody,  $H_B - N(A_{12,34} \cup A_{34,56})$  is a single solid torus on which the annulus  $\partial H_B \setminus \partial(A_{12,34} \cup A_{34,56})$  is a longitudinal annulus. That is,  $H_B$  is isotopic to  $N(A_{12,34} \cup A_{34,56})$ . Then  $\partial A_{23}$  is primitive in  $H_B$ . Furthermore, the arc (56) has a bridge disk in  $H_B$  disjoint from  $A_{12,34}$ .

Since  $\partial A_{23}$  is primitive in  $H_B$ , we may form the genus 2 handlebody  $H'_B$  by attaching  $N(A_{23})$  to  $H_B$  along  $N(\partial A_{23})$ . Its complement  $H'_W = H_W - N(A_{23})$  is also a genus 2 handlebody. Thus together  $H'_W$  and  $H'_B$  form a new genus 2 Heegaard splitting for  $M$ .

The White arcs  $K \cap H_W$  other than (23) continue to be bridge in  $H'_W$ . Furthermore, since there is a bridge disk  $D_{56}$  in  $H_B$  for the Black arc (56) that is disjoint from  $A_{12,34}$ ,  $D_{56}$  continues to be a bridge disk for (56) in  $H'_B$ . Finally, the arc (1234) is bridge in  $H'_B$  as it lies in the Möbius band  $A_{12,34} \cup A_{23}$ .

Thus the handlebodies  $H'_W$  and  $H'_B$  form a new genus 2 Heegaard splitting for  $M$  in which  $K$  is at most 2-bridge. This contradicts the assumption that  $t = 6$ .

This completes the proof of Subcase B(ii) and hence Case B cannot occur.

**Case C** *There are three mutually disjoint SCs in  $\Lambda$ .*

**Lemma 8.11** (independent of SITUATION NO SCC and SITUATION SCC) implies Case C does not occur.

**Case D** *There is a 1-ESC and disjoint SC in  $\Lambda$ .*

This case is considered in the following [Section 12](#). [Proposition 12.1](#) shows Case D cannot occur.

This completes the proof of [Theorem 11.1](#). □

## 12 Case D of Theorem 11.1

In this section we show:

**Proposition 12.1** *Case D of Theorem 11.1 cannot occur. That is, if*

- (1)  $t = 6$ ,
- (2)  $\Lambda$  contains no 2-ESC,
- (3)  $\Lambda$  contains a 1-ESC and an SC on a disjoint label sets,

*then  $M$  contains a Dyck’s surface.*

**Proof** Assume  $M$  does not contain a Dyck’s surface. Assume there is an ESC  $\tau$  with labels  $\{1, 2, 3, 4\}$  and an SC  $\sigma$  with labels  $\{5, 6\}$  as shown in Figure 31. Let  $A_{23}$  and  $A_{12,34}$  be the White Möbius band and Black annulus arising from  $\tau$ . Let  $A_{56}$  be the Black Möbius band arising from  $\sigma$ . By Lemma 8.12 (and that  $M$  contains no Klein bottle or projective plane) the components of  $\partial A_{12,34}$  must be parallel on  $\hat{F}$  bounding an annulus  $B_{12,34}$  in  $\hat{F}$ . Then by Lemma 8.5,  $A_{12,34}$  is isotopic in  $M$  to  $B_{12,34}$ .

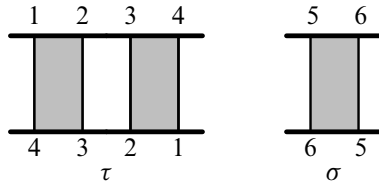

Figure 31

We consider the arguments of this subsection under both possibilities, SITUATION NO SCC and SITUATION SCC.

**Claim 12.2** *In SITUATION SCC, there is a separating, meridian disk  $D$  of  $H_B$  disjoint from  $K$  and  $Q$ . Let  $F^*$  be  $\hat{F}$  surgered along  $D$ . Then  $F^*$  is two tori,  $T_1, T_2$ , where vertices  $\{1, 2, 3, 4\}$  lie on  $T_1$  and vertices  $\{5, 6\}$  on  $T_2$ .*

**Proof** Recall that SITUATION SCC implies that there is a meridian disk on one side of  $\hat{F}$  that is disjoint from  $K$  and from  $Q$ . First assume this disk was nonseparating. Compressing  $\hat{F}$  along it would produce a 2-torus that intersected the interiors of  $A_{23}, A_{56}$  only in trivial curves. Surgering away such intersections exposes either a projective plane or Klein bottle in  $M$ . So this disk must be separating on one side of  $\hat{F}$ . It is disjoint from  $B_{12,34}$  else it along with  $A_{23}$  forms a projective plane in  $M$ . Thus the boundary of this disk must separate vertices  $\{1, 2, 3, 4\}$  in  $\hat{F}$  from vertices  $\{5, 6\}$ . Since the disk is disjoint from the (45)-arc of  $K$ , it must be in  $H_B$ .  $\square$

**Lemma 12.3** *In SITUATION NO SCC, the edges of all (23)–SCs of  $\Lambda$  belong to two parallelism classes in  $G_F$ . In SITUATION SCC, all (23)–edges belong to two parallelism classes in  $G_{F^*}$ , where  $G_{F^*}$  is the graph induced on  $F^*$  from  $G_F$ .*

**Proof** First assume SITUATION SCC holds and Claim 12.2 applies. Because the components of  $\partial A_{12,34}$  are disjoint, essential curves in  $T_1$ , any  $\overline{23}$ –edge of  $\Lambda$  is parallel on  $G_{F^*}$  to one of the  $\overline{23}$ –edges of  $\tau$ .

Thus we assume we are in SITUATION NO SCC. Let  $\nu$  be the core (23)–SC of  $\tau$ , and assume there is another (23)–SC,  $\nu'$ , with an edge that is not parallel on  $G_F$  to either edge of  $\nu$ . Let  $f, f'$  be the faces bounded by  $\nu, \nu'$ . Let  $A'_{23}$  be the Möbius band corresponding to  $f'$ . By the ordering of the labels around the vertices 2, 3 of  $G_F$ , one edge,  $e'_1$ , of  $\nu'$  must lie within  $B_{12,34}$  and the other,  $e'_2$ , outside. That is,  $e'_1$  is parallel in  $G_F$  to an edge  $e_1$  of  $\nu$ .

We may use the parallelism between  $e_1, e'_1$ , along with the parallelisms of the corners of  $f, f'$  along  $\partial N((23))$ , to band together  $f, f'$  to get a properly embedded disk  $D'$  in  $H_W$ . Here  $\partial D'$  is the curve  $e_2 \cup e'_2$  on  $\hat{F}$ , where  $e_2$  is the edge of  $\nu$  other than  $e_1$ . By an inspection of the labeling around vertices 2, 3 of  $G_F$ , one can see that the  $D'$  can be taken to be disjoint from both  $A_{23}, A'_{23}$  and  $K$ . As  $e_2, e'_2$  are not parallel on  $G_F$ ,  $\partial D'$  is not trivial on  $\hat{F}$ .  $\partial D'$  must separate  $\partial A_{23}, \partial A'_{23}$  from  $\partial A_{56}$  on  $\hat{F}$ , since  $M$  contains no Klein bottles. But this contradicts that  $D'$  is disjoint from the (45)–arc of  $K$ . □

**Lemma 12.4** *In SITUATION NO SCC, no White bigon or trigon has an edge that is a spanning arc of  $B_{12,34}$ .*

**Proof** Let  $f$  be a White bigon or trigon with such an edge  $e$ . We assume  $e$  is a  $\overline{34}$ –edge, the argument for when it is a  $\overline{12}$ –edge is the same. There is a bridge disk (disjoint from the remaining bridge disks) for some arc of  $K \cap H_W$  that is disjoint from  $f$  (except possibly along that arc) and hence from  $\text{Int } e$  (after removing trivial arcs and simple closed curves of intersection of  $f$  with a collection of bridge disks,  $D$ , an outermost arc of intersection on  $D$  will cut out the desired bridge disk, after possibly banding along  $f$  to  $K \cap H_W$ ).

Let  $r$  be an arc in the annulus  $A_{12,34}$  sharing endpoints with (34) that projects through the  $\partial$ –parallelism of  $A_{12,34}$  onto the  $\overline{34}$ –edge of  $f$ . That is, there is a bridge disk for  $r, D_r$ , that intersects  $\hat{F}$  in  $e$ . Note that up to isotopy rel endpoints,  $r$  is just (34) twisted along  $\partial A_{12,34}$ . So we may take  $r$  to have a single critical value (indeed the same as for (34)) under the height function on  $M$  for the thin presentation of  $K$ . Let  $r'$  be an arc in the annulus  $A_{12,34}$  disjoint from  $r$  and sharing endpoints with (12).

Similarly  $r'$  can be taken to have a single critical value with respect to the height function on  $M$ . Then  $r' \cup (23) \cup r$  and  $(12) \cup (23) \cup (34)$  are two properly embedded, non- $\partial$ -parallel arcs in the Möbius band  $A_{23} \cup A_{12,34}$  with the same boundary. By Lemma 8.17, these two arcs are isotopic rel- $\partial$  within this long Möbius band. Perform this isotopy, then use the Black bridge disk  $D_r$  along with the White bridge disk of the preceding paragraph to give a thinner presentation of  $K$ ; a contradiction.  $\square$

**Lemma 12.5** *The only type of White bigon in  $\Lambda$  that is not an SC is a (45),(61)-bigon.*

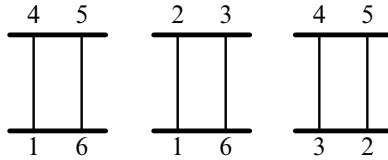

Figure 32

**Proof** The three possible non-Scharlemann White bigons are shown in Figure 32. We will rule out the two that have a (23)-corner. Note that we may assume we have SITUATION NO SCC because of the separation that comes from Claim 12.2 in SITUATION SCC. Let us focus on the bigon  $R$  with the  $\overline{12}$ -edge as the proof is analogous for the other.

Since  $R$  has a (23)-corner, the labeling around vertices 2, 3 of  $G_F$  forces the edges  $\overline{12}$  and  $\overline{36}$  to be incident to the vertices 2 and 3 on opposite sides of  $\partial A_{23}$  in  $\widehat{F}$ . Therefore since the  $\overline{36}$ -edge must connect vertex 3 to vertex 6, the  $\overline{12}$ -edge must lie in the annulus  $B_{14,23}$ . But this contradicts Lemma 12.4.  $\square$

**Corollary 12.6** *At most two (23)-corners at a vertex belong to bigons of  $\Lambda$ .*

**Proof** Assume there are three (23)-corners at vertex  $x$  of  $\Lambda$  belonging to bigons of  $\Lambda$ . By Lemma 12.5, these bigons must all be SCs. By Lemma 12.3 these six edges belong to two parallelism classes on either  $G_F$  or  $G_{F^*}$ . Therefore two of these six edges must be incident to the same vertex of  $G_F$  ( $G_{F^*}$ ) at the label  $x$  and parallel. This violates Lemma 8.15 (Lemma 12.15). (If only two bigons are incident at these three corners, two of the edges will have label  $x$  at both ends in  $G_F$  and Lemma 8.15 (Lemma 12.15) is still violated).  $\square$

**Lemma 12.7**  *$\Lambda$  does not contain a (12)- or a (34)-SC.*



**Proof** Assume there exists a (34)–SC. Let  $A_{34}$  be the corresponding Möbius band.

Since the annulus  $A_{12,34}$  cobounds a solid torus with  $B_{12,34}$ , the Möbius band  $A_{34}$  must intersect  $A_{12,34}$  tangentially. Therefore  $A_{34}$  may be isotoped to be disjoint from  $A_{23}$ . Since it is also disjoint from  $A_{56}$ , Lemma 8.11 implies that  $M$  contains a Dyck’s surface.

A similar argument rules out the existence of a (12)–SC. □

**Lemma 12.8** *There cannot be an ESC with labels  $\{4, 5, 6, 1\}$ .*

**Proof** Assume there is such an ESC and take  $\sigma$  to be its core SC. Let  $A_{45,61}$  be the corresponding annulus formed from the bigons that flank  $\sigma$ . Observe that  $A_{45,61}$  is disjoint from the Möbius band  $A_{23}$ , and  $A_{12,34}$  is disjoint from the Möbius band  $A_{56}$ . Then by Lemma 8.12 (and that there are no Klein bottles in  $M$ ) the components of  $\partial A_{45,61}$  must be parallel as must the components of  $\partial A_{12,34}$ . This contradicts Claim 12.2 in SITUATION SCC. In SITUATION NO SCC, Lemma 8.5 implies these annuli must be isotopic into  $\hat{F}$ . Together these parallelisms give a thinning of  $K$ . □

**Corollary 12.9** *There cannot be three consecutive bigons around a vertex with a (4561)–corner.*

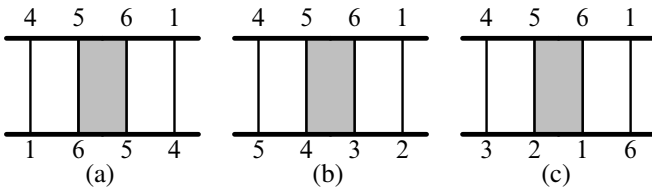

Figure 33

**Proof** Assume there were. Then there are three possibilities according to whether opposite the (56)–corner is the (56)–, (34)– or (12)–corner. These are shown in Figure 33. The first is ruled out by Lemma 12.8 since it is an ESC with labels  $\{4, 5, 6, 1\}$ . The second and third are ruled out since they contain the non–SC White bigons prohibited by Lemma 12.5. □

**Lemma 12.10** *In SITUATION NO SCC there cannot be a White trigon with a single (23)–corner. In SITUATION SCC the only White trigon with a single (23)–corner, is possibly a (23), (45), (61)–trigon consisting of  $\overline{34}$ ,  $\overline{56}$ ,  $\overline{12}$ –edges.*

**Proof** If there were such a trigon, then its two edges incident to that corner must be incident to opposite sides of  $\partial A_{23}$  on  $\widehat{F}$ . Thus one of these edges must be a spanning arc of  $B_{12,34}$ . In SITUATION NO SCC this is prohibited by Lemma 12.4. In SITUATION SCC the separation of Claim 12.2 guarantees there are no  $\overline{25}$ - or  $\overline{36}$ -edges, giving the desired conclusion.  $\square$

**Lemma 12.11** *There cannot be a Scharlemann cycle of length 3 on the labels  $\{2, 3\}$ .*

**Proof** Assume  $g$  is the trigon face of such a (23)-Scharlemann cycle. The ends of two edges of  $g$  incident to the same corner of  $g$  must be incident to opposite sides of  $\partial A_{23}$  as they lie on  $\widehat{F}$ . Since the annulus  $B_{12,34}$  has  $\partial A_{23}$  as a boundary component, around  $\partial g$  the edges are alternately in or not in  $B_{12,34}$ . This of course cannot occur since  $g$  has three edges.  $\square$

**Lemma 12.12** *In  $\Lambda$ , a trigon cannot have exactly two (23)-corners.*

**Proof** First we assume SITUATION SCC holds. This means there is a Black meridian disjoint from  $G_F$  separating vertices  $\{1, 2, 3, 4\}$  and  $\{5, 6\}$ . The third corner of a trigon with two (23)-corners must be either a (61)-corner or a (45)-corner. But then  $G_F$  has an edge joining either vertices 2 and 5 or vertices 3 and 6, a contradiction.

Thus we may assume we are in SITUATION NO SCC. Assume  $g$  is a trigon with two (23)-corners and, WLOG, one (61)-corner. We shall construct a bridge disk for (61) that does not intersect the interior of  $B_{12,34}$ . Such a bridge disk for (61) is disjoint from a bridge disk for (34) and hence provides a contradictory thinning of  $K$ .

Because the  $\overline{12}$ -edge and the  $\overline{36}$ -edge of  $g$  must be incident to the side of  $\partial A_{23}$  opposite from which the  $\overline{23}$ -edge is incident (by the labeling around vertices 2, 3 of  $G_F$ ), neither of them lie in the annulus  $B_{12,34}$ . Furthermore, the  $\overline{23}$ -edge is parallel in  $G_F$  to a  $\overline{23}$ -edge of the SC in  $\tau$ . Let  $f$  be the bigon face of the SC in  $\tau$ . Let  $\delta$  be the rectangle of parallelism on  $G_F$  between the two  $\overline{23}$ -edges of  $g$  and  $f$ ; its other two sides are arcs of the vertices 2 and 3. Let  $\rho$  and  $\rho'$  be the disjoint rectangles on  $\partial N(K)$  between the two (23)-corners of  $g$  and the two (23)-corners of  $f$ ; the other two sides of each of  $\rho, \rho'$  being arcs of the vertices 2 and 3. Then  $g \cup \delta \cup \rho \cup \rho' \cup f$  forms a disk  $D_{61}$  whose boundary is composed of the (61)-corner of  $g$  and an arc on  $\widehat{F}$ ; see Figure 34. By a slight isotopy, the interior of this arc on  $\widehat{F}$  may be made disjoint from  $B_{12,34}$ . Thus  $D_{61}$  is the desired bridge disk for (61).  $\square$

**Lemma 12.13** *If a trigon in  $\Lambda$  has a (23)-corner, then we are in SITUATION SCC, and it must be a (23), (45), (61)-trigon consisting of  $\overline{34}, \overline{56}, \overline{12}$ -edges.*

**Proof** This is a combination of Lemmas 12.11, 12.12 and 12.10.  $\square$

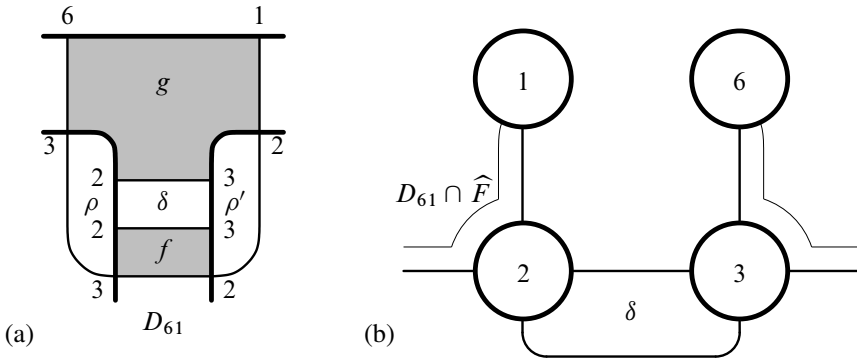

Figure 34

### 12.1 Special vertices for Case D of Theorem 11.1

As  $\Lambda$  contains no 2-ESCs there may be no more than 7 edges that are mutually parallel.

Since  $t = 6$ , Lemmas 5.11 and 5.14 imply there exists a vertex  $v$  of  $\Lambda$  of type  $[6\Delta - 5, 4]$ ,  $[6\Delta - 4, 1]$  or  $[6\Delta - 3]$ . We refer to a corner at  $v$  that is not incident to a bigon of  $\Lambda$  as a *gap*. Thus there are at most 5 gaps at  $v$ . We will argue by contradiction, in each case showing that there must be more gaps than specified.

By Corollary 12.9, each of the  $\Delta$  corners (4561) around  $v$  must have a gap. By Corollary 12.6 at least  $\Delta - 2$  (23)-corners must have gaps as well. Thus there must be at least  $2\Delta - 2$  gaps. If  $\Delta \geq 4$  then there must be at least 6 gaps; a contradiction. Hence  $\Delta = 3$ .

When  $\Delta = 3$  the vertex  $v$  is of type  $[13, 4]$ ,  $[14, 1]$ , or  $[15]$ . Type  $[15]$  is prohibited since using  $\Delta = 3$  in the argument of the preceding paragraph implies  $v$  must have at least 4 gaps. We eliminate the remaining types in the following subsections.

#### 12.2 Vertex $v$ is of type $[14, 1]$

There are at most 4 gaps at  $v$ . By Corollary 12.9, each of the three sequences of the labels (4561) must have a gap. By Corollary 12.6 one (23)-corner must be a gap. Thus there are two sequence of bigons with a (1234)-corner. Therefore by the following Lemma 12.14 there must be a gap at the remaining (12)-corner or (34)-corner at  $v$ . This however requires 5 gaps at  $v$ .

**Lemma 12.14** *If there are two (23)–corners at a vertex  $x$  that belong to bigons of  $\Lambda$ , then at the other (23)–corner of  $x$  one of the adjacent corners does not belong to a bigon of  $\Lambda$ .*

**Proof** Assume two (23)–corners at  $x$  belong to bigons of  $\Lambda$ . By [Lemma 12.5](#) these bigons are SCs,  $\sigma_1, \sigma_2$  (we assume they are distinct else a similar argument holds). Assume there is another (23)–corner at  $x$  such that there is a bigon incident to its adjacent (12)–corner (if the (34)–corner, the same argument applies). Let  $e_2, e_3$  be the edges of  $G_Q$  incident to this (23)–corner (where  $e_2$  has label 2 at  $x$ ). By [Lemma 12.7](#),  $e_2$  is either a  $\overline{23}$ –edge or a  $\overline{25}$ –edge of  $\Lambda$ . As an edge of  $G_F$ ,  $e_2$  must lie outside of  $B_{12,34}$  (if it were a  $\overline{23}$ –edge, then it along with edges of  $\sigma_1, \sigma_2$  would, by [Lemma 12.3](#), violate [Lemma 8.15](#) or [Lemma 12.15](#)). But then  $e_3$  as an edge in  $G_F$  must lie inside  $B_{12,34}$  (by the ordering of the labels around vertices 2,3 of  $G_F$  coming from (23)–Scharleman cycle of  $\tau$  and  $e_2, e_3$ ). If  $e_3$  is also in a bigon of  $\Lambda$ , then it must be a  $\overline{23}$ –edge (by [Lemma 12.7](#) and since vertex 6 does not lie in  $B_{12,34}$ ). As  $e_3$  lies in  $B_{12,34}$ , it must be parallel to edges of  $\sigma_1, \sigma_2$ , which by [Lemma 12.3](#) would violate [Lemma 8.15](#) or [Lemma 12.15](#).  $\square$

### 12.3 Vertex $v$ is of type [13, 4]

There are at most 5 gaps around  $v$ ; at least 4 of these gap corners belong to trigons of  $\Lambda$ ; there is at most one corner that may belong to neither a bigon nor trigon of  $\Lambda$ . Note that this implies that every edge incident to  $v$  lies in  $\Lambda$ .

By [Corollary 12.9](#) each of the three (4561)–corner sequences around  $v$  must be missing a bigon. Thus among the three (1234)–corner sequences, only two may be missing a bigon. Let us distinguish these three (1234)–corner sequences around  $v$  by marking them as  $c, c'$  and  $c''$ . Furthermore let  $e_i, e'_i$  and  $e''_i$  be the edge of  $\Lambda$  incident to  $c, c'$  and  $c''$  respectively at the label  $i$  for  $i = 1, 2, 3, 4$ .

Note that there can be no (23), (45), (61)–trigon consisting of  $\overline{34}, \overline{56}, \overline{12}$ –edges incident to a (23)–corner of the vertex  $v$ . Because there would have to be a bigon on one side of this corner at  $v$ . This bigon would be a (12)– or (34)–SC contradicting [Lemma 12.7](#).

By [Corollary 12.6](#) at least one (23)–corner is a gap, say the one at  $c$ . Since there is not a trigon with a (23)–corner by [Lemma 12.13](#), only  $c$  may have a gap at its (23)–corner. Thus the two (23)–corners at  $c'$  and  $c''$  have bigons. These bigon faces are SCs by [Lemma 12.5](#). By [Lemmas 12.3, 8.15](#) and [12.15](#), neither  $e_2$  nor  $e_3$  may be parallel on  $G_F$  to one of the  $\overline{23}$ –edges in  $\partial B_{12,34}$ . Thus the labeling around vertices 2, 3 of  $G_F$  forces one edge to be a spanning arc of  $B_{12,34}$  and the other to lie outside  $B_{12,34}$  and

not parallel into  $\partial B_{12,34}$ . Without loss of generality, let us assume  $e_3$  is a spanning arc of  $B_{12,34}$  and thus is a  $\overline{34}$ -edge (by the Parity Rule of Section 3).

Since  $e_3$  is a  $\overline{34}$ -edge, the adjacent (34)-corner cannot belong to a bigon. Otherwise such a bigon would be a Black (34)-SC. By Lemma 12.7 this does not occur. Thus the adjacent (34)-corner must belong to a trigon  $g$ . Since the edge  $e_3$  of this Black trigon  $g$  is a spanning arc of  $B_{12,34}$ ,  $g$  lies in the solid torus of parallelism of  $A_{12,34}$  into  $B_{12,34}$ . Hence  $g$  has a second (34)-corner and a (12)-corner. (It cannot be a (34)-SC as  $A_{12,34}$  is parallel into  $B_{12,34}$ .) Moreover edge  $e_4$  of  $g$  is a  $\overline{14}$ -edge. Since  $e_4$  is contained in  $B_{12,34}$ , it belongs to one of the two  $\overline{14}$ -edge classes of  $\partial B_{12,34}$ .

Because there are at most 5 corners of  $v$  without bigons, the two (1234)-corner sequences at  $c'$  and  $c''$  must entirely belong to bigons and thus form ESCs. Furthermore, the (12)-corner at  $c$  must be a bigon  $h$  in  $\Lambda$ . It is either a (12),(34)-bigon or a (12),(56)-bigon.

Assume  $h$  is a (12),(34)-bigon. At  $v$  we have identified three  $\overline{41}$ -edges incident to  $v$  at label 4,  $e_4, e'_4, e''_4$ , and three  $\overline{23}$ -edges incident to  $v$  at label 2. By Lemma 8.15, the  $\overline{41}$ -edges, as well as the  $\overline{23}$ -edges, must be in distinct edge classes in  $G_F$ . To a neighborhood of the union of  $B_{12,34}$  and these  $\overline{41}$ -edges and  $\overline{23}$ -edges, add any complementary disk components of  $\widehat{F}$ . The resulting surface  $S$  is a 4-punctured sphere in  $\widehat{F}$ . This immediately rules out SITUATION SCC as there would have to be a separating Black meridian disjoint from  $S$ . We assume SITUATION NO SCC. As  $e_4$  is parallel to one of the  $\overline{41}$ -edges of  $\partial B_{12,34}$ , it must be that  $e'_4$ , say, is not in one of the edge classes of  $\partial B_{12,34}$ . By Lemma 12.3, there must be a (12),(34)-bigon  $f$  of  $\tau$  and (12),(34)-bigon  $f'$  containing  $e'_4$  such that the  $\overline{23}$ -edges of  $f, f'$  are parallel but the  $\overline{41}$ -edges are not. Banding  $f, f'$  together along the parallelism of the  $\overline{23}$ -edges in  $G_F$ , along with the corresponding rectangles along the boundary of the knot exterior, gives a Black disks  $D'$  whose boundary on  $\widehat{F}$  is the union of the  $\overline{41}$ -edges of  $f, f'$ . This disk can be taken disjoint from  $K$ , and from the Möbius bands formed from  $\sigma$  and from the (23)-SC of  $\tau$ . Thus  $\partial D'$  must be separating in  $\widehat{F}$  (else we can form a Klein bottle or projective plane with these Möbius bands). But  $\partial D'$  can be isotoped to  $\partial S$ , contradicting the fact that it is separating.

Thus we may assume  $h$  is a (12),(56)-bigon. This immediately rules out SITUATION SCC (vertices 2, 5 would have to be separated). Again let  $e_4, e'_4, e''_4$  be the  $\overline{41}$ -edges incident to  $v$  with label 4. By Lemma 8.15, one of these (not  $e_4$ ), say  $e'_4$ , is not parallel to either of the  $\overline{41}$ -edges of  $\partial B_{12,34}$ . By Lemma 12.3, there must be a (12),(34)-bigon,  $f$ , of  $\tau$  and a (12),(34)-bigon,  $f'$ , containing  $e'_4$  whose  $\overline{23}$ -edges are parallel but whose  $\overline{41}$ -edges are not. Banding  $f, f'$  along the parallelism of their  $\overline{23}$ -edges as above gives a Black disk  $D'$  which is disjoint from the Möbius bands formed from  $\sigma$

and from  $\tau$ . Thus  $\partial D'$  must be separating in  $\widehat{F}$ . On the other hand,  $\partial D'$  can be isotoped to the boundary of the essential 4-punctured sphere formed from a neighborhood in  $\widehat{F}$  of the  $2\overline{5}$ -edge in  $h$ ,  $e'_4$ ,  $\sigma$  and  $B_{12,34}$ ; hence, it cannot be separating.

This completes the proof of Proposition 12.1. □

### 12.4 A generalization of Lemma 8.15 to $G_{F^*}$

We finish with a generalization of Lemma 8.15 that is needed for this section as well for Section 18.

**Lemma 12.15** *Let  $D$  be a meridian disk of  $\widehat{F}$  disjoint from  $Q$  and  $K$  and  $F^*$  be  $\widehat{F}$  surgered along  $D$  (hence is either one or two tori). Let  $G_{F^*}$  be the induced graph on  $F^*$ . There cannot be parallel edges of  $G_{F^*}$  that are incident to a vertex at the same label.*

**Proof** Let  $e, e'$  be parallel edges on  $G_{F^*}$  incident to a vertex  $v$  of  $G_{F^*}$  with the same label. If there are no monogons (1-sided faces) of  $G_{F^*}$  in the parallelism between these two edges, then the proof of Lemma 8.15 directly applies (after possibly surgering away simple closed curves of intersection). But the graph  $G_{F^*}$  may contain monogons even though  $G_F$  does not. Any monogon of  $G_{F^*}$  must contain at least one impression of  $D$ . In particular, there may be at most two innermost monogons of  $G_{F^*}$ .

**Claim 12.16** *Any monogon of  $G_{F^*}$  must be innermost.*

**Proof** If there is a noninnermost monogon of  $G_{F^*}$ , then there is one that appears as one in Figure 35. Each of these configurations gives a long disk<sup>1</sup> for  $K$  as a knot in  $S^3$ , contradicting its thinness there. □

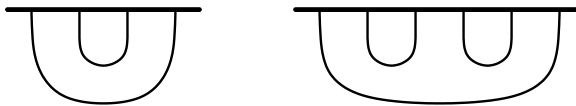

Figure 35

**Claim 12.17** *If there are monogons of  $G_{F^*}$  in the parallelism between  $e$  and  $e'$ , then there are exactly two and they appear as in Figure 36(a).*

<sup>1</sup>See Lemma 15.2 here or [1, Lemma 2.2 and Figure 1] for the concept of a long disk.

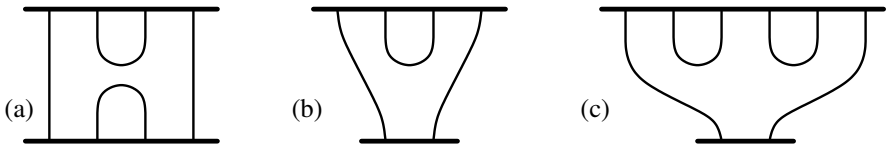

Figure 36

**Proof** Since there may be only two monogons and they are not nested, there are three possible configurations for monogons between parallel edges. These are shown in Figure 36(a), (b), (c). Configurations (b) and (c) give lopsided bigons<sup>2</sup> for  $K$  as a knot in  $S^3$ , contradicting its thinness there.  $\square$

So we may assume there are two monogons as in Figure 36(a) among the parallel edges between  $e$  and  $e'$ . Note that  $e$  and  $e'$  have the same label pairs. Abstractly band the monogons together as in Figure 37 to take advantage of the arguments of [16].

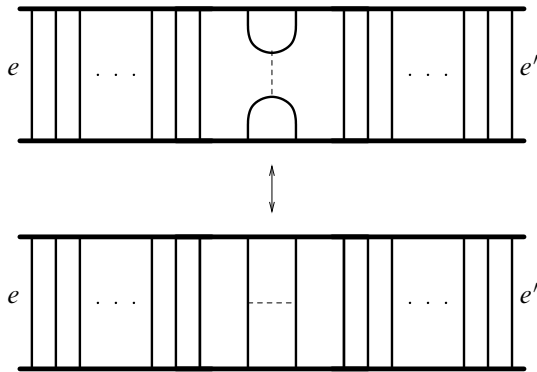

Figure 37

We employ the notation of [16], substituting  $F^* = P_\alpha$  and  $Q = P_\beta$ . We set  $n_\beta = |K \cap \widehat{Q}|$  and may assume  $n_\beta + 1$  is the number of arcs from  $e$  to  $e'$ . Let  $A_m$  and  $A_{m+1}$  be the arcs formed from banding the two monogons together,  $1 < m < n_\beta$ . (Since  $n_\beta$  is even, we have  $n_\beta + 1$  arcs, and neither  $A_m$  nor  $A_{m+1}$  is  $e$  or  $e'$ , then we may relabel and take our  $n_\beta$  parallel arcs so that neither  $A_m$  nor  $A_{m+1}$  is outermost among these  $n_\beta$  arcs.) Let  $A'$  and  $A''$  be the arcs of the original monogons.

We first assume the vertices of  $G_{F^*}$  connected by  $e, e'$  have the same parity (are parallel). Using  $A_m, A_{m+1}$  in place of  $A', A''$ , we apply the arguments in [16, Section 5] in

<sup>2</sup>See Lemma 15.2 here or the last two paragraphs of the proof of [1, Lemma 6.15] for the concept of a lopsided bigon.

the case (1)  $\epsilon = -1$ . These show that these edges form an ESC on  $G_{F^*}$  which we may assume is centered about the edges  $A_m, A_{m+1}$  that form a SC (else  $S^3$  has an  $RP^3$  summand). The edges of this ESC other than  $A_m, A_{m+1}$  then come in pairs, forming disjoint simple closed curves on  $\widehat{Q}$ . Some innermost pair of these edges then bounds a disk in  $G_Q$  (since the edges  $A', A''$  connect the remaining vertices  $\{m, m + 1\}$ ). The argument of [16], after possibly surgering away simple closed curves of intersection, implies that  $K$  is a  $(1, 2)$ -cable knot, contradicting its hyperbolicity.

We next assume the vertices of  $G_{F^*}$  connected by  $e, e'$  have the opposite parity. Again, using  $A_m, A_{m+1}$  in place of  $A', A''$ , we apply the arguments in [16, Section 5] in the case (2)  $\epsilon = 1$ . The map  $\pi$  partitions the arcs  $A_1, \dots, A_{n_\beta}$  into orbits of equal cardinality of at least 2. Since the surface  $\widehat{Q}$  is separating, the map  $\pi$  must have an even number of orbits ( $i \equiv \pi(i) \pmod 2$  by the Parity Rule). In particular,  $A_m$  and  $A_{m+1}$  belong to different orbits. Each orbit  $\theta$ , other than the ones containing  $A_m$  and  $A_{m+1}$ , gives rise to a simple closed curve  $C_\theta$  on  $\widehat{Q}$ . Exchanging  $A_m, A_{m+1}$  for  $A', A''$  merges the two orbits containing vertices  $m, m + 1$ , giving rise to a single simple closed curve  $C'$  on  $\widehat{Q}$ . All of these simple closed curves are mutually disjoint on  $\widehat{Q}$ .

If there is a simple closed curve other than  $C'$  (ie if there are more than 2 orbits of  $\pi$ ) then there is one that is innermost on  $\widehat{Q}$ ; let this be the  $C_\theta$  that is used to complete the proof in [16].

If  $C'$  is the only simple closed curve then  $e$  and  $e'$  must be parallel on  $G_Q$ , bounding a disk in  $G_Q$  whose interior is disjoint from  $C'$ . The argument of [16] in case (1) (above) applies to show that  $K$  is a  $(1,2)$ -cable knot, a contradiction. □

### 13 When $t = 4$ and no SCC

In this section we assume that  $t = 4$  and that we are in SITUATION NO SCC.

We use configurations of bigons and trigons at a special vertex of  $\Lambda$  to either produce a Dyck’s surface in  $M$  or to find a new genus two Heegaard splitting of  $M$  with respect to which  $K$  has bridge number 0 or 1 (ie making  $t = 0$  or  $t = 2$ ).

$\Lambda$  cannot have 9 mutually parallel edges by Lemma 16.9. Therefore by Lemmas 5.12 and 5.14 there exists a special vertex  $x$  in  $\Lambda$  of type  $[4\Delta - 3]$ ,  $[4\Delta - 4, 1]$  or  $[4\Delta - 5, 4]$ . Recall from Section 5.3 that a special vertex,  $x$ , of  $\Lambda$  is of type  $[a, b]$  if, of the  $4\Delta$  corners at  $x$ ,  $a$  belong to bigons of  $\Lambda$  and  $b$  belong to trigons of  $\Lambda$ . Nothing is known of the faces to which the remaining corners belong, indeed these faces might not even belong to  $\Lambda$ . We refer to the corners of  $x$  which belong to these latter faces as *true*



gaps at  $x$ . Thus all but  $a + b$  corners of  $x$  are true gaps. We refer to those corners at  $x$  as gaps which are not known to belong to bigons of  $\Lambda$  at  $x$  (ie the true gaps as well as the  $b$  corners that belong to trigons of  $\Lambda$ ). Thus, all but  $a$  corners at  $x$  are gaps. In sequence around  $x$  we label the faces in  $\Lambda$  as follows: B: bigon, S: an SC, M: mixed bigon, T: trigon. A mixed bigon of  $\Lambda$  is one that is not an SC. We label as g: gap, G: true gap. If ABC and XYZ are two disjoint subsequences of faces around a vertex, we write ABC+XYZ to indicate coherent ordering (orientation) without assuming relative positions.

### 13.1 Main argument for $t = 4$ and SITUATION NO SCC

**Lemma 13.1** *If  $t = 4$  and SITUATION NO SCC then either  $M$  contains a Dyck's surface or  $\Delta \leq 3$ .*

**Proof** Assume  $t = 4$  and SITUATION NO SCC, that  $\Delta \geq 4$  and  $M$  does not contain a Dyck's surface. As mentioned above, Lemma 16.9 along with Lemmas 5.12 and 5.14 guarantee that there exists a special vertex  $x$  in  $\Lambda$  of type  $[4\Delta - 3]$ ,  $[4\Delta - 4, 1]$  or  $[4\Delta - 5, 4]$ .

**$x$  has type  $[4\Delta - 3]$**  Since  $\Delta \geq 4$ , there must be five consecutive bigons around  $x$ . This contradicts Lemma 16.9.

**$x$  has type  $[4\Delta - 4, 1]$**  First assume there are 4 consecutive bigons at  $x$ . By Lemma 16.9, these must be flanked by two gaps. By relabeling we may assume these four bigons contain a (1234)–ESC. By Lemma 16.7 all bigons or trigons of  $\Lambda$  at (23)–corners must actually be (23)–SCs; furthermore, the edges of any two such bigons must come in parallel pairs on  $G_F$ . By Lemma 8.15 then, all but at most two (23)–corners at  $x$  are (true) gaps. As there are four gaps at  $x$ , two of which are contiguous to the four consecutive bigons above and hence are not (23)–corners,  $\Delta = 4$ . By Lemma 16.9 the positions of these two remaining gaps at (23)–corners is forced and there must exist a (3412)–ESC at  $x$ . But then there are four (41)–SCs at  $x$ . Together Lemmas 16.7 and 8.15 provide a contradiction.

Since there cannot be four consecutive bigons at  $x$ , we must have  $\Delta = 4$  and there must be four triples of bigons at  $x$  separated by single gaps. Since one of the gaps is actually a trigon, Lemma 15.5 implies that the adjacent triples of bigons are ESCs. Then Lemma 16.7 implies all four triples are ESCs. Since their SCs all have the same labels, Lemmas 16.7 and 8.15 provide a contradiction.

**$x$  has type  $[4\Delta - 5, 4]$**  If there is a, say, (1234)–ESC, then it must be adjacent to a true gap by Lemma 16.8. By Lemmas 16.7 and 8.15 there must also be a true gap at some (23)–corner, but  $x$  has only one true gap. Hence there is no ESC at  $x$ .

Since  $\Delta \geq 4$  and there is no ESC, there must appear BgSMSgB around  $x$ . Because there is only one true gap at  $x$ , this sequence is actually either BTSMSTB or BTSMsGB (or its reverse). Then, since there is only one true gap, applying Lemma 15.6 twice for the former and once for the latter implies there are at most 10 corners around  $x$ , a contradiction.  $\square$

**Theorem 13.2** *If  $\Delta \geq 3$ ,  $t = 4$  and SITUATION NO SCC then  $M$  contains a Dyck’s surface.*

**Proof** Assume  $t = 4$  and SITUATION NO SCC, that  $\Delta \geq 3$  and  $M$  does not contain a Dyck’s surface. By Lemma 13.1 and our hypothesis,  $\Delta = 3$ . But then Theorems 13.6 and 13.7 contradict each other.  $\square$

### 13.2 The lemmas to complete $t = 4$ and SITUATION NO SCC

The goal of this section is to finish the proof of Theorem 13.2 by proving Theorems 13.6 and 13.7. So for this subsection we assume  $t = 4$ , SITUATION NO SCC,  $M$  contains no Dyck’s surface and  $\Delta = 3$ . Thus a special vertex of  $\Lambda$  is one of type [9], [8, 1] or [7, 4].

**Lemma 13.3** *If  $\Delta = 3$  then a special vertex  $x$  of  $\Lambda$  cannot have BBBB.*

**Proof** By Lemma 16.9 there cannot be five bigons in a row. By Lemma 16.14 there cannot be a trigon adjacent to these four bigons. Hence four consecutive bigons must be flanked by true gaps. Thus, assuming a special vertex  $x$  of  $\Lambda$  has BBBB, it has type [9] or [8, 1].

Up to relabeling, we may assume for this vertex we have:

1	2	3	4	1	2	3	4	1	2	3	4
G	M	S	M	S	G						G

By Lemma 16.7 the remaining two (23)–corners each have a G or S and the remaining (41)–corner has a G, S, or Scharlemann cycle T. Lemmas 8.15 and 16.7 imply that one of these two (23)–corners must have the last G so that the (41)–corner has an S or a Scharlemann cycle T:

	1	2	3	4	1	2	3	4	1	2	3	4
(1)	G	M	S	M	S	G	S				G	G
(2)	G	M	S	M	S	G	G				S	G

If  $x$  has type [9], then the remaining corners must be bigons. In line (2) above there must be five consecutive bigons, contrary to Lemma 16.9. In line (1) above the three bigons to the left of the G (at (23)) form an ESC with labeling contrary to Lemma 16.10.

Thus  $x$  has type [8, 1] and there must be a T. First, assume this T is at the remaining (41)–corner, and hence is an SC. Then Lemma 16.15 contradicts both lines (1) and (2) above (where the roles of labels 2, 3 and 4, 1 are interchanged). Thus we assume this (41)–corner must belong to an S. Lemma 16.10 implies that the T must be adjacent to this S. Since the bigon to the other side of this S must be an M, we have a FESC whose presence violates Lemma 16.13. □

**Theorem 13.4** *If  $\Delta = 3$  then a special vertex  $x$  of  $\Lambda$  cannot have an ESC.*

**Proof** Assume there is an ESC around  $x$ . By Lemma 16.8 this ESC must be adjacent to a true gap. WLOG we assume the ESC is on the corner (1234) with the true gap to the left and, by Lemma 13.3, a gap to the right.

**Case I** The vertex  $x$  has type [7, 4].

By Lemma 16.7, all three (23) corners around  $x$  have SCs whose edges are parallel to that of the ESC. This gives a contradiction via Lemma 8.15.

**Case II** The vertex  $x$  has type [8, 1] or [9].

Up to relabeling we may assume we have one of the following:

	1	2	3	4	1	2	3	4	1	2	3	4	
(1)	G	M	S	M	G								G
(2)	G	M	S	M	T								G

By Lemmas 16.7 and 8.15 one of the remaining (23)–corners has a G and the other has an S. (If both (23)–corners have a true gap then we are in (2) above, and the remaining corners belong to bigons of  $\Lambda$ . Then by Lemma 16.7 there is an ESC containing a (41)–SC. This contradicts Lemma 16.10.) Furthermore Lemma 16.7 implies the remaining (41)–corner has a G, S, or Scharlemann cycle T.

If  $x$  is as in line (1) then one of the remaining (23)–corners must take the last G. This gives a run of five yet to be accounted corners. Without one of the last corners being a T, there would be four consecutive bigons contrary to Lemma 13.3. So  $x$  cannot have type [9] and must have type [8, 1]. Since the remaining (23)–corner in this run of five must be an S, the two possible placements of the T give configurations GMSTSMG and GMSMTMG (or GMTSMG) overlapping the original GMSMG on one G. The former is forbidden by Lemma 15.12. The latter may be seen as a case of line (2).

We may now assume  $x$  is as in line (2). Note that the pictured T is a Scharlemann cycle by Lemma 16.7. If the remaining (41)–corner has an S then Lemma 13.3 implies that the final G must be between this S and the S at whichever of the two remaining (23)–corners. In these two cases, the types of bigons may be determined at enough of the remaining corners for Lemma 16.15 to apply and be contradicted by the number of  $\overline{23}$ –edges at the vertex. Therefore the remaining (41)–corner has a G. Whichever of the remaining (23)–corners gets an S must then be flanked by M bigons and all remaining bigons must be Black. Hence we must have the configuration  $gMSMgMSMgBgB$ , which is forbidden by Lemma 16.12.  $\square$

**Theorem 13.5** *If  $\Delta = 3$  then at a special vertex  $x$  of  $\Lambda$  a triple of bigons must be adjacent to a true gap.*

**Proof** Assume otherwise. Then by Lemma 13.3 we must have TBBBT at  $x$ . By Lemma 16.8 we have TSMST. Hence the vertex  $x$  must have type  $[7, 4]$ . By symmetry we may assume we do not have the true gap immediately to the right, so that we have either TSMSTB or TSMSTT. We then have the following possible configurations at  $x$ :

(1)		B	T	S	M	S	T	B	
(2)		B	T	S	M	S	T	T	
(3)		T	T	S	M	S	T	T	
(4)		G	T	S	M	S	T	B	
(5)		G	T	S	M	S	T	T	

Lines (1) and (4) contradict Lemma 15.6 (too many true gaps). Note, as in all of these lemmas, Lemma 15.6 applies equally well to the reverse ordering, BTSM.

In line (2), the B must be an S by Lemma 15.6. There are three remaining corners of the same color as the M shown. Lemmas 15.10, 15.14 and 15.6 then imply the G must be adjacent to the newly placed S and the other two corners are filled with an M and the last T. Regardless of this last choice, the remaining two corners are both Ss (Lemma 15.2). Thus five corners of the same color have an S. The edge shared by the adjacent Ts is parallel to an edge of the M shown in line (2) by Lemmas 15.2 and 14.5. Now Lemma 16.1 applies providing a contradiction to Lemma 8.15.

In lines (3) and (5) there must be two more bigons the same color as the M shown. Lemma 15.14 implies each of these must be an M, but this contradicts Lemma 15.10.  $\square$

**Theorem 13.6** *If  $\Delta = 3$  then a special vertex  $x$  of  $\Lambda$  cannot contain a triple of bigons.*

**Proof** Assume there is BBB at the special vertex  $x$ . By Theorems 13.4 and 13.5, every BBB is an SMS adjacent to a gap. In particular, we have GSMS.

**Case I** The vertex  $x$  has type  $[7, 4]$ . Then by Lemma 13.3 we must have GSMST. Note that the true gap indicated is the only one at  $x$ . The FESC must be type I by Lemma 15.2. Lemma 15.6 implies we cannot have GSMSTB. Thus we must have GSMSTT. To the right of this there are 2, 1 or 0 Bs before the next T (Theorem 13.5).

**Case Ia** Assume we have GSMSTTBBT. If the BB are SM then we contradict Lemma 15.8. If the BB are MS then by Lemmas 15.6 and 15.8 the remaining three spots are filled with TMS. Yet this contradicts Lemma 15.10.

**Case Ib** Assume we have GSMSTTBT. The B is the same color as the M. Since three of the remaining four positions get a bigon, one of these must be the same color as the M too. This however contradicts Lemma 15.10 or 15.14.

**Case Ic** Assume we have GSMSTTT. Theorem 13.5 permits only two positions for the final T:

(1)	G	S	M	S	T	T	T		T				G
(2)	G	S	M	S	T	T	T			T			G

Theorem 13.4 labels the triple of bigons in line (1) as SMS. Now Lemma 15.6 gives a contradiction.

In line (2), the bigons to each side of this last T are the same color as the M. This contradicts Lemma 15.10 or 15.14.

**Case II** The vertex  $x$  has type  $[8, 1]$ .

Thus we have four gaps (one trigon and three true gaps) and by Lemma 13.3 we must have gSMSg (where at least one of these gaps is a true gap). By Lemma 16.17 we cannot have gSMSgSMSg. Thus, up to symmetry, we must have one of the following four configurations:

		1	2	3	4		1	2	3	4		1	2	3	4
(1)	g	S	M	S	g	g	S	M	S	g			g		g
(2)	g	S	M	S	g		g			g			g		g
(3)	g	S	M	S	g		g	S	M	S	g		g		g
(4)	g	S	M	S	g			g		g			g		g

In line (1), filling in the last two blanks with either MS or SM produces a contradiction to Lemma 17.1.

In line (2), by Lemma 15.5 the initial  $g$  must be  $G$  so that the  $T$  occurs at one of the remaining three. Lemmas 15.2 and 15.14 force configuration (i) below when the  $T$  is at the second gap. When the  $T$  is at the third gap, Lemmas 15.2, 15.14 and 17.1 force configurations (ii), (iii) and (iv) below. Lemma 15.5 determines the labelings of all the bigons but one if the  $T$  is at the last  $g$ , giving (v) below:

	1	2	3	4	1	2	3	4	1	2	3	4	
(i)	G	S	M	S	T	S	G	S	M	G	M	S	$\bar{g}$
(ii)	G	S	M	S	G	S	T	S	M	G	M	S	$\bar{g}$
(iii)	G	S	M	S	G	S	T	M	S	G	S	M	$\bar{g}$
(iv)	G	S	M	S	G	M	T	M	S	G	S	M	$\bar{g}$
(v)	G	S	M	S	G		G	S	M	T	M	S	$\bar{g}$

Lemma 16.1 (with the roles of 1, 2 and 3, 4 interchanged) applies to each of configurations (i), (ii) and (v), giving a contradiction to Lemma 8.15. (Notice that the  $T$  in line (v) is an SC.) For (iv), Lemma 17.1 implies that a neighborhood of the  $\overline{41}$ -edges of the MSGSM subconfiguration is a 1-punctured torus, and hence that the  $\overline{23}$ -edges of the (23)-Scharlemann cycle (bigon and trigon) lie in a 1-punctured torus. This contradicts Lemma 16.15. To eliminate (iii), consider the two (12)-SCs,  $S_1, S_2$ , in that configuration. The argument of Lemma 16.16 applied to the subconfigurations  $S_1MS$ ,  $SM$  and  $S_2$  (with labels 1, 2, 3, 4 relabeled 3, 4, 1, 2), shows that  $S_1, S_2$  are parallel bigons. Thus we can think of the subconfigurations  $S_1M, S_2T$  together as one FESC. That is, applying the argument of Lemma 15.13 to these faces and the (41),(23)-SCs of (iii) shows that three Möbius bands  $A_{41}, A_{23}, A_{12}$  corresponding to these Scharlemann cycle faces can be perturbed to be disjoint. But Lemma 8.11 contradicts that  $M$  does not contain a Dyck’s surface. We have eliminated configurations (i)–(v), and line (2) does not occur.

In line (3), by symmetry we may assume the second  $g$  (just to the left of the first blank) is actually  $T$  and the other  $g$  are all  $G$ . Then Lemma 15.6 implies that the first blank is an  $S$  and the contiguous FESC is of type I. Applying Lemma 15.10 to this FESC and the mixed bigon in the remaining SMS configuration contradicts Lemma 8.15.

In line (4) we examine where the  $T$  may go. It cannot be either of the first two gaps (at the (41)-corners) by Lemma 15.5. So without loss of generality assume the trigon is the third gap (at the (34)-corner). Now we have two cases according to whether the bigon between the trigon and fourth gap is  $M$  or  $S$ .

If it is  $M$ , then to the left of the trigon there must also be an  $M$ . Otherwise we must have  $MSTM$  contradicting Lemma 15.2. Thus around the trigon we have  $SMTM$ . But now the SCs of the SMS provide a configuration contrary to Lemma 16.15 (where the

(34)–corners and  $\overline{12}$ –edges play the role of the (23)–corners and  $\overline{41}$ –edges of the Lemma).

If it is S, then it is a (41)–SC and we can apply Lemma 17.1(4) to conclude we obtain MSTSGSM. But then Lemma 15.14 gives a contradiction.

**Case III** The vertex  $x$  has type [9].

Since there are no MSM and no string of four bigons, there is just one configuration:

1	2	3	4	1	2	3	4	1	2	3	4	
G	S	M	S	G	S	M	S	G	S	M	S	G

This configuration is forbidden by Lemma 16.1 and Lemma 8.15. □

**Theorem 13.7** *If  $\Delta = 3$ , then a special vertex  $x$  of  $\Lambda$  must contain a triple of bigons.*

**Proof** Assume there is no BBB at  $x$ . Then there can be neither ggg nor gg+gg at  $x$ , or else there would be a BBB at  $x$ .

Without loss of generality we may assume a (41)–corner of  $x$  has a G, a true gap. We will use this G to mark the beginning and end of the sequence of faces around  $x$  as follows:

1	2	3	4	1	2	3	4	1	2	3	4	
G												G

The light grey G at the end is a repeat of the initial G.

**Case I** The vertex has type [7, 4] and there exists TT.

We enumerate the possibilities for the placement of this pair up to symmetry:

	1	2	3	4	1	2	3	4	1	2	3	4
(1)	G	T	T									G
(2)	G		T	T								G
(3)	G			T	T							G
(4)	G				T	T						G
(5)	G					T	T					G

In each line two more Ts must be placed with the remaining being Bs. Any placement of these two Ts in lines (1) and (4) contradicts having no BBB. In line (2), having no BBB forces the placement of the remaining two Ts. One application of Lemma 15.5 to the bigons around the central T renders the following:

$$(2) \quad \overline{\text{G B T T S M T M S T B B G}}$$

But now a second application of Lemma 15.5 around the rightmost T gives a contradiction.

For line (5), one T must be among the leftmost four spots and the other must be in the middle of the rightmost five. Lemma 15.5 gives the labeling of these rightmost five as SMTMS. Note that this T is a Scharlemann cycle. The two possibilities for the leftmost four are: (i) BBTB and (ii) BTBB. Labeling (i) as MSTB contradicts Lemma 15.6 so it must be labeled as SMTB. But now the SMTM (reading right to left) along with the (12)–SC call upon Lemma 16.15 to contradict that there are two more  $\overline{34}$ –edges at  $x$ . Hence we must have (ii). Labeling it as BTMS forms MSTTSM which contradicts Lemma 15.8. Thus it must be labeled as BTSM giving us, by Lemma 15.6, the following configuration. Lemma 16.1 (with the roles of labels 1, 2 and 3, 4 interchanged) then gives three parallel edges that provide a contradiction to Lemma 8.15.

$$(5) \quad \overline{\text{G S T S M T T S M T M S G}}$$

For line (3) both remaining Ts must be on the right side, and there are three possible placements. The two bigons on the left are either MS or SM.

	1	2	3	4		1	2	3	4		1	2	3	4	
	G	M	S	T	T		T	S	M	T	M	S	G	(i)	
	G	M	S	T	T	S	M	T		T	M	S	G	(ii)	
(3)	G	M	S	T	T	M	S	T	B		T		G	(iii)	
	G	S	M	T	T		T	S	M	T	M	S	G	(iv)	
	G	S	M	T	T	S	M	T		T	M	S	G	(v)	
	G	S	M	T	T	S	M	T	M	S	T	S	G	(vi)	

For lines (i) and (iv), first apply Lemma 15.5 to get the pictured configurations, then note these contradict Lemma 15.6. To get the configuration for line (ii) apply Lemma 15.6. But this line contradicts Lemma 15.8. For line (iii), apply Lemma 15.8 to get the pictured configuration. This now contradicts Lemma 15.6.

For line (v) apply Lemma 15.6 twice to obtain the pictured configuration. Then Lemma 15.2 applied to the TSM adjacent to the leftmost T implies the leftmost T is a Scharlemann cycle. Lemma 14.5 shows that the  $\overline{34}$ –edges on either end of the FESC TSM are parallel in  $G_F$ . This parallelism allows us to apply the argument of Lemma 16.15 to the subconfiguration SMT on the left-hand side and the middle M (for the analog of SMTM) along with (34)–SC at the right. But then the five  $\overline{12}$ –edges incident to  $x$  contradict the conclusion of that argument.



For line (vi), apply [Lemma 15.5](#) and then [Lemma 15.6](#) to obtain the configuration shown. Furthermore, [Lemma 15.6](#) shows that the first T must be a Scharlemann cycle. [Lemma 16.1](#) then gives three parallel edges that provide a contradiction to [Lemma 8.15](#).

**Case II** The vertex has type [7, 4] and no TT.

**Case IIa** Assume there exists MST.

[Lemma 15.9](#) gives three configurations to consider:

	1	2	3	4	1	2	3	4	1	2	3	4	
(1)	G							B	T	M	S	T	G
(2)	G					B	T	M	S	T	S	G	
(3)	G				B	T	M	S	T	S	T	G	

Line (1) must have either TB or BT to the left of the labeled faces. In the former, since no TT, we then have BTBBTMSG. Each choice of MS or SM for the BB is incongruous with [Lemma 15.6](#). In the latter, the placement of the fourth T is forced and [Lemma 15.5](#) gives:

G	S	M	T	M	S	T	B	T	M	S	T	G
---	---	---	---	---	---	---	---	---	---	---	---	---

The MSTB here contradicts [Lemma 15.6](#) too.

In line (2), [Lemma 15.14](#) forces the B to be an M. Then [Lemmas 15.14](#) and [15.12](#) imply that the remaining (23) and (41) corners take the final two Ts. Hence the remaining three corners have bigons. Being adjacent to an M, the center (12) corner takes an S. [Lemma 15.6](#) now gives a contradiction.

In line (3) the placement of the fourth T is forced. [Lemma 15.5](#) then gives a labeling contrary to [Lemma 15.6](#).

**Case IIb** There exists no MST.

There must be BB, and it must be between the G and a T. Hence BB must be either GSMT or TMSG. This forces:

1	2	3	4	1	2	3	4	1	2	3	4	
G	S	M	T	B	T	B	T	B	T	M	S	G

If the left and the right B are both an S then we have the configuration of [Figure 38](#). [Lemma 17.1](#) shows that no pair of  $e_1, \dots, e_6$  are parallel on  $G_F$ . But [Lemma 16.4](#)

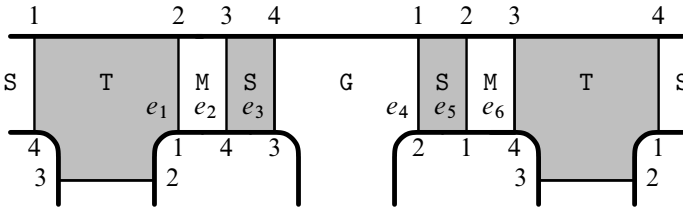

Figure 38

shows that either there is a parallelism among  $e_1, e_4$  and  $e_5$  or there is a parallelism among  $e_2, e_3$  and  $e_6$ . Hence WLOG the leftmost B is an M.

If at least one of the two remaining Bs is an M, then it will provide a fifth  $\overline{12}$ -edge incident to  $x$ . Then we will have a configuration contrary to Lemma 16.15. If the remaining Bs are each an S, then we may apply Lemma 17.1 to conclude that the  $\overline{34}$ -edges lie in a 3-punctured torus on  $\widehat{F}$  (since the  $\overline{12}$ -edges fill out a 1-punctured torus). This contradicts again Lemma 16.15.

**Case III** The vertex has type  $[8, 1]$ .

There are 8 bigons and 4 gaps. There cannot be gBg since this would imply the existence of BBB. Hence the gaps are equally spaced. Due to symmetry, we may designate any of these gaps to be the T and the others to be Gs; assume the T occurs at a  $(12)$ -corner of  $x$ . Apply Lemma 15.5 to label the two pairs of bigons around the T. If any of the remaining bigons are  $(12)$ -SCs, then the resulting configuration will contradict Lemma 16.15 (with too many  $\overline{34}$ -edges). This leaves the configuration shown in Figure 39.

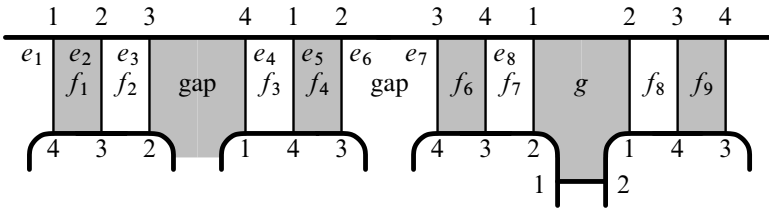

Figure 39

The faces  $f_1, \dots, f_6$  give the configuration and labeling in Figure 75, where  $f_5$  is now a gap. The remaining three bigons are labeled  $f_7, f_8, f_9$  and the trigon is labeled  $g$ .

Let  $A_{34}$  be the Black Möbius band arising from  $f_6$ . Let  $A_{12,34}$  be the Black annulus arising from  $f_1$  and  $f_4$ . By Lemma 17.1,  $A_{34}$  and  $A_{12,34}$  intersect transversely along

the (34)–arc of  $K$ . The subgraph of  $G_F$  arising from their edges is shown in Figure 79. As a neighborhood of this subgraph is a twice punctured torus, Lemma 17.1(1) implies its complement in  $\hat{F}$  is an annulus  $B\hat{F}$ . Furthermore, the (34)–arc of  $K$  has a bridge disk otherwise disjoint from  $A_{12} \cup A_{12,34}$  that meets this annulus along a single spanning arc. Hence cutting  $H_B$  open along  $N = N(A_{12} \cup A_{12,34})$  forms a solid torus  $\mathcal{T}$  on which  $B\hat{F}$  is a longitudinal annulus.

Since  $g$  is a properly embedded disk in  $\mathcal{T}$ , and  $\partial g$  crosses three times along the impressions of the 1–handle neighborhood of (12),  $g$  must be a meridional disk of  $\mathcal{T}$ . From this, one can see that two of the edges of  $g$  must be parallel into  $\partial B\hat{F}$  and the third runs from one component of  $\partial B\hat{F}$  to the other. In particular, the two edges that are boundary parallel cobound contiguous squares in  $G_{\hat{F}}$  as pictured in Figure 40(b). The labelings of the endpoints of edges  $e_7, e_8$  on vertices 3, 4 force one of  $e_3$  or  $e_4$  to lie in one of these squares in  $G_F$ . But this means that either  $e_3$  is parallel to one of  $e_2, e_6$  or  $e_4$  is parallel to one of  $e_1, e_5$ , contradicting Lemma 17.1.

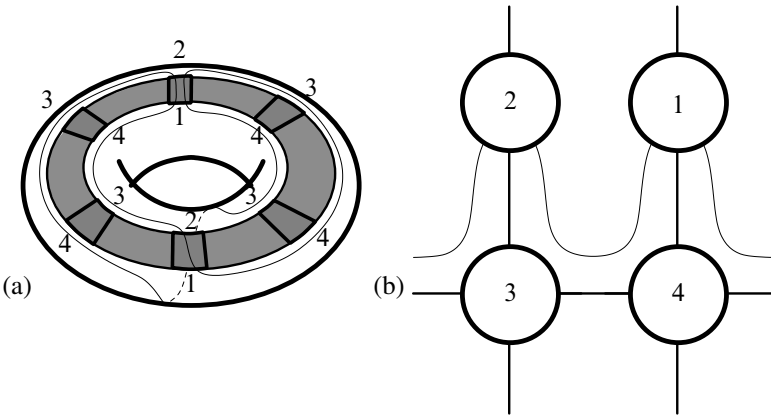

Figure 40

**Case IV** The vertex has type [9].

There must be a triple of bigons contrary to hypothesis. □

## 14 Thrice-punctured spheres, forked extended Scharlemann cycles and an application when $t = 4$

In this section we assume that  $t = 4$  and that we are in SITUATION NO SCC.

### 14.1 Thrice-punctured spheres in genus 2 handlebodies

Let  $P$  be an incompressible, separating, thrice-punctured sphere in a genus 2 handlebody  $H$ . Decompose  $H$  along  $P$  as  $H = M_1 \cup_P M_2$ . Since  $P$  is an incompressible surface in the handlebody  $H$ , it must be  $\partial$ -compressible. Assume  $P$  is  $\partial$ -compressible into  $M_2$ . It is easy to see that  $M_1$  and  $M_2$  are genus 2 handlebodies.

**Lemma 14.1**

$$M_2 = P \times [0, 1] \cup_{A_1 \cup A_2} \mathcal{T},$$

where  $P$  is identified with  $P \times \{0\}$ ,  $A_1$  and  $A_2$  are disjoint, nonisotopic, nonnull-homotopic annuli in  $P \times \{1\}$ , and either

- (1)  $\mathcal{T}$  is the union of two solid tori,  $\mathcal{T}_1$  and  $\mathcal{T}_2$ , and  $A_i \subset \partial\mathcal{T}_i$  is incompressible for each  $i = 1, 2$ ; or,
- (2)  $\mathcal{T}$  is a solid torus and  $A_1 \cup A_2 \subset \partial\mathcal{T}$  is incompressible.

In either case, if  $A_i$  is not longitudinal in  $\mathcal{T}$  ( $\mathcal{T}_i$ ), then the component  $c_i$  of  $\partial P$  that is isotopic (through  $P \times [0, 1]$ ) to the core of  $A_i$  is primitive in  $M_1$ .

**Proof** Let  $\delta$  be a  $\partial$ -compressing disk for  $P$  in  $M_2$ . The  $\partial$ -compression of  $P$  along  $\delta$  yields  $A$ , an incompressible annulus or pair of annuli. Cutting  $M_2$  along  $\delta$  yields  $\mathcal{T}$ , either one or two solid tori, with  $A \subset \partial\mathcal{T}$ . In the case that  $A$  is a single annulus, then  $\mathcal{T}$  is a single solid torus. Reversing the compression along  $\delta$ , we see  $M_2 = P \times [0, 1] \cup_A \mathcal{T}$ . To get description (1) above, set  $\mathcal{T}_1 = \mathcal{T}$ ,  $A_1 = A$  and pick a second disjoint, essential annulus,  $A_2 \subset P \times \{1\}$  along which we attach a solid torus  $\mathcal{T}_2$  longitudinally (giving a trivial decomposition). Otherwise,  $A = A_1 \cup A_2$  and reversing the compression along  $\delta$  gives either (1) or (2).

To prove the final statement, collapse  $M_2$  along  $P \times [0, 1]$  to write  $H$  as  $M_1 \cup_{A_1 \cup A_2} \mathcal{T}$  and let  $c_i$  be the core of  $A_i$ .  $A_i$  must boundary compress in  $H$ , but if  $A_i$  is not longitudinal in  $\mathcal{T}$  such a compression can be taken disjoint from  $\text{Int } \mathcal{T}$ . This gives a meridian disk in  $M_1$  that marks  $c_i$  as primitive in  $M_1$ . □

### 14.2 Forked extended Scharlemann cycles

Consider a FESC  $\tau$  in  $G_Q$ . Up to relabeling vertices of  $G_F$  and  $G_Q$ , we may assume it is as illustrated in Figure 41(a). As shown, label the two Black faces  $f$  and  $g$ . Also label and orient the two edges  $\alpha$  and  $\beta$ . The subgraph of  $G_F$  induced by the edges of  $\tau$  then appears on  $\hat{F}$  as shown in Figure 41(b) or its mirror. We assume in this subsection that we are in SITUATION NO SCC, so that  $f, g$  are properly embedded

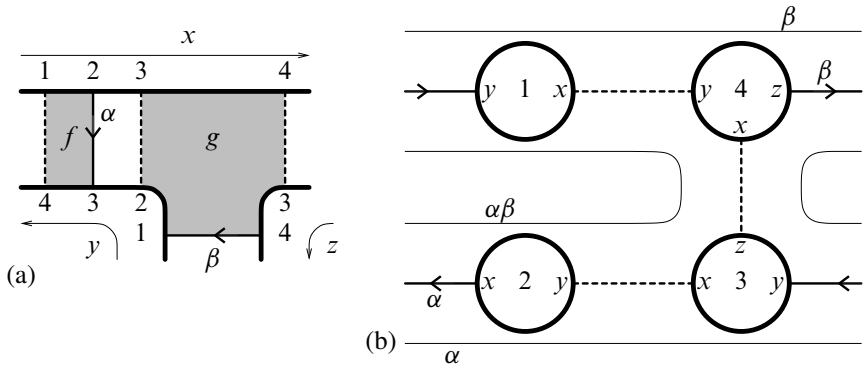

Figure 41

in  $H_B - N(K)$ . The White SC between  $f$  and  $g$  gives rise to a Möbius band,  $A_{23}$ , properly embedded in  $H_W$ .

Contracting the remaining three edges of  $\tau$  to a point  $*$  in this subgraph of  $G_F$ , we may view the edges  $\alpha$  and  $\beta$  as oriented loops. A neighborhood on  $\hat{F}$  of this subgraph of  $G_F$  induced by the edges of  $\tau$  is a 3-punctured sphere  $P'$ . Its boundary components may be identified with the loops  $\alpha$ ,  $\beta$  and  $\alpha\beta$  based at  $*$  also indicated in Figure 41(b). We aim to show that  $\beta$  bounds a disk in  $\hat{F}$  (Lemma 14.5).

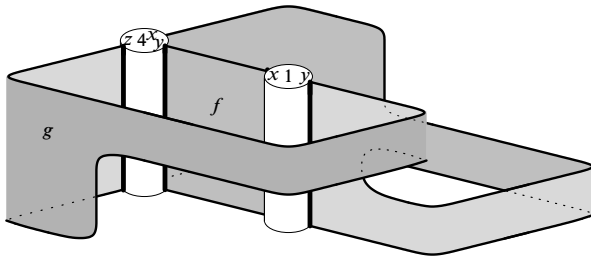

Figure 42

Form the genus 2 handlebody  $M_1 = N((12) \cup (34) \cup f \cup g) \subset H_B$ . Since  $\partial M_1 \cap \partial H_B = P'$ ,  $P = \partial M_1 \setminus \partial H_B$  is also a 3-punctured sphere. Thus we may write  $\partial M_1 = P \cup_{\{\alpha, \beta, \alpha\beta\}} P'$  and  $H_B = M_1 \cup_P M_2$ . Figure 41(a) gives instructions for the assembly of  $M_1$  which we may realize embedded in  $S^3$  as in Figure 42 with  $f$  and  $g$  thickened. Note that one may thus visualize  $M_1$  as the trefoil complement with the neighborhood of an unknotting tunnel removed:  $\alpha\beta$  is the cocore of the unknotting tunnel and  $\alpha$  and  $\beta$  result from a banding of  $\alpha\beta$  to itself. Recall that if  $O$  is a 3-manifold with boundary and  $\gamma$  is a curve in  $\partial O$ , then  $O\langle\gamma\rangle$  is  $O$  with a 2-handle attached along  $\gamma$ .

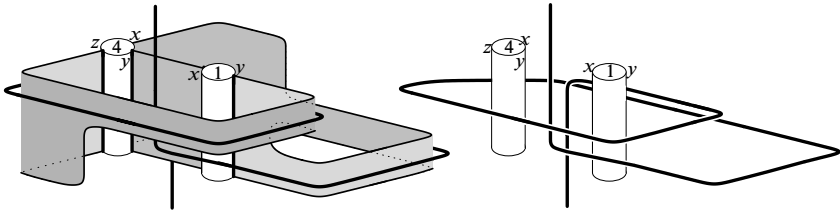

Figure 43

**Claim 14.2** *Let  $\alpha, \beta, \alpha\beta \subset M_1$  be as above.*

- (1)  $\alpha$  and  $\beta$  are primitive in  $M_1$ . Indeed  $M_1$  contains disjoint meridian disks, one intersecting  $\alpha$  once and disjoint from  $\beta$ , the other disjoint from  $\alpha$  and intersecting  $\beta$  once.
- (2) The arcs (12), (34) of  $K \cap M_1$  can be isotoped in  $M_1$ , fixing their endpoints, to arcs on  $\partial M_1$  that are disjoint from  $\alpha$  and  $\beta$  and that intersect  $\partial A_{23} \subset \partial M_1$  only in their endpoints (at vertices 2, 3 of  $G_F$ ). Furthermore, these arcs are incident to the same side of  $\partial A_{23}$  in  $\partial M_1$ .
- (3)  $M_1 \langle \alpha\beta \rangle$  is homeomorphic to the exterior of the trefoil. In particular,  $\alpha\beta$  is neither primitive nor cabled in  $\partial M_1$ .

**Proof** In Figures 41 and 42,  $\alpha$  and  $\beta$  encircle the two visible holes of the embedded genus 2 handlebody indicated by Figure 42. Let  $f, g$  be the black faces of  $\tau$  (Figure 41). Let  $e_1, e_2$  be disjoint properly embedded arcs in  $g$  parallel to the (34)–corners of  $g$  along vertices  $x, z$  (respectively) of  $G_Q$ . In  $M_1$ , a product neighborhood of  $e_1$  ( $e_2$ ) is a disk  $E_1$  ( $E_2$ ) in  $g \times I$  such that  $\partial E_1$  ( $\partial E_2$ ) intersects  $\alpha$  ( $\beta$ ) once but is disjoint from  $\beta$  ( $\alpha$ ).  $E_1$  and  $E_2$  verify (1).

Let  $E'_1$  be the disk component of  $E_1 \setminus e_1$  that is disjoint from  $\alpha$ . Band  $E'_1$  to the (34)–corner of  $g$  (to which  $e_1$  is parallel) to obtain a bridge disk  $D_{34}$  in  $M_1$  for the arc (34) of  $K$ .  $D_{34}$  is disjoint from both  $\alpha$  and  $\beta$  and intersects  $\partial A_{23}$  only in vertex 3 of  $G_F$ . Band the (12)–corner of  $f$  along  $f$  to  $D_{34}$  to obtain a bridge disk  $D_{12}$  of (12) of  $K$  in  $M_1$  which is disjoint from  $D_{34}$ ,  $\alpha$  and  $\beta$ ; and which intersects  $\partial A_{23}$  only at vertex 2.  $D_{12}, D_{34}$  guide the isotopies of (12), (34) described in (2).

Figure 43 shows that  $M_1 \langle \alpha\beta \rangle$  is homeomorphic to the exterior of the trefoil. Since this is neither a solid torus nor the connect sum of a solid torus and a lens space,  $\alpha\beta$  cannot be primitive or cabled in  $M_1$ . □

**Claim 14.3**  *$P$  is incompressible in  $M_1$ .*

**Proof** If  $P$  were compressible in  $M_1$ , then either  $\alpha$ ,  $\beta$  or  $\alpha\beta$  would bound a disk in  $M_1$ . [Claim 14.2](#) shows this cannot be.  $\square$

**Claim 14.4** *There is no properly embedded disk  $D$  in  $M_1$  such that  $\partial D$  meets  $P$  in a single essential arc.*

**Proof** Let  $D$  be a properly embedded disk in  $M_1$  such that  $\partial D \cap P$  is an essential arc in  $P$ .

First suppose  $D$  separates  $M_1$ , and let  $D_1, D_2$  be meridian disks of the two solid tori  $M_1 \setminus D$ . Both points of  $\partial D \cap \partial P$  belong to the same component of  $\gamma$  of  $\partial P$ . The other two components  $\gamma_1, \gamma_2$  of  $\partial P$  can be numbered so that  $\gamma_i \cap \partial D_j = \emptyset, \{i, j\} = \{1, 2\}$ . Hence  $\{\gamma_1, \gamma_2\} = \{\alpha, \beta\}$  and  $\gamma_i$  intersects  $D_i$  in a single point,  $i = 1, 2$ . But then  $\gamma (= \alpha\beta)$  intersects  $D_1$  (and  $D_2$ ) in a single point, contradicting the fact that  $M_1 \langle \alpha\beta \rangle$  is the trefoil exterior.

Next suppose  $D$  does not separate  $M_1$ . Let  $D'$  be a disk in  $M_1$  disjoint from  $D$  such that  $M_1 \setminus (D \cup D')$  is a 3-ball. If the two points of  $\partial D \cap \partial P$  belong to the same component of  $\partial P$ , then the other two components are disjoint from  $D$ , and hence must be  $\alpha$  and  $\beta$ . But then  $\alpha \cup \beta$  is disjoint from  $D$ , a contradiction. If the two points of  $\partial D \cap \partial P$  belong to different components of  $\partial P$ , then each of these components intersects  $D$  once, and hence they are  $\alpha$  and  $\beta$ , so the third component must be  $\alpha\beta$ . But this component is disjoint from  $D$ , contradicting the fact that  $M_1 \langle \alpha\beta \rangle$  is the trefoil exterior.  $\square$

**Lemma 14.5** *Assume we are in SITUATION NO SCC and there is a FESC centered (WLOG) about a (23)–SC. Then the two  $\overline{14}$ –edges are parallel in  $G_F$ .*

**Remark 14.6** We later use this lemma for an FESC put together by an MS and ST pair, where the S are parallel bigons (merging the SCs to one to give the faces of the FESC). We will also use this ([Lemma 15.6](#)) for an FESC put together by an ST and M where the leftmost edge of the ST is parallel to an edge of M.

**Proof** Assume there is a FESC  $\tau$ , without loss of generality as shown in [Figure 41](#). Construct  $M_1$  from  $f, g$  and write  $H_B = M_1 \cup_P M_2$  as above. Observe that  $\alpha$  is the boundary of the White Möbius band  $A_{23} \subset H_W$  arising from the (23)–SC between  $f$  and  $g$  on  $G_Q$ . If  $P$  is incompressible in  $H_B$ , then by [Claim 14.4](#) it must boundary compress in  $M_2$  and [Lemma 14.1](#) holds. If  $P$  compresses in  $H_B$ , it must compress in  $M_2$  by [Claim 14.3](#).

**Case I**  $P$  is incompressible in  $H_B$  and (1) of [Lemma 14.1](#) holds.

Then collapsing along  $P \times [0, 1]$ , we may write  $H_B = M_1 \cup_{(A_1 \cup A_2)} (\mathcal{T}_1 \cup \mathcal{T}_2)$ . The cores of the annuli must be isotopic to either  $\alpha, \beta$  or  $\alpha\beta$  in  $P$ . If the core,  $c$ , of either  $A_1$  or  $A_2$  is isotopic to  $\alpha\beta$  then, again by Lemma 14.1,  $c$  must be longitudinal in  $\mathcal{T}$  as  $\alpha\beta$  is not primitive in  $M_1$ . Thus if  $\alpha, \beta$  are not the cores of some  $A_1, A_2$  in the original decomposition, then we can replace the trivial decomposition along  $\alpha\beta$  with a trivial decomposition along  $\alpha$  or  $\beta$ . So we may assume that in  $P$ , the core of  $A_1$  is isotopic to  $\alpha$  and the core of  $A_2$  to  $\beta$ . By Claim 14.2(1), both  $\alpha$  and  $\beta$  are jointly primitive curves in  $M_1$ , and  $H'_B = N(A_{23}) \cup_\alpha M_1 \cup_{A_2} \mathcal{T}_2$  is a genus 2 handlebody. Since  $\alpha$  is a primitive curve in  $H_W \setminus A_{23}$ ,  $H'_W = (H_W \setminus A_{23}) \cup_\alpha \mathcal{T}_1$  is also a genus 2 handlebody. Together  $H'_B$  and  $H'_W$  form a new genus 2 Heegaard splitting for  $M$ .

Since (41) has a bridge disk  $D_{41}$  in  $H_W$  that is disjoint from  $A_{23}$  (Lemma 8.16), it continues to be bridge in  $H_W \setminus A_{23}$ . Moreover since  $D_{41}$  may be taken to be disjoint from  $\alpha$ ,  $D_{41}$  is a bridge disk for (41) in  $H'_W$ . By Claim 14.2, arcs (12),(34) can be isotoped to  $\partial H'_B$ , fixing their endpoints, so they intersect  $\partial A_{23}$  only at vertices 2, 3 (respectively) of  $G_F$  and are incident to the same side of  $\partial A_{23}$  (the isotopy in  $M_1$  is disjoint from  $\alpha, \beta$ ). Now we can write  $K$  as the union of two arcs (3412) that is a bridge arc of  $H'_W$  and (23) which is a bridge arc of  $H'_B$ : After isotoping (34),(12) to  $\partial H'_B$ , the arc (3412) is isotopic as a properly embedded arc in  $\partial H'_W$  to (41), which is bridge in  $H'_W$ . On the other hand, (23) can be isotoped as a properly embedded arc in  $H'_B$  to be a cocore of the annulus  $N(A_{23}) \cap \partial H_B$ . The primitivity of this annulus in  $H_B$  now describes (23) as a bridge arc in  $H'_B$ . That is,  $K$  is 1-bridge with respect to the splitting  $H'_W \cup H'_B$ . This contradicts that  $t = 4$ .

**Remark 14.7** If  $A_1$  is longitudinal in  $\mathcal{T}_1$  then  $\partial A_{23}$  will be primitive in  $H_B$  and the new splitting is gotten from the old by adding/removing a primitive Möbius band (in this case, adding  $\mathcal{T}_1$  to  $H_W$  is isotopic to the splitting where  $\mathcal{T}_1$  is not added). This is consistent with the proof of Theorem 2.6. If  $A_1$  is not longitudinal in  $\mathcal{T}_1$  then  $M$  is a Seifert fiber space over the 2-sphere with an exceptional fiber of order 2. In this case, we could find a vertical splitting with respect to which  $K$  has bridge number 0 by applying Lemma 8.3 to  $\mathcal{T}_1 \cup_\alpha A_{23}$ , a Seifert fiber space over the disk. This would then be consistent with the proof of Theorem 2.6.

**Case II**  $P$  is incompressible in  $H_B$  and (2) of Lemma 14.1 holds.

Collapsing along  $P \times [0, 1]$ , we view  $H_B$  as  $M_1 \cup_{A_1 \cup A_2} \mathcal{T}$ . Then the cores of  $A_1, A_2$  must be  $\alpha, \beta$  in  $M_1$ . This follows from Lemma 14.1 when  $A_1$  (hence  $A_2$  as well) is not longitudinal in  $\mathcal{T}$ , since  $\alpha\beta$  is not primitive in  $M_1$ . When  $A_1, A_2$  are longitudinal on  $\mathcal{T}$ , assume for contradiction that the core of  $A_1$  is  $\alpha\beta$ . As  $A_1 \cup A_2$  must be  $\partial$ -compressible in  $H_B$ , and  $\alpha\beta$  is not primitive in  $M_1$ , it must be that there is a meridian



disk for  $M_1$  that is disjoint from  $A_1$  and crossing the core of  $A_2$  once. But then we obtain the contradiction that the trefoil knot exterior,  $M_1\langle\alpha\beta\rangle$ , has compressible boundary.

So we may assume the core of  $A_1$  is  $\alpha$  and the core of  $A_2$  is  $\beta$  in  $M_1$ .

First consider the case where  $A_1$  runs  $n > 1$  times longitudinally around  $\mathcal{T}$ . There is an annulus  $B$  contained in  $\partial M_1$  which we may assume contains  $\partial A_{23}$  and  $A_1$  and that intersects  $K$  only at vertices 2, 3 of  $G_F$  (ie only along  $\partial A_{23}$ ). Let  $\mathcal{N}$  be  $N(B \cup A_{23} \cup \mathcal{T})$ . Then  $\mathcal{N}$  is a Seifert-fibered space over the disk with two exceptional fibers. Furthermore,  $K \cap \mathcal{N}$  lies as a cocore of the Möbius band  $A_{23}$  properly embedded in  $\mathcal{N}$ . Lemma 8.3 then gives a genus 2 splitting of  $M$  in which  $K$  is 0-bridge, a contradiction.

Finally consider the case where  $A_1, A_2$  are longitudinal in  $\mathcal{T}$ . By Claim 14.2, there are disjoint meridian disks  $D_1, D_2$  of  $M_1$  such that  $D_i$  intersects the core of  $A_i$  once and is disjoint from  $A_j$ , where  $\{i, j\} = \{1, 2\}$ . Then there is a disk  $D_3$  in  $\mathcal{T}$  such that  $D = D_1 \cup D_2 \cup D_3$  forms a meridian disk in  $H_B$  that intersects each of  $\alpha$  and  $\beta$  once. In particular,  $\alpha$  is primitive in  $H_B$ . Then  $H'_B = H_B \cup N(A_{23})$  is a genus 2 handlebody. Also  $H'_W = H_W - N(A_{23})$  is a genus 2 handlebody. Hence  $H'_B \cup H'_W$  is a genus 2 Heegaard splitting of  $M$ . We now show that  $K$  has bridge number one with respect to this splitting, thereby contradicting the assumption that  $t = 4$ . By Claim 14.2, arcs (12),(34) can be isotoped to  $\partial H_B$  so they intersect  $\partial A_{23}$  only at vertices 2, 3 (respectively) of  $G_F$  and are incident to the same side of  $\partial A_{23}$  (the isotopy in  $M_1$  is disjoint from  $\alpha, \beta$ ). Now we can write  $K$  as the union of two arcs, (3412) that is a bridge arc of  $H'_W$  and (23) which is a bridge arc of  $H'_B$ : After isotoping (34),(12) to  $\partial H_B$ , the arc (3412) is isotopic as a properly embedded arc in  $\partial H'_W$  to (41), which is bridge in  $H'_W$  (Lemma 8.16). On the other hand, (23) can be isotoped as a properly embedded arc in  $H'_B$  to be a cocore of the annulus  $N(A_{23}) \cap H_B$ . The primitivity of this annulus in  $H_B$  now describes (23) as a bridge arc in  $H'_B$ . That is,  $K$  is 1-bridge with respect to the splitting  $H'_W \cup H'_B$ .

**Case III**  $P$  is compressible.

Because  $P$  is not compressible into  $M_1$  by Claim 14.3, some component of  $\partial P$  bounds a disk  $D$  in  $M_2$ . The following then proves the lemma in this case.

**Claim 14.8** Assume there is a disk  $D$  properly embedded in  $H_B$  disjoint from  $M_1$  and with  $\partial D$  isotopic to  $\alpha, \beta$  or  $\alpha\beta$  in  $\partial H_B$ . Then  $\partial D$  must in fact be isotopic to  $\beta$ , and  $\beta$  must bound a disk in  $\partial H_B$ .

**Proof** If  $\partial D$  were isotopic to  $\alpha$ , then  $D \cup A_{23}$  forms an  $\mathbb{R}P^2$ ; this is a contradiction. If  $\partial D$  were  $\alpha\beta$ , then  $N(D) \cup_{\alpha\beta} M_1 = M_1\langle\alpha\beta\rangle$  is a trefoil complement embedded in

$H_B$  (Claim 14.2). Thus  $M_1\langle\alpha\beta\rangle$  must be contained in a 3–ball. By Lemma 3.3,  $\alpha$  bounds a disk in  $H_B$  or  $H_W$  which, as above, cannot occur. Thus  $\partial D$  is isotopic to  $\beta$ .

Now assume  $\beta$ , hence  $\partial D$ , is essential in  $\partial H_B$ . Let  $\mathcal{O}$  be the solid torus component of  $H_B - N(D)$  containing  $M_1$ . Let  $\mathcal{N}$  be  $\mathcal{O} \cup N(A_{23})$ . Using  $D$ , we may extend the isotopy from Claim 14.2(b) of arcs (12),(34), fixing their endpoints, to  $\partial\mathcal{O}$  so that the resulting arcs  $a, b$  are incident  $\partial A_{23}$  only at their endpoints and on the same side of  $\partial A_{23}$  (alternatively, Lemma 14.9 constructs such an isotopy). Thus  $K$  can be written as the union of two arcs: (34123),  $\mu$ . Arc (34123) is the union of the arcs  $a, b$  on  $\partial\mathcal{O}$ , the arc (41) of  $K \cap H_W$  and an arc on  $\partial N(A_{23}) - \mathcal{O}$  (a cocore of this annulus) running from vertex 2 to vertex 3. The arc  $\mu$  is a cocore of the annulus  $B = N(A_{23}) \cap \partial\mathcal{O}$  on  $\hat{F}$ . Note that (34123) is the union of the (41)–arc of  $K$  with two arcs on  $\partial\mathcal{N}$ . Pushing (34123) slightly into the exterior of  $\mathcal{N}$ , we have  $K \cap \mathcal{N} = \mu$ .

$B$  winds  $n > 0$  times around  $\mathcal{O}$ . First assume  $n > 1$ . Then  $\mathcal{N}$  is a Seifert fiber space over the disk with two exceptional fibers. Furthermore,  $\mu = K \cap \mathcal{N}$  is a cocore of the annulus  $B \subset \mathcal{N}$ , where  $B$  is vertical under the Seifert fibration. Lemma 8.3 applies to give a new genus 2 Heegaard splitting of  $M$  in which  $K$  is 0–bridge, contradicting that  $t = 4$ .

So assume  $n = 1$ . Then  $\partial A_{23}$  is primitive in  $H_B$ . So  $H'_B = H_B \cup N(A_{23})$  is a genus two handlebody, as is its exterior  $H'_W = H_W - N(A_{23})$ . Then  $K \cap H'_W = (34123)$  is properly isotopic to the bridge arc (41) of  $H'_W$ , hence is bridge in  $H'_W$ .  $K \cap H'_B = \mu$  is properly isotopic to a cocore of  $B$  whose core is primitive in  $H_B$ . Thus  $\mu$  is a bridge arc in  $H'_B$ . That is,  $K$  is 1–bridge in the Heegaard splitting  $H'_B \cup H'_W$ , contradicting that  $t = 4$ . □

This completes the proof of Lemma 14.5. □

**Lemma 14.9** *Assume SITUATION NO SCC and that there is a FESC centered, WLOG, about a (23)–SC. There are bridge disks  $D_{12}$  and  $D_{34}$  disjoint from the edges of the (23)–SC. These bridge disks guide isotopies of the arcs (12),(34), fixing endpoints, onto arcs of  $\hat{F}$  that are incident to the same side in  $\hat{F}$  of the curve formed by the edges of this SC. Let  $A_{23}$  be the Möbius band associated to this SC. If  $\partial A_{23}$  is primitive in  $H_B$ , then  $K$  is 1–bridge with respect to a genus two Heegaard splitting of  $M$ .*

**Proof** WLOG we may assume there is a FESC  $\tau$  as shown in Figure 41(a). Its edges induce the subgraph of  $G_F$  shown in Figure 41(b).

Let  $E$  be a disk giving the parallelism guaranteed by Lemma 14.5. Let  $\rho_{12}$  and  $\rho_{34}$  be rectangles on  $\partial N((12))$  and  $\partial N((34))$  respectively that are between  $f$  and  $g$

and meet  $E$ . Then together  $f \cup g \cup E \cup \rho_{12} \cup \rho_{34}$  form a bridge disk  $D_{34}$  for (34) as shown in Figure 44(a). With a slight isotopy so that  $D_{34}$  is now disjoint from  $f \cup g \cup N((12))$  except along the  $x$  corner of  $g$ , it meets  $\widehat{F}$  as shown in Figure 44(b).

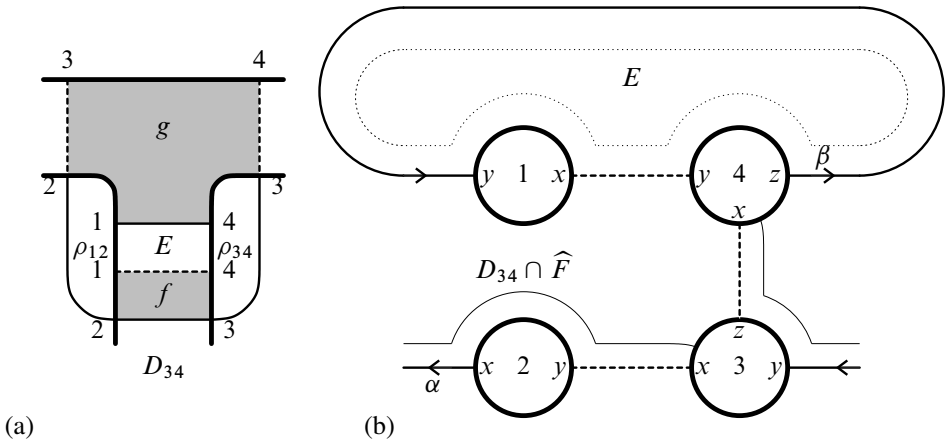

Figure 44

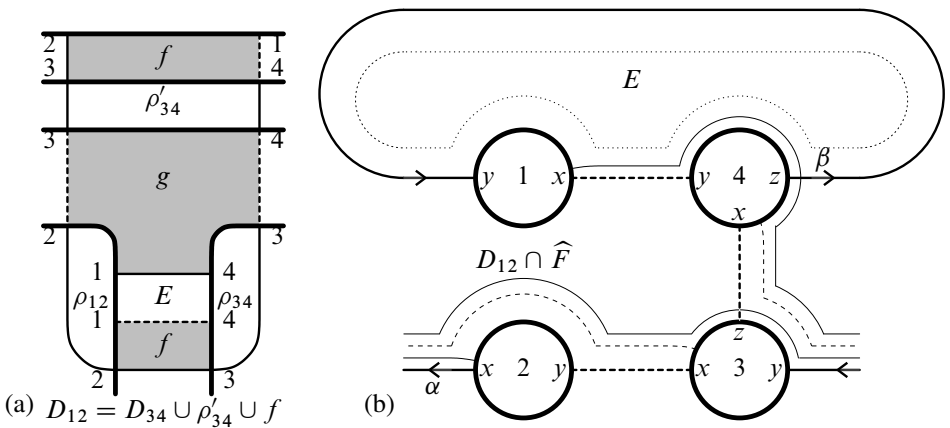

Figure 45

Let  $\rho_{34}'$  be a rectangle on  $\partial N((34))$  between the  $x$  corner of  $g$  and  $y$  corner of  $f$  and containing the  $z$  corner of  $g$ . Banding  $D_{34}$  to (12) with the rectangle  $\rho'_{34} \cup f$  produces the bridge disk  $D_{12} = D_{34} \cup \rho'_{34} \cup f$  shown in Figure 45(a) which may be made embedded and disjoint from  $D_{34}$  by a slight perturbation. Figure 45(b) shows how  $D_{12}$  and  $D_{34}$  meet  $\widehat{F}$ . In particular, they are incident to the same side of  $\partial A_{23}$ .

Now assume  $\partial A_{23}$  is primitive in  $H_B$ . So  $H'_B = H_B \cup N(A_{23})$  is a genus 2 handlebody, as is its exterior  $H'_W = H_W - N(A_{23})$ . Now argue as in the last paragraph of Claim 14.8. That is,  $K \cap H'_W = (34123)$  is properly isotopic to the bridge arc (41) of  $H'_W$ , hence is bridge in  $H'_W$ .  $K \cap H'_B = \mu$  is properly isotopic to a cocore of the annulus  $B$ , a neighborhood in  $\widehat{F}$  of  $\partial A_{23}$ . As  $\partial A_{23}$  is primitive in  $H_B$ ,  $\mu$  is a bridge arc in  $H'_B$ . That is,  $K$  is 1-bridge in the Heegaard splitting  $H'_B \cup H'_W$ , contradicting that  $t = 4$ .  $\square$

## 15 FESCs

Throughout this section assume  $t = 4$ , there are no Dyck's surfaces embedded in  $M$ , and we are in SITUATION NO SCC.

Convention: In this section, we will be discussing an interval of labels where the same label appears more than once. To distinguish the edges incident to that interval with the same label, we will subdivide the interval into subintervals each containing at most four labels. For example in Figure 48, the interval of labels at vertex  $x$  has two edges incident at label 1. This interval is divided into subintervals,  $x, x'$ . On  $G_F$  then, the edge incident to the subinterval  $x'$  will be labeled with an  $x'$  rather than  $x$ , as in Figure 50.

### 15.1 Type I and II FESCs

**Definition 15.1** By Lemma 14.5 two of the edges bounding a FESC are parallel on  $G_F$ . A FESC along a vertex  $x$  of  $G_Q$  is *type I* or *type II* (at  $x$ ) according to whether both or just one of these parallel edges are incident to the vertex. See Figure 46 for an illustration of types I and II at the vertex  $x$ .

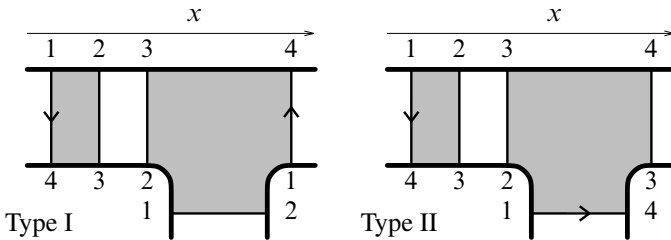

Figure 46

The boldface notation in the lemmas of this section refers to that of Section 13.

**Lemma 15.2**  $MST_{II} \implies MSTG$

At a vertex  $x$ , the trigon of a type II FESC cannot be further adjacent to another bigon or a trigon. In particular, a type II FESC must have its trigon adjacent to a true gap at  $x$ .

**Proof** Assume there is a type II FESC adjacent to another bigon or trigon. In the case of a bigon we construct a long disk<sup>3</sup> as in Figure 47. In the case of a trigon we construct a lopsided bigon<sup>4</sup> as in Figure 48. Hence in both cases there is a thinning of  $K$ .

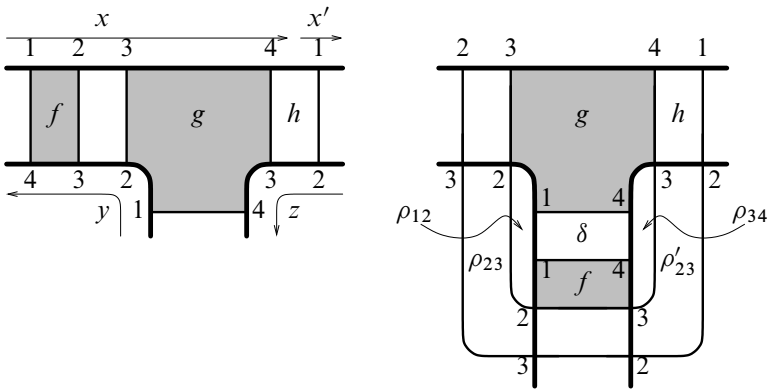

Figure 47

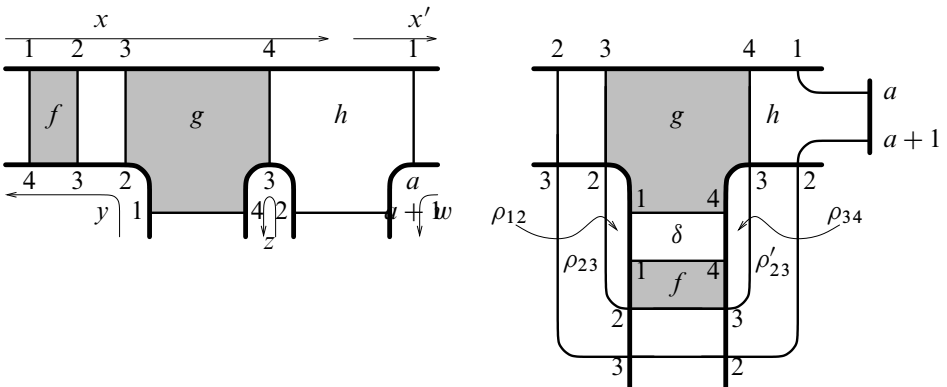

Figure 48

<sup>3</sup>See also [1, Lemma 2.2].

<sup>4</sup>See also the last two paragraphs of the of [1, Lemma 6.15].

In these figures  $\delta$  is the disk of parallelism guaranteed by Lemma 14.5, and  $\rho_{ab}$  denotes a rectangle on the boundary of the  $(ab)$  handle. Note that  $\rho_{23}$  and  $\rho'_{23}$  have disjoint interiors.

The long disk may be taken to lie on the boundary of the neighborhood of the 2–complex formed from the four faces and  $K$  as they are embed in  $M$ . The lopsided bigon will be embedded except at its short  $(a a + 1)$ –corner; nevertheless, the lopsided bigon guides an isotopy of  $K$ . Both the long disk and the lopsided bigon run over both sides of the (23)–SC.

To verify these isotopies explicitly, one may construct models of these 2–complexes, their neighborhoods and their intersections with  $\hat{F}$ . As the case when the adjoining face,  $h$ , is a trigon can be viewed as a “splintering” of the case when  $h$  is a bigon, we begin with the model of the bigon case.

**The long disk** Form a Möbius band out of the (23)–SC and the (23)–arc of  $K$ . Complete  $K$  and take a small regular neighborhood. The attachment of  $f$  is unique. The attachment of  $g$  is unique up to a choice of placement of its (34)–corner opposite the  $\overline{23}$ –edge. These two choices give mirror images and are thus equivalent up to homeomorphism. The boundary of  $\delta$  is now set and we may attach it. The bigon  $h$  may now also be attached along the  $\overline{34}$ –edge of  $g$  in a unique manner. Beginning from the corners of  $\delta$ , the choices for  $\rho_{12}$ ,  $\rho_{23}$ ,  $\rho_{34}$  and  $\rho'_{23}$  are determined. One may now “wrap” the long disk around this complex to exhibit an isotopy of (2341) onto  $\hat{F}$ . The graph on  $\hat{F}$  induced by the edges of these faces and the arc onto which the isotopy lays down (2341) is shown in Figure 49. Since  $K$  is isotopic to the arc (12) and an arc on  $\hat{F}$ , it is at most 1–bridge.

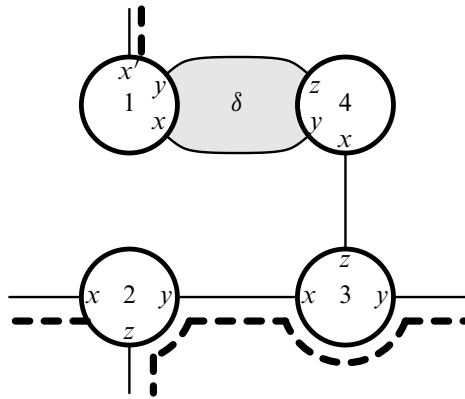

Figure 49

**Remark 15.3** The long disk can also be pictured as the union of the bridge disk  $D_{34}$  of Lemma 14.9 and a White bigon on corners  $(23),(41)$  gotten by banding  $h$  and two disjoint copies of the  $(23)$ -SC along the boundary of a neighborhood of the  $(23)$ -arc of  $K$ . This white bigon and  $D_{34}$  agree on  $F$  along one edge of the bigon.

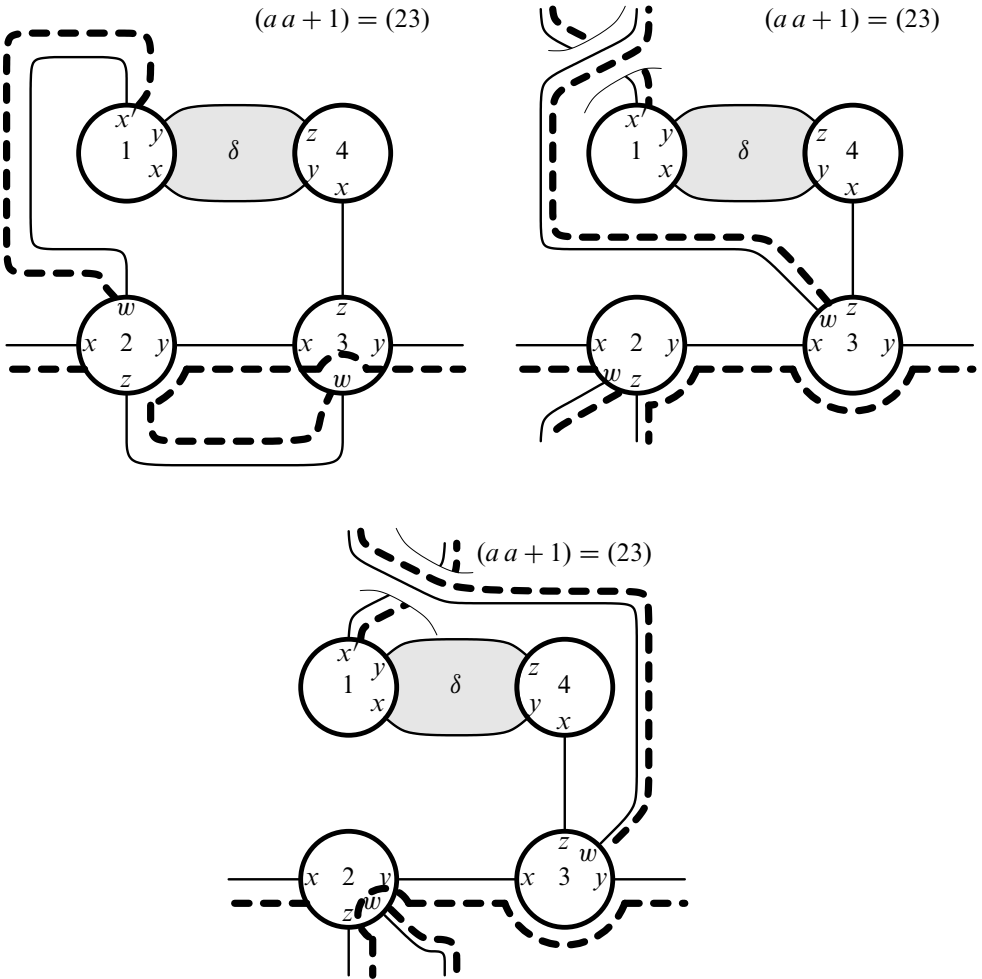

Figure 50

**The lopsided bigon** Take the above constructed complex and break the  $\overline{12}$ -edge of  $h$  by inserting a corner, thereby changing  $h$  from a bigon into a trigon. This new corner will be either a  $(23)$ - or a  $(41)$ -corner. To complete this model, this corner must be attached to  $K$ . The long disk isotopy now becomes an isotopy of  $(2341)$  onto two

arcs of  $\widehat{F}$  and either the (23)– or (41)–arc of  $K$ . There are seven possible ways of hooking up this new corner to its position on the complex: three for (23) and four for (41). When the new corner is a (23)–corner, Figure 50 shows the three possible graphs on  $\widehat{F}$  and the resulting two arcs on  $\widehat{F}$  after the isotopy of (2341). Figure 51 shows four possibilities when the new corner is a (41)–corner. Note that  $\overline{41}$ –edge of  $h$  cannot lie in  $\delta$  by Lemma 8.15. Since  $K$  is isotopic to the union of arc (12), two arcs on  $\widehat{F}$  and one of the arcs (23) or (41), it is at most 1–bridge.  $\square$

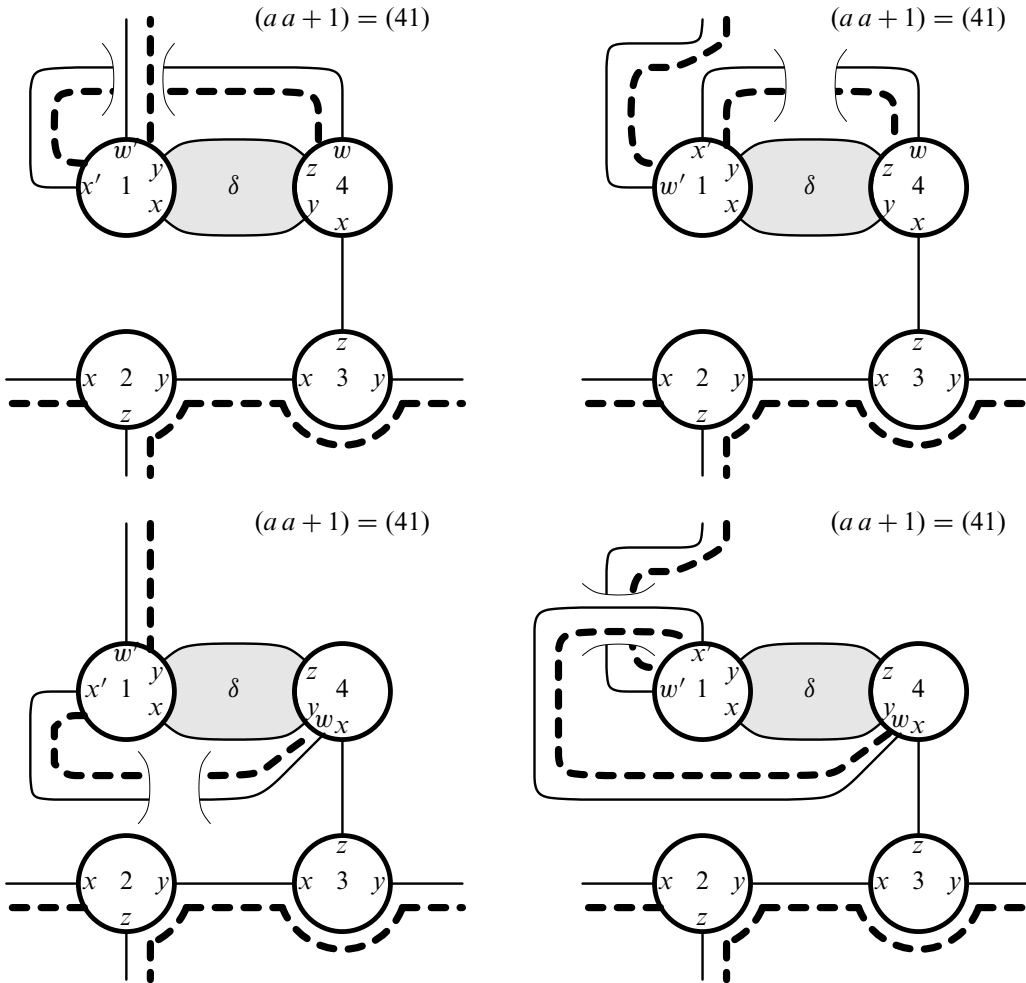

Figure 51

**Remark 15.4** As in the remark above for the long disk, the lopsided bigon can be pictured as the union of the Black bridge disk  $D_{34}$  with a new White trigon gotten



by banding  $h$  and two copies of the (23)–SC. The new trigon has the property that it matches the bridge disk along one of its edges (and disjoint elsewhere).

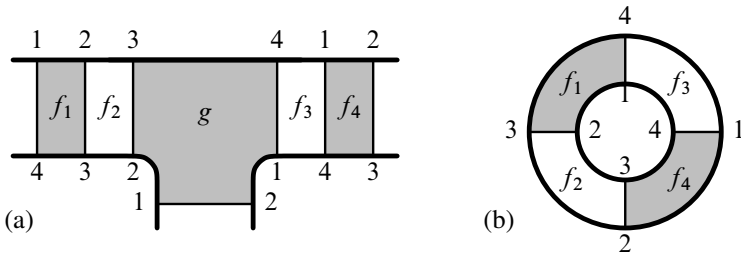

Figure 52

**Lemma 15.5**  $BBTBB \implies SMTMS$ . In particular, the T is a Scharlemann cycle.

**Proof** If the T were a Scharlemann cycle, then the desired conclusion would follow, so assume otherwise. By Lemma 15.2, if one of the B adjacent to the T is an S, then the other is too. Hence we assume we have MSTSM as shown, WLOG, in Figure 52(a).

By Lemma 14.5, the  $\overline{41}$ –edges of  $f_1$  and  $g$  are parallel as are the  $\overline{23}$ –edges of  $f_4$  and  $g$ . Using these parallelisms we may form the annulus  $f_1 \cup f_2 \cup f_3 \cup f_4$  shown in Figure 52(b). Since the two boundary components of this annulus each run along  $K$  once in opposite directions, joining them along  $K$  forms an embedded Klein bottle. This is a contradiction.  $\square$

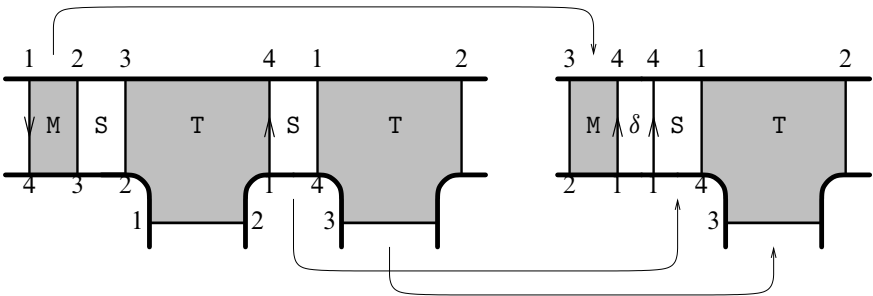

Figure 53

**Lemma 15.6**  $MSTB \implies MSTSG$  or  $MSTSTG$ .

**Proof** Given MSTB at a vertex,  $B = S$  since otherwise MST would form a type II FESC, giving a contradiction to [Lemma 15.2](#). We cannot have MSTSB since this contradicts [Lemma 15.5](#). Thus we have either MSTSG or MSTST. We continue to examine the latter.

Since the initial MST forms a type I FESC, we have a parallelism  $\delta$  on  $G_F$  between the leftmost edge of the M and the rightmost edge of the T. We may use this to attach the M to the S of the subsequent ST to form a FESC. This is illustrated in [Figure 53](#) (without loss of generality we may use the labeling shown). By the proof of [Lemma 14.5](#) (see the remark there) there is a parallelism  $\delta'$  of the  $\overline{23}$ -edge of the M to a  $\overline{23}$ -edge of the T. [Lemma 8.15](#) forces this  $\overline{23}$ -edge of T to not be incident to the vertex and thus the unlabeled corner in [Figure 53](#) is a (12)-corner. Following the proof of [Lemma 15.2](#) we may build either a long disk or lopsided bigon as shown in [Figure 54](#).

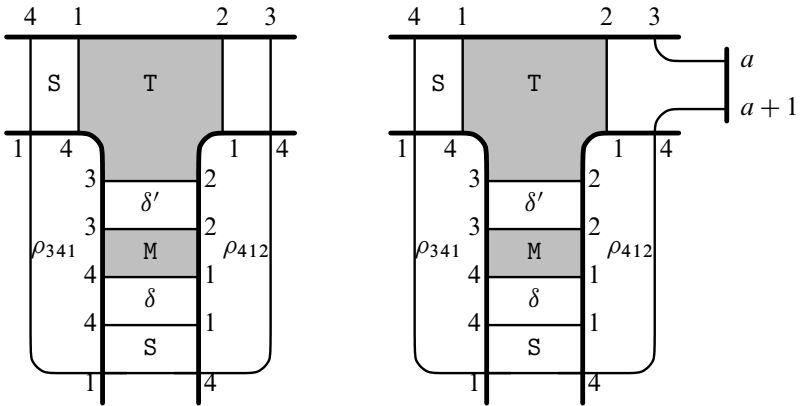

Figure 54

(Note that the regions  $\rho_{341}$  and  $\rho_{412}$  in  $\partial N(K)$  must be as in [Figure 55\(a\)](#) and not (b). The corner  $x$  is labeled in each; in (b) two continue into  $\delta'$  contrary to [Lemma 8.15](#).) Therefore there cannot be a bigon or trigon incident to the  $\overline{12}$ -edge of this T.

Hence if we have MSTST, we then have MSTSTG. □

**Remark 15.7** From the point of view of the remarks in the proof of [Lemma 15.2](#), the White bigon or trigon constructed is the same as there, the difference is in the construction of the Black bridge disk where the parallelism (here given by  $\delta$ ) is used to modify the bridge disk on the Black side to line up with the White bigon, trigon along an edge.

**Lemma 15.8** MSTTSM cannot occur.



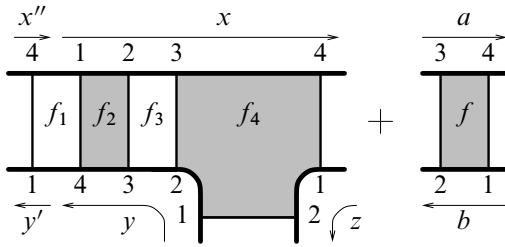

Figure 56

Let  $A_{23}, A_{41}$  be the Möbius bands in  $H_W$  gotten from the bigon Scharlemann cycles of the SMST configuration. By Lemma 14.9,  $\partial A_{23}$  cannot be primitive in  $H_B$ . A similar argument shows that  $\partial A_{41}$  cannot be primitive: Otherwise consider the new genus two Heegaard splitting gotten by attaching  $N(A_{41})$  to  $H_B$ . Then constructing the right bridge disks  $\Delta_{12}$  and  $\Delta_{34}$  as in Lemma 14.9 (see the left or right of Figure 57, ignoring the  $\overline{23}$ -edge with  $a, b$  endpoints and setting  $a = x'', b = y'$  on vertices 4 and 1), one sees that the (12)-arc and (34)-arc of  $K$  can be isotoped (rel endpoints) to arcs on  $\hat{F}$  that are incident to  $\partial A_{41}$  on the same side (and otherwise disjoint from it). We then get a 1-bridge presentation of  $K$  with respect to the new splitting by isotoping it to a (12341)-arc and an arc which is a cocore of  $N(\partial A_{41})$ ; a contradiction.

We assume for contradiction that neither edge of  $f$  is parallel on  $G_F$  to an edge of  $f_2, f_3, f_4$ . Applying Lemma 14.5 to the FESC, the edges of  $f$  and of the FESC must appear on  $G_F$  as in one of the two configurations of Figure 57.

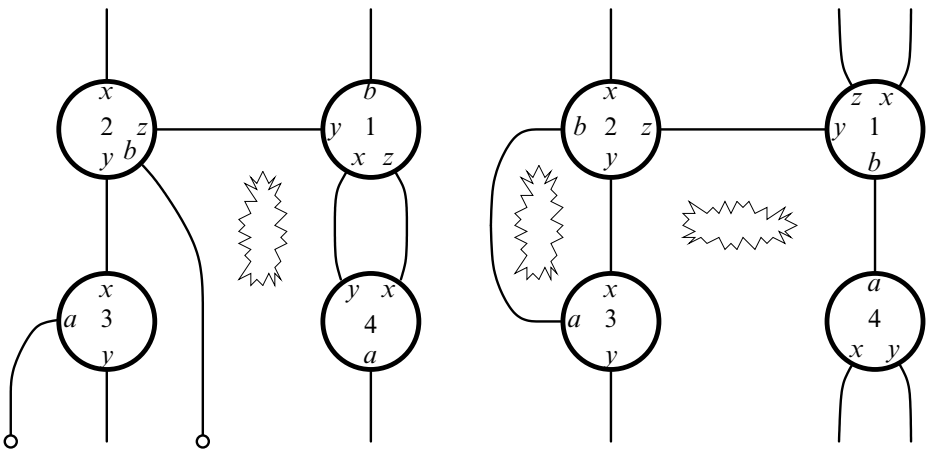

Figure 57

Let  $A_{12,34}$  be the annulus gotten from the union of  $f_2$  and  $f$ . Since no two of the edges of these faces are parallel on  $G_F$ , each component of  $\partial A_{12,34}$  is essential in  $\hat{F}$ . Furthermore,  $A_{12,34}$  must be incompressible in  $H_B$ , otherwise we get a Black disk that either makes  $\partial A_{23}$  primitive in  $H_B$  or compresses  $\hat{F}$  to induce the formation of a Klein bottle in  $M$  from  $A_{23}, A_{41}$ .

As in the proof of Lemma 14.9, we construct a thinning disk  $\Delta_{12}$  from  $f_2, f_4$ .  $\partial$ -compressing  $A_{12,34}$  along  $\Delta_{12}$ , we get a Black disk,  $D$ , with the boundary as in Figure 58. In Case (A) of that figure,  $\partial D$  intersects  $\partial A_{23}$  once, implying that  $\partial A_{23}$  is primitive.

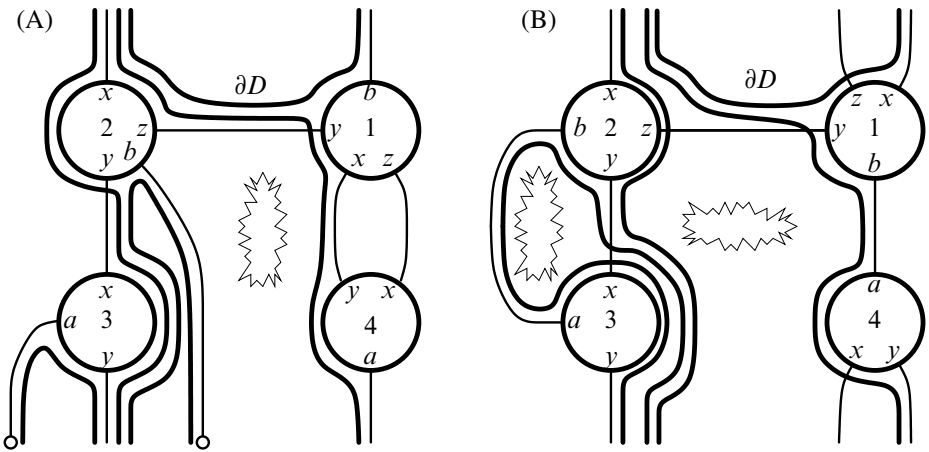

Figure 58

Thus we assume we are in Case (B), where  $\partial D$  intersects  $\partial A_{23}$  algebraically zero times and geometrically twice. If  $D$  is nonseparating, then we can construct a Dyck's surface in  $M$  by attaching to  $A_{23}$  the once-punctured torus or Klein bottle in  $H_B$  pictured in Figure 59.

Thus we may assume  $D$  is separating in  $H_B$ . As  $D$  is homologous to  $A_{12,34}$ , this annulus must be separating in  $H_B$ . Let  $B$  be the annulus bounded by  $\partial A_{12,34}$  on  $\hat{F}$ . Note that  $\partial D$  is not trivial in  $\hat{F}$ , for if so an edge of  $f$  would be parallel on  $G_F$  to one of the edges of  $f_2$  or  $f_3$  contrary to assumption. Thus  $A_{12,34}$  is an incompressible, separating annulus in  $H_B$ . Note that if  $A_{12,34}$  is parallel to  $\partial H_B$ , then each component of  $\partial A_{12,34}$  is primitive in  $H_B$ . Let  $P$  be the 4-punctured sphere that is the union in  $\hat{F}$  of the edges of  $f, f_2, f_3, f_4$ , the fat vertices of  $G_F$ , and the disk of parallelism on  $G_F$  between the  $\overline{41}$ -edges of  $f_2$  and  $f_4$ . Then the closure of  $\hat{F} - P$  is two annuli, one of which is  $B$ . Call the other  $B'$ . See Figure 60.

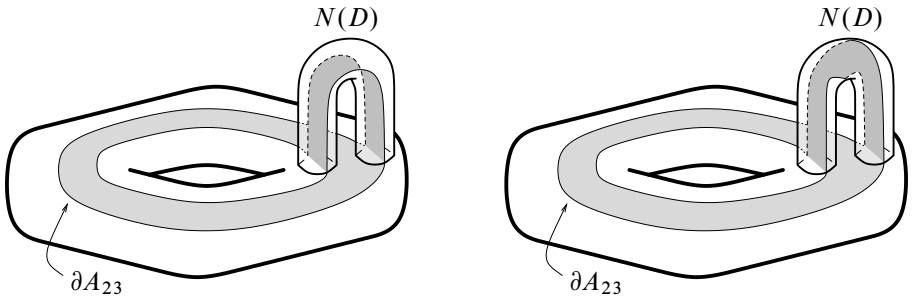

Figure 59

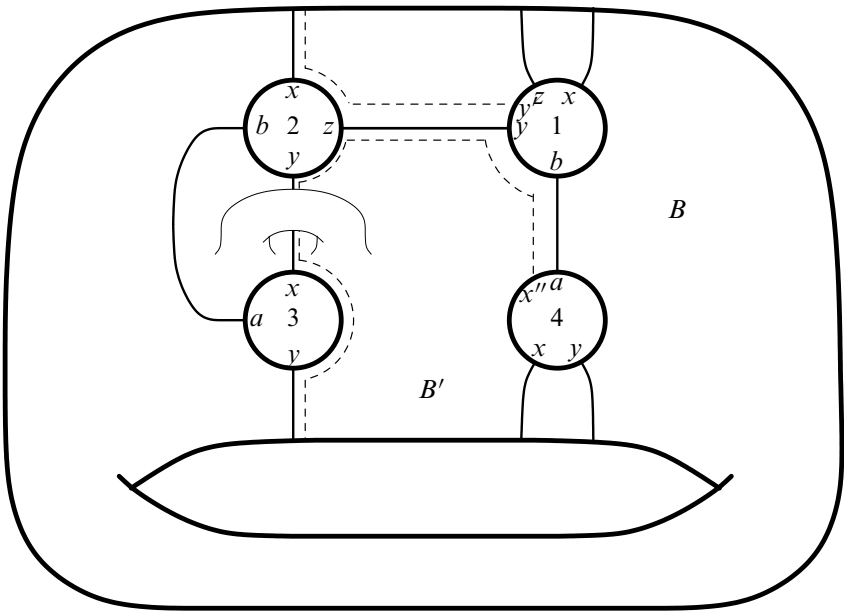

Figure 60

**Claim 15.11** Let  $e$  be the  $\overline{41}$ -edge that  $f_1$  does not share with  $f_2$ . Then  $e$  on  $G_F$  is either (i) the dotted line in Figure 60, or (ii) parallel to the  $\overline{41}$ -edge of  $f$ .

**Proof** If  $e$  lies in  $B$  on  $G_F$  then it is isotopic into  $\partial B$  and hence is parallel to either the  $\overline{41}$ -edge of  $f_2$  or  $f$ . The former cannot occur else  $M$  has a lens space summand, the latter is conclusion (ii). If  $e$  lies in  $B'$  then it is isotopic into  $\partial B'$  and hence either is parallel to the  $\overline{41}$ -edge of  $f$  yielding conclusion (ii), is parallel to the  $\overline{41}$ -edge of  $f_2$  (a contradiction as above), is parallel to the dotted edge in Figure 60 yielding

conclusion (i), or is such that  $\partial A_{41}$  would be isotopic on  $\hat{F}$  to  $\partial A_{23}$  giving a Klein bottle in  $M$ .  $\square$

Assume  $e$  is as in (i) of the Claim. Then  $A_{41}, A_{12,34}$  and  $D$  can be perturbed to be disjoint with boundaries as indicated in Figure 61 (by forming these with the given faces and the appropriate rectangles along  $\partial N(K)$ ).  $D$  divides  $H_B$  into two solid tori  $\mathcal{T} \cup \mathcal{T}'$ , where  $\partial \mathcal{T}$  contains  $\partial A_{41}$ . Since  $\partial A_{41}$  is not primitive in  $H_B$ , it is not longitudinal in  $\mathcal{T}$ . Let  $\mathcal{N} = \mathcal{T} \cup N(A_{41})$ . Then  $\mathcal{N}$  is a Seifert fiber space over the disk with two exceptional fibers. A close look at Figure 61 shows that we can perturb  $K$  so that  $K \cap \mathcal{N}$  is a single arc,  $\eta$ , (basically the (41)–arc) which is isotopic to the cocore of the Möbius band  $A_{41}$ . Lemma 8.3 now produces a genus 2 Heegaard splitting of  $M$  in which  $K$  is 0–bridge, a contradiction.

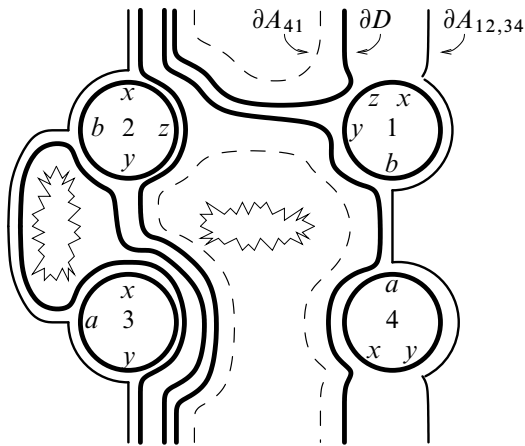

Figure 61

So assume  $e$  is as in conclusion (ii) of the Claim. As  $\partial A_{41}$  is isotopic to a component of  $\partial A_{12,34}$ , and  $\partial A_{41}$  is not primitive in  $H_B$ ,  $A_{12,34}$  is not parallel into  $\hat{F}$ . We can enlarge the annulus  $B$  slightly in  $\hat{F}$  so that it contains  $\partial A_{41}$ . Let  $\mathcal{T}$  be the solid torus bounded by  $B \cup A_{12,34}$  in  $H_B$ . Then  $\mathcal{N} = N(\mathcal{T} \cup A_{41})$  is a Seifert fiber space over the disk with two exceptional fibers.  $K \cap \mathcal{N}$  is a single arc which is a cocore of a properly embedded Möbius band,  $A_{12,34} \cup A_{41}$ , in  $\mathcal{N}$ . Lemma 8.3 now applies to produce a genus 2 Heegaard splitting of  $M$  in which  $K$  is 0–bridge, a contradiction.

This last contradiction proves the first conclusion of the Lemma, that some edge of  $f$  must be parallel in  $G_F$  to an edge of  $f_2, f_3, f_4$ . Furthermore, if one edge of  $f$  is parallel to an edge of  $f_2$ , then, in fact,  $f$  is parallel to  $f_2$ . For otherwise, banding  $f$  and  $f_2$  together along these parallel edges, and perturbing slightly gives a disk in  $H_B$

whose nontrivial boundary intersects  $\partial A_{23} \cup \partial A_{41}$  at most once. If this disk is disjoint from  $\partial A_{23} \cup \partial A_{41}$ , and the boundary of the disk is nonseparating in  $\widehat{F}$ , then  $\partial A_{23}$  and  $\partial A_{41}$  will be isotopic in  $\widehat{F}$  surgered along this disk, and  $M$  contains a Klein bottle. If disjoint and the boundary of the disk is separating, then one of  $\partial A_{23}, \partial A_{41}$  must be primitive in  $H_B$  since  $M$  is irreducible, atoroidal, and the Heegaard splitting is strongly irreducible (Lemma 3.3). If the disk intersects  $\partial A_{23} \cup \partial A_{41}$  once, then one of these Möbius bands will have primitive boundary in  $H_B$ .

Finally, assume  $f$  is incident to vertex  $x$ . Then Lemma 8.15 says that  $f$  cannot be parallel to  $f_2$  (both  $\overline{41}$ -edges of the FESC are parallel on  $G_F$ ). Thus the  $\overline{23}$ -edge of  $f$  must be parallel in  $G_F$  with the  $\overline{23}$ -edge of  $f_3$  that is not shared with  $f_2$ . Applying this argument to another mixed black bigon incident to vertex  $x$ , will then contradict Lemma 8.15. □

**Lemma 15.12** *Assume there is an MST configuration incident to vertex  $x$ . WLOG assume the bigon Scharlemann cycles of this configuration are on the White side. Then any Black mixed bigon,  $f$ , must have an edge which is parallel on  $G_F$  to an edge in the MST subconfiguration (the FESC). Furthermore, if that edge is parallel to an edge of the M in the MST, then  $f$  is parallel to  $M$ . In particular, there is at most one more Black mixed bigon incident to  $x$ .*

**Proof** This is the same as the proof for Lemma 15.10. Note that the FESC is of type I at  $x$  and in both contexts one edge of the additional White SC has an edge parallel to both the M and T in the FESC, MST. □

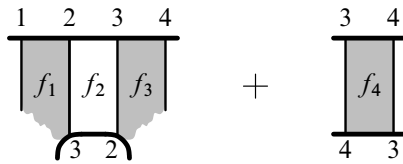

Figure 62

**Lemma 15.13** *Assume  $\Lambda$  contains a FESC and an SC on the side of  $\widehat{F}$  opposite to that of the SC in the FESC, then the corresponding Möbius bands can be perturbed to be disjoint.*

That is, WLOG assume we have the configurations of Figure 62, where one of  $f_1, f_3$  is a bigon and the other is a trigon and where  $f_4$  is a Black SC ( $f_4$  could equally well be a (12)-SC). Let  $A_{23}, A_{34}$  be the Möbius bands corresponding to  $f_2, f_4$ . If  $\partial A_{23}$  and  $\partial A_{34}$  intersect transversely once, then  $K$  is 1-bridge with respect to a genus two Heegaard splitting of  $M$ .



**Proof** Without loss of generality assume  $f_1$  is a bigon and  $f_3$  is a trigon. In this proof we consider faces of  $G_Q$  as disks properly embedded in  $H_B - N(K), H_W - N(K)$ . The proof of Lemma 14.9 shows that there are thinning disks  $\Delta_{34}, \Delta_{12}$  for (34), (12) disjoint from  $f_2$ .

In fact, the thinning disk  $\Delta_{34}$  may be chosen to be disjoint from  $f_4$  as well as  $f_2$ : Isotop  $\partial\Delta_{34} \cap N((34))$  so that it is disjoint from  $f_2$  and  $f_4$ , for example as in Figure 63.

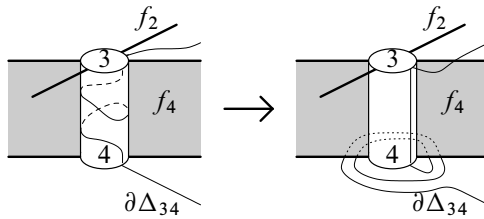

Figure 63

After surgering  $\Delta_{34}$ , we may assume it intersects  $f_4$  in transverse arcs (ie from one edge of  $f_4$  to the other). Band an outermost disk of intersection along  $f_4$  to give a thinning disk disjoint from both  $f_2$  and  $f_4$ .

Using  $\Delta_{34}$  to  $\partial$ -compress  $A_{34}$  yields a Black disk intersecting  $\partial A_{23}$  transversely once. See, for example, Figure 64. Thus  $\partial A_{23}$  is primitive in  $H_B$ . Apply Lemma 14.9.  $\square$

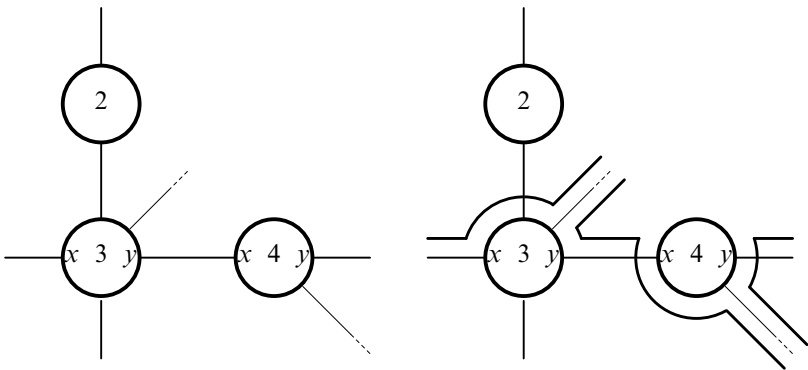

Figure 64

**Lemma 15.14** Assume  $G_Q$  has a configuration SMST where WLOG the SCs are on the White side. Then  $G_Q$  contains no Black SC.

The same conclusion holds for the configuration MSTs.

**Proof** WLOG we assume the SMST configuration on  $G_Q$  is as in Figure 56 (without the face  $f$ ). Assume for contradiction that  $G_Q$  also contains a Black SC,  $h$ . Denote by  $A_{23}, A_{41}, A_h$ , the Möbius bands that result from  $f_1, f_3, h$  (respectively). As argued in Lemma 15.10, neither  $\partial A_{23}$  nor  $\partial A_{41}$  can be primitive in  $H_B$ . By Lemma 15.13,  $\partial A_h$  can be perturbed to be disjoint from  $\partial A_{23}$ . Since  $M$  contains no Dyck’s surface,  $\partial A_{41}$  must intersect  $\partial A_h$  transversely once (at either vertex 1 or 4). Now follow the argument of Lemma 15.13. Let  $\Delta_{12}, \Delta_{34}$  be the bridge disks constructed as in Lemma 14.9. These bridge disks can be taken disjoint from both  $f_1$  and  $h$ . Then boundary compressing  $A_h$  along one of these disks gives a disk in  $H_B$  intersecting  $\partial A_{41}$  once. But this implies  $\partial A_{41}$  is primitive in  $H_B$ .

Applying Lemma 14.5, the same argument shows that configuration MSTs where the S are White implies there are no Black S. □

## 16 Bigons and trigons when $t = 4$

Throughout this section assume  $t = 4$ , there are no Dyck’s surfaces embedded in  $M$ , and we are in SITUATION NO SCC. Recall that an  $(ab)$ -SC is a bigon Scharlemann cycle on the labels  $a, b$ .

### 16.1 Embeddings of SCs and mixed trigons in a handlebody

**Lemma 16.1** *Given three  $(12)$ -SCs, one  $(34)$ -SC, and three more  $\overline{34}$ -edges, then either three of the six  $\overline{12}$ -edges are parallel in  $G_F$  or three of the five  $\overline{34}$ -edges are parallel in  $G_F$ . Furthermore, if the three extra  $\overline{34}$ -edges form a trigon Scharlemann cycle then three  $\overline{12}$ -edges are parallel.*

**Proof** Assume these SCs are contained in the handlebody  $H$ .

If there exists a compressing disk  $D$  in  $H$  that separates the  $(12)$ -SCs from the  $(34)$ -SC, then in one of the solid tori of  $H \setminus D$  the three  $(12)$ -SCs are all parallel. Hence three of their  $\overline{12}$ -edges are parallel in  $G_F$ .

If there exists a compressing disk  $D$  in  $H$  disjoint from these Scharlemann cycles that is nonseparating, then  $H \setminus D$  is a solid torus containing a  $(12)$ -SC and a  $(34)$ -SC. Thus there are two disjoint Möbius bands in this solid torus, a contradiction.

If no compressing disk of  $H$  is disjoint from the  $(12)$ -SCs and the  $(34)$ -SC, then any pair of  $(12)$ -SCs are either parallel or have no parallel edges (else band two SCs together along parallel edges). In particular, only two are parallel. (If all three  $(12)$ -SCs were parallel there would be a disk separating them from the  $(34)$ -SC.) The

complement in  $H$  of these (12)–SCs and the (12)–arc of  $K$  is then one or two solid tori, that meet  $\widehat{F}$  in annuli, and a ball (the parallelism). Since the subgraph of  $G_F$  consisting of vertices 3 and 4 and the five  $\overline{34}$ –edges must lie in one of the annuli, three  $\overline{34}$ –edges must be parallel.

If the three extra  $\overline{34}$ –edges form a Scharlemann cycle trigon, then we must be in the former case of three parallel  $\overline{12}$ –edges, as the edges of a (34)–SC and a (34)–Scharlemann cycle trigon cannot lie together in an annulus (eg [14, Lemma 2.1]).  $\square$

**Lemma 16.2** *Given two (12)–SCs and two (34)–SCs then either one pair is parallel or each pair has a pair of parallel edges.*

**Proof** Assume no pair of edges of the (12)–SCs are parallel. Then the complement of the graph of these four edges and the vertices 1 and 2 in the boundary of the handlebody must be a collection of annuli. Hence the edges of the (34)–SCs lie in an annulus. Since handlebodies are irreducible and the edges of these Scharlemann cycles cannot lie in a disk, the (34)–SCs are parallel.

Similarly, if no pair of edges of the (34)–SCs are parallel, then the (12)–SCs are parallel.  $\square$

**Lemma 16.3** *Given a (12)–SC, a (34)–SC and a trigon of  $\Lambda$  with two (12)–corners and one (34)–corner, then there are two embeddings in their genus 2 handlebody  $H$  up to homeomorphism. One has a pair of parallel  $\overline{12}$ –edges; the other does not. These are shown in Figure 65 with  $H$  cut along the two SCs.*

**Proof** Let  $A_{12}$  and  $A_{34}$  be the Möbius bands associated to the two SCs in the handlebody  $H$ . Then  $H \setminus (A_{12} \cup A_{34})$  is a genus 2 handlebody  $H'$ . The impressions  $\tilde{A}_{12}$  and  $\tilde{A}_{34}$  of the Möbius bands are primitive annuli in  $H'$  and each has a primitivizing disk disjoint from the other annulus. Attach a 2–handle to  $H'$  along the core of  $\tilde{A}_{12}$  to form a solid torus  $\mathcal{T}$ . The primitivizing disk for  $\tilde{A}_{12}$  extends to a disk  $\delta$  giving a boundary-parallelism for the cocore  $c$  of this 2–handle. Moreover  $\delta$  is disjoint from the (now longitudinal) annulus  $\tilde{A}_{34}$ .

Let  $g$  be the trigon. The two (12)–corners of  $g$  are identified along  $c$  to form  $\tilde{g}$  in  $\mathcal{T}$ . If  $A_{12}$  and  $g$  meet transversely along (12) in  $H$ , then  $\tilde{g}$  is an annulus. Otherwise  $\tilde{g}$  is a Möbius band. In each situation,  $c$  is a spanning arc of  $\tilde{g}$ ,  $\tilde{g}$  is properly embedded, and  $\partial\tilde{g}$  crosses the longitudinal annulus  $\tilde{A}_{34}$  in  $\partial\mathcal{T}$  just once.

If  $\tilde{g}$  is a Möbius band, then its embedding in  $\mathcal{T}$  is unique up to homeomorphism. If  $\tilde{g}$  is an annulus, then one boundary component is disjoint from  $\tilde{A}_{34}$  and trivial on  $\partial\mathcal{T}$ ;

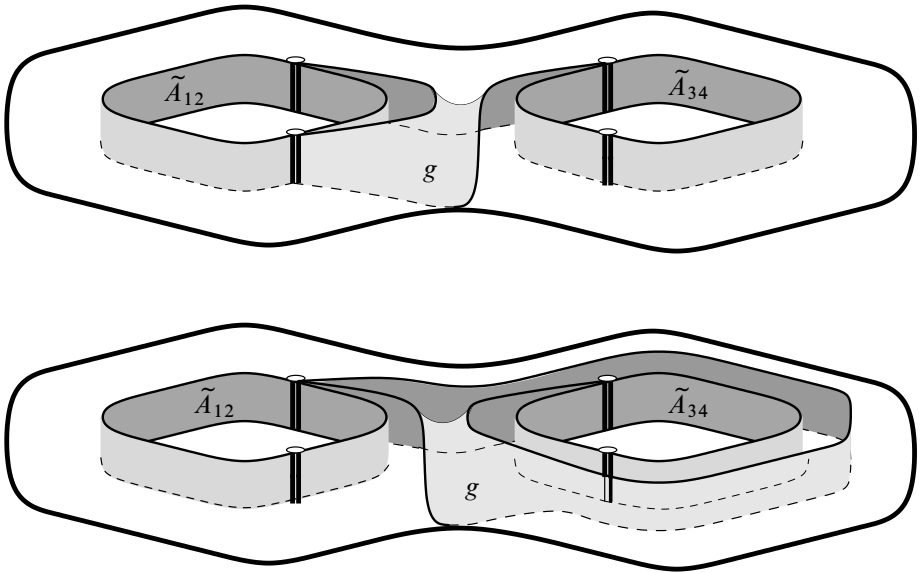

Figure 65

because the spanning arc  $c$  (on  $\tilde{g}$ ) is trivial in  $\mathcal{T}$ , the embedding of  $\tilde{g}$  in  $\mathcal{T}$  is unique up to homeomorphism. Recover  $H'$  with the impression  $\tilde{A}_{12}$  from  $\mathcal{T} \setminus c$ . Carrying the two possibilities of  $\tilde{g}$  along produces the two embeddings of  $g$  in  $H'$  shown in Figure 65. Reconstitute  $H$  and the two Möbius bands by sewing up  $\tilde{A}_{12}$  and  $\tilde{A}_{34}$ . This gives the two claimed embeddings of  $g$  in  $H$ .  $\square$

**Lemma 16.4** *Given a (12)–SC, a (34)–SC, a trigon of  $\Lambda$  with two (12)–corners and one (34)–corner, and a trigon of  $\Lambda$  with two (34)–corners and one (12)–corner, then either a pair of  $\overline{12}$ –edges or a pair of  $\overline{34}$ –edges must be parallel.*

**Proof** Otherwise by Lemma 16.3 each trigon lives in  $H' = H \setminus (A_{12} \cup A_{34})$  as pictured in the second part of Figure 65. These trigon faces form a meridian system for  $H'$ , where dual curves give generators  $x, y$  of  $H_1(H')$ . Up to swapping the generators and taking their inverses, the core of  $\tilde{A}_{12}$  represents  $xy^2$  in  $H_1(H')$ , and the core of  $\tilde{A}_{34}$  may be oriented to then represent either  $yx^2$  or  $yx^{-2}$ . In either case, attaching 2–handles to  $H'$  along the cores of  $\tilde{A}_{12}, \tilde{A}_{34}$  gives a manifold with nontrivial torsion in first homology. But from Figure 65, one sees that attaching such 2–handles gives a 3–ball.  $\square$

## 16.2 Configurations containing an ESC

Recall from Section 6.3 that an annulus is primitive if and only a component of its boundary is primitive in the ambient handlebody.

**Proposition 16.5** *If there is an ESC such that the extending annulus is nonseparating in its handlebody, then the boundary of the central Möbius band is primitive with respect to the extending annulus’s handlebody. Hence the extending annulus is primitive in its handlebody.*

**Proof** Assume there is an ESC on the corner (1234) giving rise to a central White Möbius band  $A_{23}$  and an extending Black annulus  $A_{12,34}$ . Assume  $A_{12,34}$  is nonseparating in  $H_B$  and that  $\partial A_{23}$  is not primitive with respect to  $H_B$ .

There exists a bridge disk  $D_{12}$  for (12) that is disjoint from  $A_{12,34}$ . Indeed,  $D_{12}$  is a  $\partial$ -compressing disk for the annulus  $A_{12,34}$ . Performing the  $\partial$ -compression on a push-off of this annulus produces a nonseparating disk  $D_B$  in  $H_B$  that is disjoint from  $A_{12,34}$  and  $K$ . Let  $\mathcal{T}$  be the solid torus obtained by compressing  $H_B$  along  $D_B$ . Then  $A_{12,34}$  is contained in  $\mathcal{T}$  and is  $\partial$ -parallel into  $\partial\mathcal{T}$ .

Either both curves of  $\partial A_{12,34}$  are primitive on  $H_B$  or both are nonprimitive. Since  $\partial A_{23}$  is a component of  $\partial A_{12,34}$ , the former case is contrary to assumption. Hence we may assume  $\partial A_{12,34}$  consists of two nonprimitive curves in  $H_B$ . Therefore in  $\mathcal{T}$  the  $\partial$ -parallel annulus  $A_{12,34}$  wraps  $n > 1$  times longitudinally. Then  $\mathcal{N} = \mathcal{T} \cup N(A_{23})$  is a Seifert fiber space over the disk with two exceptional fibers of orders 2 and  $n$ . Furthermore  $K \cap \mathcal{N}$  is the arc (1234) that is the cocore of the long Möbius band  $A_{23} \cup A_{12,34}$ . Lemma 8.3 now applies to produce a genus 2 Heegaard splitting of  $M$  in which  $K$  is 0-bridge, a contradiction.  $\square$

**Lemma 16.6** *If there is an ESC then the extending annulus is  $\partial$ -parallel in its handlebody but is not primitive.*

**Proof** Assume there is an ESC on the corner (1234). Let  $A_{12,34}$  be the corresponding extending Black annulus.

Assume  $\partial A_{23}$  is a primitive curve on  $\partial H_B$  with respect to  $H_B$ . It follows that  $H'_B = H_B \cup_{\partial A_{23}} N(A_{23})$  is a handlebody in which (1234) is bridge. Also  $H'_W = H_W \setminus A_{23}$  is a handlebody in which (41) remains bridge. Thus  $(H'_B, H'_W)$  is a Heegaard splitting of  $M$  in which  $K$  is 1-bridge. This contradicts the minimality assumption on  $t$ . Hence  $\partial A_{23}$  cannot be primitive in  $H_B$ .

Consequently, Proposition 16.5 also implies that  $A_{12,34}$  must be separating in  $H_B$ . Chopping  $H_B$  along  $A_{12,34}$  forms a genus 2 handlebody  $H'_B$  and a solid torus  $\mathcal{T}$ .

We may assume  $A_{12,34}$  is not longitudinal in  $\mathcal{T}$ . Lemma 8.3 applied to the Seifert fiber space over the disk given by  $N(A_{23}) \cup \mathcal{T}$  contradicts that  $t = 4$ .  $\square$

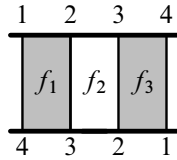

Figure 66

**Lemma 16.7** Assume  $\Lambda$  has an ESC. After relabeling so that the ESC is labeled as in Figure 66, then in  $\Lambda$  any White bigon is an SC and any White trigon is a (41)–Scharlemann cycle. Furthermore any such (23)–SC must have its edges parallel to those of  $f_2$ .

**Proof** Given the ESC on the corner (1234) as in Figure 66 let  $A_{23}$  be the corresponding White Möbius band and  $A_{12,34}$  be the extending Black annulus. By Lemma 16.6 the annulus  $A_{12,34}$  is parallel to an annulus  $B_{12,34}$  on  $\hat{F}$ .

The arguments of Lemma 12.4 prove that a White bigon must be a SC, while the arguments of Lemma 12.10 prove there is no White trigon with just one (23)–corner. Lemma 12.11 shows there cannot be a (23)–Scharlemann cycle of length 3. By an argument similar to that of Lemma 12.12, a trigon with two (23)–corners and one (41)–corner may be used in conjunction with the (23)–SC of the ESC to form a bridge disk for (41) with interior disjoint from  $B_{12,34}$ ; this provides a thinning of  $K$ . Hence a White trigon must be a (41)–Scharlemann cycle.

Let  $\sigma$  be a (23)–SC and  $f$  be the face it bounds. One of the edges of  $\sigma$  must lie in  $B_{12,34}$ , call it  $e_1$ , and the other,  $e_2$ , lies outside of  $B_{12,34}$ . Then  $e_1$  must be parallel to an edge  $e'_1$  of  $f_2$ . Let  $e'_2$  be the other edge of  $f_2$ .

We assume  $e_2, e'_2$  are not parallel on  $G_F$ . Then  $f, f_2$  can be amalgamated along the parallelism of  $e_1, e'_1$  to give a White meridional disk  $D$  disjoint from  $K$  and  $B_{12,34}$ . See Figure 67. But then  $K$  can be isotoped into the solid torus  $H_W - N(D)$  using the parallelism of  $A_{12,34}$  to  $B_{12,34}$ , a contradiction.  $\square$

**Lemma 16.8** There must be a true gap contiguous to an ESC of  $\Lambda$ .

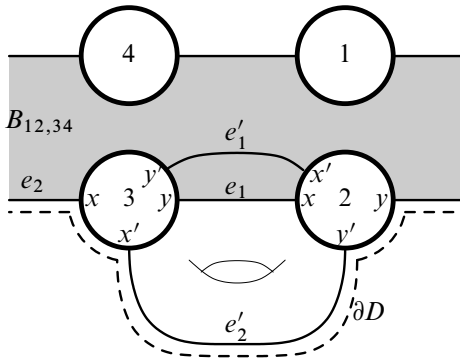

Figure 67

**Proof** Assume there is a bigon or trigon of  $\Lambda$  on each side of an ESC on the corner (1234) as in Figure 66. We can find a bridge disk  $D$  for either (23) or (41) which is disjoint (in the exterior of  $K$ ) from both of these faces as well as the White face of the ESC. Let  $B_{12,34}$  be the annulus on  $\hat{F}$  to which the Black annulus  $A_{12,34}$  (arising from the ESC) is parallel by Lemma 16.6. Since  $\partial D \cap \hat{F}$  is disjoint from the edges of the ESC, it either lies inside  $B_{12,34}$  and is isotopic to an edge of the ESC or it lies entirely outside  $B_{12,34}$ . In either case, the parallelism of  $A_{12,34}$  to  $B_{12,34}$  along with  $D$  gives a thinning of  $K$ . □

**Lemma 16.9** *There cannot be five consecutive bigons.*

**Proof** Assume there are five consecutive bigons. Then by Lemma 16.8, they appear as MSMSM. No two of the M are parallel since otherwise either there would be a contradiction to Lemma 8.15 or the boundary of a Möbius band arising from one of the SCs would bound a disk in  $\hat{F}$ . Hence the two extending annuli of the two ESC are not parallel. In particular the annuli on  $\hat{F}$  to which they are boundary parallel by Lemma 16.6 have disjoint interiors. But since the two extending annuli share a spanning arc, the two boundary parallelisms cause it two sweep out a compressing disk for the handlebody that contains it. This disk however is a primitivizing disk for the annuli, contrary to Lemma 16.6. □

**Lemma 16.10** *There cannot be two ESCs extending the same color but differently labeled SCs.*

**Proof** Assume to the contrary that there are two ESCs as shown in Figure 68. Lemma 16.9 accounts for when they share a Black bigon. Indeed, using Lemma 16.6 and the fact that the boundaries of two Möbius bands cannot be isotopic in  $\hat{F}$  (no Klein bottle), a similar proof works when they do not share a bigon. □

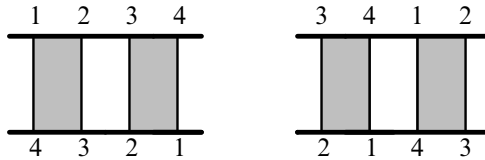

Figure 68

**Lemma 16.11** Any two ESCs of  $\Lambda$  extending SCs of the same labels must have their extending annuli parallel. In particular, the corresponding faces of these two ESCs are parallel (see Section 2.1).

**Proof** After relabeling, we may assume the two ESCs are labeled as in Figure 66. By Lemma 16.7, the SCs of these two ESCs have their edges parallel. Let  $A$  and  $A'$  be the extending annuli of the two ESCs. By Lemma 16.6, they are each  $\partial$ -parallel to annuli  $B$  and  $B'$ , respectively, in  $\widehat{F}$ . Let  $D_{12}$  and  $D'_{12}$  be bridge disks for (12) swept out by the parallelisms of  $A$  to  $B$  and  $A'$  to  $B'$  respectively. Assuming  $A$  and  $A'$  are not parallel,  $B \cup B'$  is a once-punctured torus. In particular,  $D_{12} \cup D'_{12}$  is a disk in the handlebody containing  $A$  and  $A'$  whose boundary transversally intersects each component of  $\partial A$  and  $\partial A'$  once. Thus  $A$  and  $A'$  are primitive in their handlebody, contradicting Lemma 16.6.  $\square$

**Lemma 16.12** If  $\Delta = 3$ , then at a vertex of  $\Lambda$  there cannot be two (1234)-ESC's and bigons at the remaining (12)- and (34)-corners. That is, there cannot be the configuration gMSMgMSMgBgB as shown in Figure 69.

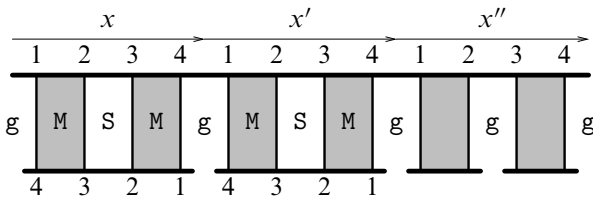

Figure 69

**Proof** Assume the configuration shown in Figure 69 is around a vertex  $x$  in  $\Lambda$ . Let  $A_{12,34}$  and  $A'_{12,34}$  be the Black annuli extending the two Möbius bands arising from the two SCs. By Lemma 16.6 and Lemma 16.11 they are parallel to one another and they are both  $\partial$ -parallel onto  $\widehat{F}$ . Let  $B$  be the union of the annuli on  $\widehat{F}$  to which  $A_{12,34}$  and  $A'_{12,34}$  are  $\partial$ -parallel. The edges of the two ESCs and the annulus  $B$  are shown in Figure 70 with the relevant labelings of edges.



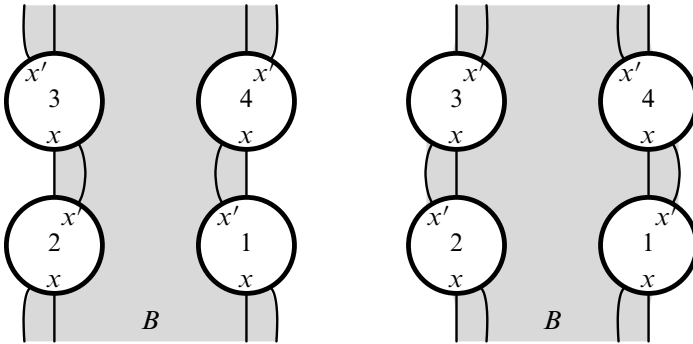

Figure 70

If one of the two remaining Black bigons were an M with an edge in  $B$ , then that edge would be parallel to an edge of each of the two ESCs. But then there would be three parallel edges that all have an endpoint labeled  $x$ , contradicting Lemma 8.15. If one of these bigons were an S with an edge in  $B$ , then it would form a Black Möbius band with boundary in  $B$ . This would imply the existence of an embedded Klein bottle, a contradiction. Thus the  $x''$  labels on all four vertices must be outside  $B$ . This however creates an ordering violation.  $\square$

**Lemma 16.13** *In  $\Lambda$  there cannot be an ESC and an FESC such that the two interior SCs are the same color but have different labels.*

**Proof** Assume otherwise. Then the ESC and FESC are either disjoint or coincide on one bigon, and so up to relabeling we may assume the ESC and FESC appear as in Figure 71. This FESC is the one shown in Figure 41(a). As in Figure 41(a), let  $f$  denote the Black bigon and  $g$  denote the Black trigon of this FESC. Its White bigon forms a White Möbius band  $A_{23}$ . Lemma 14.5 implies that the two  $\overline{14}$ -edges of it cobound a disk  $\delta$  in  $H_B$ .

The ESC gives rise to a White Möbius band  $A_{41}$  and a Black annulus  $A_{34,12}$ . By Lemma 16.6, this annulus  $A_{34,12}$  is  $\partial$ -parallel onto an annulus  $B_{34,12}$  on  $\widehat{F}$ . Either the trigon  $g$  is contained within this solid torus of parallelism  $\mathcal{T}$  between  $A_{34,12}$  and  $B_{34,12}$  or it is not.

**Case I** The trigon  $g$  lies within  $\mathcal{T}$ . Then the edges of  $g$  lie within the annulus  $B_{34,12}$ . The bigon  $f$  can neither lie within  $\mathcal{T}$  nor also be a bigon of the ESC. Otherwise  $\partial A_{23}$  would lie in  $B_{34,12}$  and we could form either an embedded  $\mathbb{R}P^2$  if it were inessential or an embedded Klein bottle if it were essential (since it would be parallel to  $\partial A_{41}$ ).

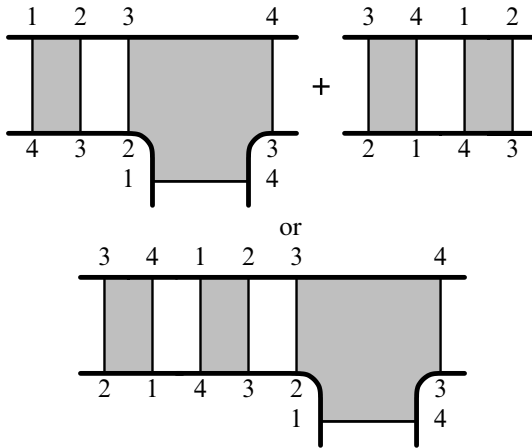

Figure 71

Since the  $\overline{41}$ -edge of  $g$  lies in  $B_{34,12}$ , it is parallel to a  $\overline{41}$ -edge of a Black bigon, say  $h$ , of the ESC. (By the preceding paragraph,  $h$  is necessarily distinct from  $f$ .) Then, since the  $\overline{41}$ -edges of  $f$  and  $g$  cobound the disk  $\delta$ , there must be a disk  $\delta'$  that the  $\overline{41}$ -edges of  $f$  and  $h$  bound. Furthermore we may assume the interior of  $\delta'$  is disjoint from  $A_{34,12}$ .

Because  $f$  lies outside  $\mathcal{T}$ , there are rectangles  $\rho_{12}$  and  $\rho_{34}$  on the boundaries of the 1-handle neighborhoods  $N((12))$  and  $N((34))$  between the corners of  $f$  and  $h$  that have interiors disjoint from  $\mathcal{T}$ . Then together  $f \cup \delta' \cup h \cup \rho_{12} \cup \rho_{34}$  forms a disk  $D$  whose boundary is the union of the  $\overline{23}$ -edges of  $f$  and  $h$  (and arcs of the boundaries of the fat vertices 2 and 3). We may now slightly lift the interior of  $D$  into  $H_B$  off  $\widehat{F}$  so that it is disjoint from  $A_{41}$ . Attach  $D$  to the White Möbius band  $A_{23}$  along the  $\overline{23}$ -edge of  $f$ . Then  $D \cup A_{23}$  is an embedded Möbius band in  $M$  that is disjoint from  $A_{41}$  and has boundary (formed of the  $\overline{23}$ -edges of  $g$  and  $h$ ) lying in  $B_{34,12}$ . As argued earlier, if this boundary were inessential we could form an embedded  $\mathbb{R}P^2$ , and if it were essential we could form an embedded Klein bottle. Neither of these may occur.

**Case II** The trigon  $g$  is not contained in  $\mathcal{T}$ . Then the edges of  $g$  meet the annulus  $B_{34,12}$  only at the vertices.

Assume  $f$  does not lie in  $\mathcal{T}$  (so that  $f$  is also not a bigon of the ESC). We follow the bridge disk construction of Lemma 14.9. There are rectangles that are disjoint from  $\mathcal{T}$ ,  $\rho_{12}$  and  $\rho_{34}$ , on the boundaries of the 1-handle neighborhoods  $N((12))$  and  $N((34))$  between corners of  $f$  and  $g$ , such that  $f \cup \delta \cup g \cup \rho_{12} \cup \rho_{34}$  forms a disk  $D$  whose interior may be lifted off  $A_{34,12}$  and  $\mathcal{T}$ . Note that the  $(34)$ -corner of  $g$

incident to the  $\overline{34}$ -edge of  $g$  cannot lie in the rectangle  $\rho_{34}$  since otherwise  $g$  would intersect the interior of  $\delta$ . Then  $\partial D$  intersects  $A_{34,12}$  only along the arc (34) (the (34) corner of  $g$  that was disjoint from  $\rho_{34}$ ) and at the vertex 2. A slight isotopy pulls  $D$  off vertex 2. Now attach a bridge disk  $D_{34}$  for the (34)-arc contained in  $\mathcal{T}$  to  $D$  along the (34)-arc. Then  $D' = D \cup D_{34}$  is a properly embedded disk in  $H_B$  that intersects  $B_{34,12}$  only in the spanning arc  $D_{34} \cap B_{34,12}$ . Hence  $D'$  is a primitivizing disk for the component  $\partial A_{41}$  of  $\partial B_{34,12}$ . However,  $\partial A_{41}$  cannot be primitive in  $H_B$  by Lemma 16.6.

Thus we must assume  $f$  lies in  $\mathcal{T}$ . Yet as in Case I (though using  $g$  instead of  $f$  there) there is a Black bigon  $h$  of the ESC so that the  $\overline{41}$ -edges of  $g$  and  $h$  together bound a disk  $\delta'$ . Using  $h$  and  $\delta'$  in lieu of  $f$  and  $\delta$  we may apply the previous argument to again conclude that  $\partial A_{41}$  is primitive in  $H_B$  contradicting Lemma 16.6.  $\square$

**Lemma 16.14** *There cannot be four bigons adjacent to a trigon.*

**Proof** If there were, then by Lemma 16.8 they must form an ESC and a FESC that share a bigon. Lemma 16.13 prohibits this configuration.  $\square$

### 16.3 More configurations of bigons and trigons

**Lemma 16.15** *Assume that at a vertex,  $x$ , of  $G_Q$  there is a configuration SMTM and another S on the same corner as the T. That is, WLOG assume we have the configurations of Figure 72. Then the edges of the length two and three (23)-Scharlemann cycles cannot lie in  $\widehat{F}$  in a subsurface which is a 3-punctured sphere or a 1-punctured torus. In particular, there cannot be two more  $\overline{41}$ -edges incident to  $x$ .*

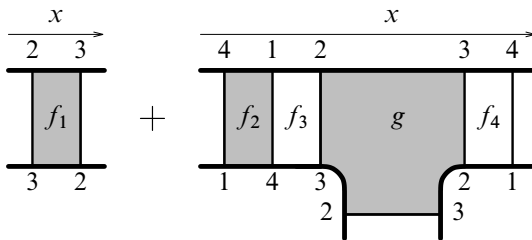

Figure 72

**Proof** Assume we have the configuration of Figure 72. Let  $A_{23}$  and  $A_{41}$  be the two Black Möbius bands arising from the two SCs. Let  $A_{12,34}$  be the White annulus

formed by joining  $f_3$  and  $f_4$  along the arcs (12) and (34). Write  $\partial A_{12,34} = \gamma_{23} \cup \gamma_{41}$ , where  $\gamma_{23}$  is the component formed from edges of  $g$ .

Let  $\Theta_{23}$  be the Black “twisted  $\theta$ -band” gotten by identifying the corners of the Scharlemann cycle trigon along the (23)-arc of  $K$ . By  $\partial\Theta_{23}$  we denote the  $\theta$ -graph formed from the three edges of the Scharlemann cycle trigon and the vertices 2 and 3 that is the intersection of  $\Theta_{23}$  with  $\widehat{F}$ .

The edges of  $f_1$  and  $g$ , as edges in  $G_F$ , cannot lie in a 3-punctured sphere. For by Lemma 8.15, the edges of  $f_1$  would have to be separating in this punctured sphere and this contradicts the labeling around vertices 2, 3 of the edges of  $g$ .

So we assume for contradiction that edges of  $f_1, g$  lie in a 1-punctured torus in  $\widehat{F}$ . But then there is a properly embedded disk  $D$  in  $H_B$  that separates  $A_{41}$  from  $A_{23}$  and  $\Theta_{23}$  and that is disjoint from  $K$  (in the boundary of the 3-manifold gotten by thickening the punctured torus, the (23)-arc of  $K$  and  $f_1, g$ ).

Then  $H_B - N(D)$  is two solid tori  $\mathcal{T}_{41}$  and  $\mathcal{T}_{23}$  containing  $A_{41}$  and  $A_{23} \cup \Theta_{23}$  respectively. The subgraph of  $G_F$  on  $\partial\mathcal{T}_{23}$  consisting of the vertices 2 and 3 and the edges of the two (23)-SCs has three parallel edges, two from  $g$  flanking one from  $f_1$  (use Lemma 8.15, the fact that  $\mathcal{T}_{23}$  is a solid torus, and the labeling at vertices 2, 3 of the edges of  $f_1, g$  on  $\partial\mathcal{T}_{23}$ ; also see Goda-Teragaito [14]). Furthermore  $\partial A_{23}$  lies in an annulus on  $\partial\mathcal{T}_{23}$  that runs twice longitudinally and  $\partial\Theta_{23}$  lies in an annulus running three time longitudinally along  $\mathcal{T}_{23}$  (consider the lens space resulting from attaching a 2-handle to  $\mathcal{T}_{23}$  along these annuli). We may take  $\gamma_{41}$  disjoint from  $D$  and contained in  $\partial\mathcal{T}_{41}$ . Since  $\gamma_{23} \subset \partial\Theta_{23}$ , it is either trivial on  $\partial\mathcal{T}_{23}$  or it runs three times longitudinally around  $\mathcal{T}_{23}$ . Furthermore, observe that (23) and (41) have bridge disks disjoint from  $D$  and  $A_{23} \cup \Theta_{23}$  and  $A_{41}$ .

If  $\gamma_{23}$  is trivial on  $\partial\mathcal{T}_{23}$ . Then it must be isotopic to  $\partial D$  on  $\widehat{F}$  since otherwise the two edges forming it would be parallel to a  $\overline{23}$ -edge of  $f_1$  violating Lemma 8.15. Thus  $A_{12,34}$  is separating and  $\partial$ -parallel (else  $H_B \cup D$  contains a lens space summand) onto a neighborhood of  $\partial D \subset \widehat{F}$ . Since there exists a bridge disk for (23) in  $\mathcal{T}_{23}$  disjoint from  $D$ , there is an isotopy of the arc (1234) onto  $\widehat{F}$  fixing the complementary arc (41). Hence  $K$  is at most 1-bridge, a contradiction.

Thus we assume  $\gamma_{23}$  runs three times longitudinally around  $\mathcal{T}_{23}$ . If  $\gamma_{41}$  bounds a disk  $D'$  on  $\partial\mathcal{T}_{41}$ , then  $N(D' \cup A_{12,34} \cup \mathcal{T}_{23})$  forms a punctured  $L(3, 1)$ . This cannot occur since  $M$  is irreducible and not a lens space. Hence  $\gamma_{41}$  is essential on  $\partial\mathcal{T}_{41}$ .

Let  $\mathcal{N} = \mathcal{T}_{23} \cup N(A_{12,34}) \cup \mathcal{T}_{41}$ . If  $\gamma_{41}$  is longitudinal on  $\partial\mathcal{T}_{41}$ , then  $\mathcal{N}$  is a solid torus containing  $K$  contradicting the hyperbolicity of  $K$ , that  $t = 4$ , or Lemma 3.3. Thus  $\mathcal{N}$  is a Seifert fiber space over the disk with two exceptional fibers. Hence  $M \setminus \mathcal{N}$

is a solid torus. Let  $H'_B = \mathcal{T}_{23} \cup N(f_3) \cup \mathcal{T}_{41}$  and note that, by using the bridge disks disjoint from the SCs,  $K$  is isotopic onto  $\partial H'_B$ . Viewing  $N(f_4)$  as a 1–handle attached to the solid torus  $M \setminus \mathcal{N}$ ,  $M \setminus H'_B = (M \setminus \mathcal{N}) \cup N(f_4)$  is a genus 2 handlebody. Hence  $K$  is 0–bridge with respect to this new genus 2 Heegaard splitting, a contradiction. Thus the edges of  $f_1, g$  do not lie on a 1–punctured torus in  $\hat{F}$ .

To prove the last sentence of the Lemma, note that the first part implies that all  $\overline{41}$ –edges must lie in an annulus on  $\hat{F}$ . Given two more  $\overline{41}$ –edges with an endpoint labeled  $x$ , then we have at least five such total. There is then a violation of Lemma 8.15.  $\square$

**Lemma 16.16** *Given a collection of bigons in  $G_Q$  as shown in Figure 73, then the two (34)–SCs must be parallel such that the two  $\overline{34}$ –edges of  $g$  and  $h$  are parallel.*

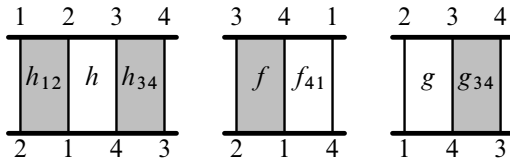

Figure 73

**Proof** Assume we do have the collection of bigons shown in Figure 73. Let  $f, g$  and  $h$  denote the bigons as shown. Let  $A_{12}$  and  $A_{34}$  be the Black Möbius bands arising from the two Black SCs  $h_{12}$  and  $h_{34}$  in the run of 3 bigons. Let  $A'_{34}$  be the Black Möbius band arising from the remaining Black SC  $g_{34}$ . Let  $A_{41}$  be the White Möbius band arising from the White SC  $f_{41}$ .

Chop open  $H_B$  along  $A_{12}$  and  $A_{34}$  to form the genus 2 handlebody  $H'_B$ . These leave annular impressions  $\tilde{A}_{12}$  and  $\tilde{A}_{34}$  that are each primitive on  $H'_B$ . The bigon  $f$  becomes a compressing disk that traverses the impressions  $\tilde{A}_{12}$  and  $\tilde{A}_{34}$  each once. Further chopping along  $f$  leaves a solid torus in which the SC  $g_{34}$  may only have two positions. Figure 74 shows the two possibilities of  $g_{34}$  in  $H'_B$  with respect to  $f$ . Reforming  $H_B$  by gluing  $\tilde{A}_{12}$  and  $\tilde{A}_{34}$  back into  $A_{12}$  and  $A_{34}$ , we observe that the two (34)–SCs either have no two edges parallel or are parallel.

Assume no pair of edges of the two Black  $\overline{34}$ –SCs are parallel as in Figure 74(b). The complement in  $\hat{F}$  of the subgraph of  $G_F$  induced by the edges of the Black bigons is seen to be one annulus and two disks. The annulus does not meet the vertices 1 or 2. Each disk meets each of the four vertices of  $G_F$ . Around the boundary of one disk we see the vertices in the cyclic order 143412; around the other we see 234321. The  $\overline{41}$ –edge of  $f$  appears as the subarcs of the boundary of the first disk joining the

$$H'_B = H_B \setminus (A_{12} \cup A_{34})$$

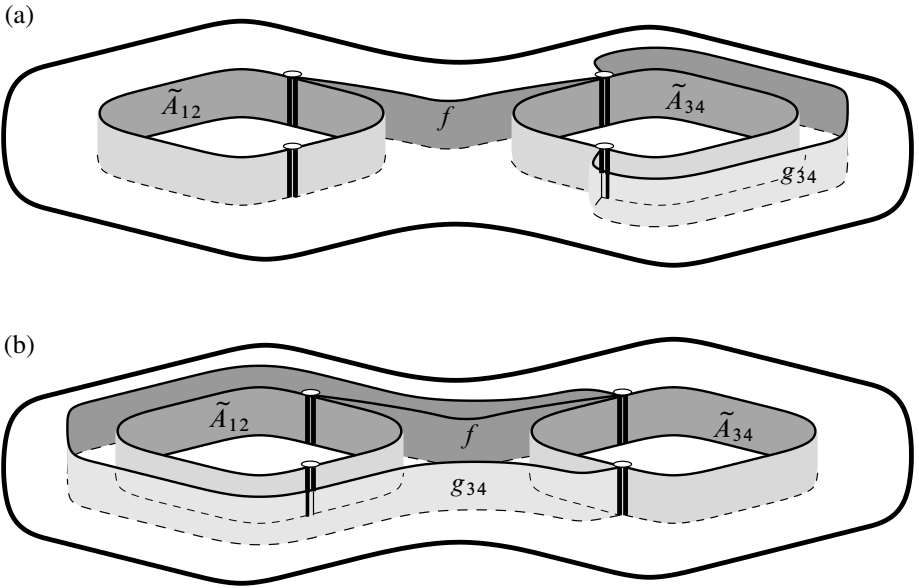

Figure 74

consecutive 1 and 4 vertices. The  $\overline{41}$ -edge of  $f_{41}$  that is not an edge of  $f$  cannot be in the first disk, since then  $\partial A_{41}$  would be isotopic to  $\partial A_{12}$  and a Klein bottle could be formed. Thus it must be an edge of the second disk, and this choice is unique.

We can now find bridge disks for the arcs (12) and (34) in  $H_B$  that guide isotopies of these arcs (rel  $\partial$ ) to arcs on  $\partial H_B$  that are disjoint from  $\partial A_{41}$  except at vertices 1 and 4, and which arcs are incident to  $\partial A_{41}$  on the same side. Furthermore, we see that  $\partial A_{41}$  is primitive in  $H_B$  (eg boundary compressing  $A_{12}$  along the above bridge disk for (12) gives a disk intersecting  $\partial A_{41}$  once). Attaching a neighborhood of  $A_{41}$  to  $H_B$  forms a new genus 2 handlebody  $H''_B$ , whose complement  $H''_W = H_W - N(A_{41})$  is a genus 2 handlebody. As in the argument of Lemma 14.9,  $K$  can be isotoped to be 1-bridge with respect to this new splitting (as the union of the arc (12341), properly isotopic to the bridge arc (23) in  $H''_W$ , and an arc in  $H''_B$  that is a cocore of the attaching annulus  $N(A_{41}) \cap H_B$ ). This contradicts the minimality of the presentation of  $K$ .

Hence the two (34)-SCs are parallel as in Figure 74(a). Assume the  $\overline{34}$ -edges of  $g$  and  $h$  are not parallel. Then after an isotopy of the  $\overline{34}$ -edge of  $g$ , these two edges form  $\partial A_{34}$ . Thus we may regard  $g \cup h$  as a White annulus  $A_{23,41}$  that has  $\partial A_{34}$  as a boundary component. Thus  $A_{34} \cup A_{23,41}$  is a long Möbius band as if it arose from an

ESC centered at a Black SC. The argument of Lemma 16.7 now applies to show that the Black bigon  $f$  should have been an SC.  $\square$

**Lemma 16.17** *There cannot be two triples of SMS on the same corner at a vertex of  $\Lambda$ .*

**Proof** Assume there are two such triples on the corner (2341) of a vertex of  $\Lambda$ . Then each triple contains a (23)–SC and a (41)–SC. By Lemma 16.2 either each pair of like-labeled SCs has a pair of parallel edges or one pair of the SCs is parallel.

Thus an outside edge of one triple must be parallel on  $G_F$  to an edge of the middle mixed bigon,  $f$ , of the other triple. Say this outside edge belongs to a (23)–SC of the first triple. Then the faces of the first triple, along with  $f$  and the (41)–SC of the second triple, can be used in the argument of Lemma 16.8 to find a thinning. (The two mixed bigons form the equivalent of an ESC about this (23)–SC).  $\square$

### 17 Lemma 17.1 and its proof

Throughout this section assume  $t = 4$ , there are no Dyck’s surfaces embedded in  $M$ , and we are in SITUATION NO SCC.

**Lemma 17.1** *Assume the configurations shown in Figure 75 appear in  $\Lambda$ . Then*

- (1)  $e_3$  is incident to opposite sides of  $e_2 \cup e_6$ ,
- (2)  $e_4$  is incident to opposite sides of  $e_1 \cup e_5$ ,
- (3)  $\partial A_{34}$  transversely intersects each component of  $\partial A_{12,34}$  once, and
- (4) neither  $f_0$  nor  $f_5$  is a bigon.

Here  $A_{34}$  is the Black Möbius band arising from the SC  $f_6$  and  $A_{12,34}$  is the Black annulus arising from gluing  $f_1$  and  $f_4$  together along (12) and (34).

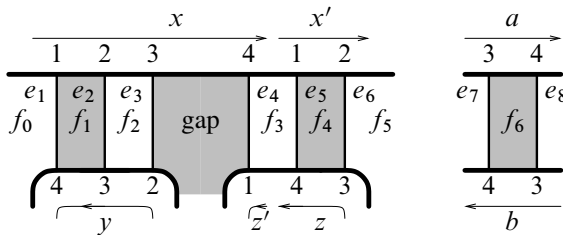

Figure 75

**Proof** In addition to forming the Black annulus  $A_{12,34}$  and Black Möbius band  $A_{34}$  from  $f_1$ ,  $f_4$  and  $f_6$ , the White SCs  $f_2$  and  $f_3$  form White Möbius bands  $A_{23}$  and  $A_{41}$  respectively. By Lemma 8.15, no component of  $\partial A_{12,34}$  is trivial in  $\hat{F}$ .

**Claim 17.2** *The annulus  $A_{12,34}$  is nonseparating in  $H_B$ .*

**Proof** Assume  $A_{12,34}$  is separating in  $H_B$ . Then  $\partial A_{12,34}$  bounds an annulus  $A$  in  $\partial H_B$ . Furthermore, no edge of  $G_F$  may be incident to opposite sides of either  $e_2 \cup e_6$  or  $e_1 \cup e_5$ .

**Subclaim 1a** Both  $e_3$  and  $e_4$  are disjoint from  $A$ .

**Proof** By labelings, if  $e_3$  is incident to just one side of  $e_2 \cup e_6$ , then  $e_4$  must be incident to just one side of  $e_1 \cup e_5$  as indicated in Figure 76(i), where neither  $e_3$  nor  $e_4$  lie in  $A$  or (ii), where both  $e_3$  and  $e_4$  lie in  $A$ . However in Figure 76(ii) either  $\partial A_{23}$  or  $\partial A_{41}$  is trivial in  $A$  or both are isotopic to the core of  $A$ ; hence an embedded  $\mathbb{R}P^2$  or Klein bottle may be created. (As drawn in Figure 76(ii),  $\partial A_{41}$  is trivial and a  $\mathbb{R}P^2$  may be created.) Thus the edges must appear as in Figure 76(i).  $\square$

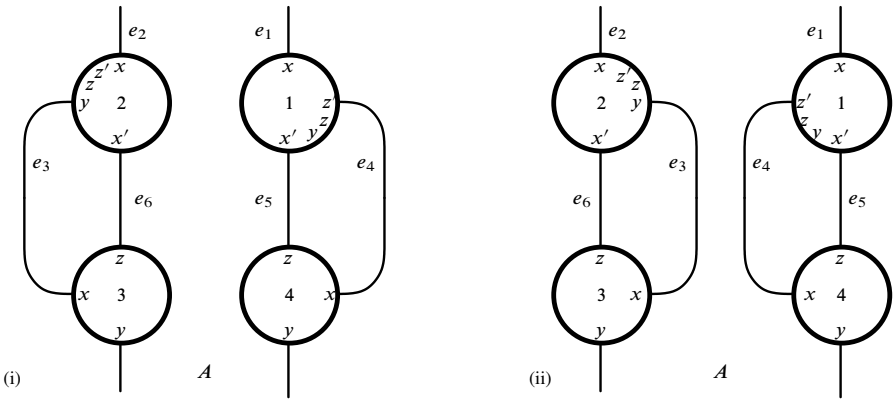

Figure 76

**Subclaim 1b** Both edges  $e_7$  and  $e_8$  of  $f_6$  are disjoint from  $A$ .

**Proof** By labelings, if either  $e_7$  or  $e_8$  were to lie in  $A$  then so would the other. Hence  $\partial A_{34}$  would be isotopic to the core of  $A$ . Thus  $A_{23}$ ,  $A_{34}$  and  $A_{41}$  are three disjoint Möbius bands, each properly embedded in either  $H_B$  or  $H_W$ . This contradicts Lemma 8.11.  $\square$



**Subclaim 1c** For  $i = 3, 4$ , let  $C_i$  be the corner on vertex  $i$  cobounded by the edges  $e_7$  and  $e_8$  of  $f_6$  that is disjoint from  $A$ . Then  $e_3$  must be incident to  $C_3$  and  $e_4$  must be incident to  $C_4$ . Consequently  $e_3$  is not parallel to either  $e_2$  or  $e_6$  and  $e_4$  is not parallel to either  $e_1$  or  $e_5$ .

**Proof** By labelings,  $e_3$  is incident to  $C_3$  if and only if  $e_4$  is incident to  $C_4$ . Thus assume neither is incident to  $C_3$  or  $C_4$ . Then we may perturb  $A_{34}$  to be disjoint from  $A_{23}$  and  $A_{41}$ . Again, this contradicts Lemma 8.11.

Since the edges  $e_7$  and  $e_8$  separate both  $e_3$  from  $e_2$  and  $e_6$  at vertex 3 and  $e_4$  from  $e_1$  and  $e_5$  at vertex 4, no pairs of these edges may be parallel. □

As a consequence of these subclaims, the subgraph of  $G_F$  induced by the edges  $e_1, \dots, e_8$  appear as in Figure 77 with possibly  $e_7$  and  $e_8$  swapped.

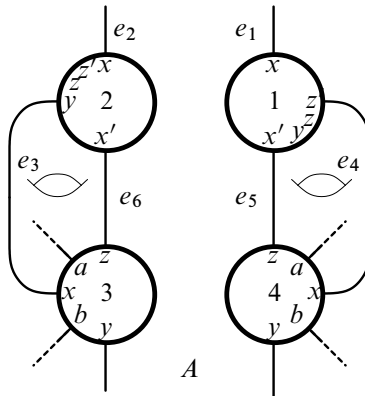

Figure 77

Note that  $P = N(A \cup e_3 \cup e_4) \subset \partial H_B$  is a 4-punctured sphere whose complement in  $\partial H_B$  is two annuli  $A_1$  and  $A_2$ . Moreover  $\partial A_{23}$  is isotopic to the core of one of these annuli and  $\partial A_{41}$  is isotopic to the core of the other; they cannot be isotopic to the same core since together they would form a Klein bottle. However, since  $e_8$  (or  $e_7$ ) lies outside of  $P$ , it lies in, say,  $A_1$ . But then  $A_1$  connects  $\partial A_{23}$  to  $\partial A_{41}$ .

This finishes the proof of Claim 17.2. □

**Claim 17.3**  $\partial A_{34}$  transversely intersects each component of  $\partial A_{12,34}$  just once.

**Proof** Assume otherwise. Then the subgraph of  $G_F$  induced by the edges of  $f_1$ ,  $f_4$  and  $f_6$  appears as in Figure 78 (disregard  $\delta$  and  $D$  for now).

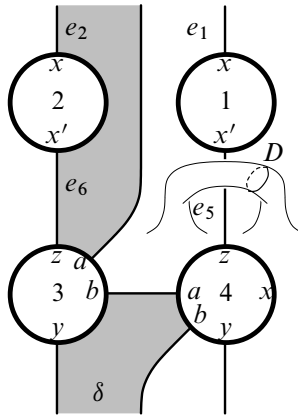

Figure 78

Note that  $\partial A_{34}$  may be perturbed to be disjoint from  $A_{12,34}$ . Since  $A_{12,34}$  is a Black annulus and  $A_{34}$  is a Black Möbius band, there is a nonseparating compressing disk  $D$  for  $H_B$  that is disjoint from both. Cutting  $H_B$  along  $D$  we obtain a solid torus  $\mathcal{T}$  in which  $A_{12,34}$  must be the boundary of a neighborhood around  $A_{34}$ . Thus some component of  $\partial A_{12,34}$  must be isotopic on  $\partial H_B$  to  $\partial A_{34}$ . As in Figure 78, let  $\delta$  be the region of  $\partial H_B$  giving this parallelism.

Note that if either  $e_3$  or  $e_4$  lies in  $\delta$  then it is parallel to an edge of  $\partial A_{12,34}$ . Then either  $A_{23}$  or  $A_{41}$  in union with  $A_{12,34}$  forms a long Möbius band. Assuming  $\delta$  is as shown in Figure 78, then  $e_3$  could lie in  $\delta$  and  $A_{23} \cup A_{12,34}$  would form the long Möbius band. By Proposition 16.5,  $\partial A_{23}$  must then be primitive in  $H_B$ . Yet since  $A_{12,34}$  is the boundary of a neighborhood around  $A_{34}$  in  $\mathcal{T}$ , neither component of  $\partial A_{12,34}$  may be primitive in  $H_B$ .

Thus we may assume neither  $e_3$  nor  $e_4$  may lie in  $\delta$ , and that  $\delta$  is as pictured in Figure 78. Therefore the two ends of  $e_3$  are incident to the same side of  $e_2 \cup e_6$ , and thus  $\partial A_{23}$  can be perturbed off  $\partial A_{12,34}$ . Then  $A_{23}$ ,  $A_{34}$  and  $A_{41}$  are disjoint Möbius bands contrary to Lemma 8.11. □

Without loss of generality, the subgraph of  $G_F$  induced by the edges of  $f_1$ ,  $f_4$  and  $f_6$  appears as in Figure 79.

Let  $N = N((12) \cup (34) \cup f_1 \cup f_4 \cup f_5) = N(A_{12,34} \cup A_{34})$ . Thus  $B = \partial N - \partial H_B$  is an annulus and  $A = \partial H_B - \partial N$  is an annulus. Also  $B \cup A = \partial \mathcal{T}$ , where  $\mathcal{T}$  is a solid torus in which  $A$  is longitudinal (since a bridge disk for (12), say, can be taken to be disjoint from  $f_1 \cup f_4 \cup f_6$ ). Thus there is a compressing disk for  $H_B$  transversely

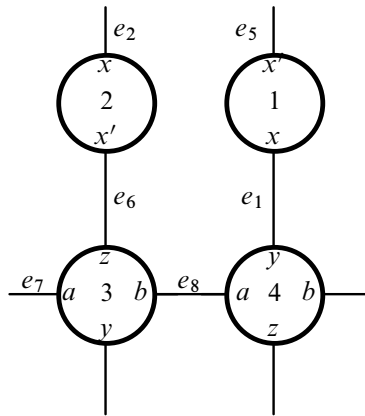

Figure 79

intersecting  $A_{12,34}$  once and each component of  $\partial A_{12,34}$  is primitive in  $H_B$ . Finally, note that  $N$  is a twisted  $I$ -bundle over a once-punctured Klein bottle.

**Claim 17.4** *The edge  $e_4$  is incident to opposite sides of the closed curve  $e_1 \cup e_5$ .*

**Proof** Assume both ends of  $e_4$  are incident to the same side of  $e_1 \cup e_5$ . Then both endpoints of  $e_4$  lie on the same component of  $\partial A$ . Since  $\partial A_{41}$  is not trivial in  $\partial H_B$ , either

- (1)  $e_4$  is parallel to  $e_1$ ,
- (2)  $\partial A_{41}$  is isotopic to the core of  $A$ , or
- (3)  $\partial A_{41}$  is isotopic to the 23-component of  $\partial A_{12,34}$ .

In (1),  $\partial A_{41}$  is isotopic to the 41-component of  $\partial A_{12,34}$ . Thus  $A_{41} \cup A_{12,34}$  forms a long Möbius band containing the arc (3412). Since there is a disk in  $H_B$  transversely intersecting  $A_{12,34}$  just once, we may form the handlebody  $H'_B = H_B \cup_{\partial A_{41}} N(A_{41})$  in which the arc (3412) is bridge. Since the White arc (23) has a bridge disk disjoint from  $A_{41}$ , removing  $N(A_{41})$  from  $H_W$  forms the handlebody  $H'_W = H_W - N(A_{41})$  in which (23) is bridge. Thus together  $H'_B$  and  $H'_W$  form a genus 2 Heegaard splitting of  $M$  in which  $K$  is 1-bridge. This contradicts the minimality of  $t$ .

In situation (2) we may form an embedded Dyck's surface by taking the 0-section of the twisted  $I$ -bundle  $N$  in union with  $A_{41}$ . Its existence is contrary to assumption.

Thus we are in situation (3) and we have the subgraph of  $G_F$  shown in Figure 80. This implies that the endpoints of the edge  $e_3$  must lie on the same side of  $e_2 \cup e_6$ . Hence

the same argument applied to  $e_4$  applies to  $e_3$  allowing us to conclude that  $\partial A_{23}$  must be isotopic to the 41–component of  $\partial A_{12,34}$ . Then together  $A_{23} \cup A_{12,34} \cup A_{41}$  form a Klein bottle in  $M$ .  $\square$

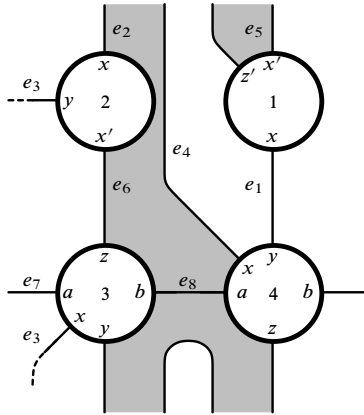

Figure 80

**Claim 17.5** The edge  $e_3$  is incident to opposite sides of the closed curve  $e_2 \cup e_6$ .

**Proof** The argument for Claim 17.4 applies analogously.  $\square$

**Claim 17.6** Neither  $f_0$  nor  $f_5$  is a bigon.

**Proof** We will show that  $f_0$  cannot be a bigon. The argument for  $f_5$  is the same.

Assume  $f_0$  is a bigon. Then it must be a 41–SC as shown in Figure 81. Let  $A'_{41}$  be the White Möbius band arising from  $f_0$ . We divide the argument into cases according to the relationships among the  $\overline{41}$ –edges of  $f_0$  and  $f_3$ .

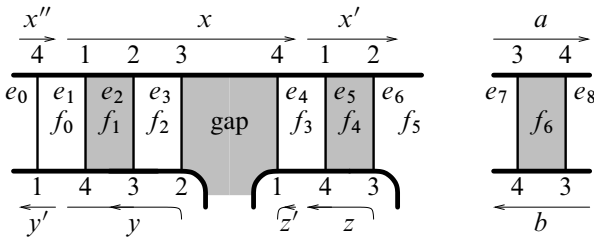

Figure 81

**Case I** No two edges of  $f_0$  and  $f_3$  are parallel in  $\partial H_B$ .

Then  $A_{41}$  and  $A'_{41}$  intersect transversely and a neighborhood in  $\partial H_B$  of the union of the edges of  $f_0$  and  $f_3$  is a 4-punctured sphere. (Otherwise  $A_{41}$  and  $A'_{41}$  could be isotoped to be disjoint from one another and from  $A_{23}$ ; two or three of these together then would form an embedded nonorientable surface in the handlebody  $H_W$ .) Yet by [Claim 17.5](#), these edges lie in a 1-punctured torus on  $\partial H_B$ . Hence one of the components of the 4-punctured sphere must bound a disk in  $\partial H_B$ . This however implies that two edges of  $f_0$  and  $f_3$  are parallel.

**Case II** Two edges of  $f_0$  and  $f_3$  are parallel in  $\partial H_B$ .

By [Lemma 8.15](#), it must be that either  $e_0$  is parallel to  $e_5$  or  $e_1$  is parallel to  $e_4$  on  $\partial H_B$ . Then either  $\partial A'_{41}$  or  $\partial A_{41}$  respectively is isotopic to the  $\overline{41}$ -component of  $\partial A_{12,34}$ . Hence we have a long Möbius band and may apply the argument of situation (1) in the proof of [Claim 17.4](#) to obtain a thinning of  $K$ . □

This completes the proof of [Lemma 17.1](#) □

## 18 SITUATION SCC for $t = 4$

Throughout this section we assume we are in SITUATION SCC for  $t = 4$ . [Theorem 18.11](#) will then show that  $t \neq 4$ .

We may assume there is a meridian disk  $D$  of  $\widehat{F}$  disjoint from  $K$  and  $Q$ . Let  $F^*$  be  $\widehat{F}$  surgered along  $D$ .

**Lemma 18.1** *The graph  $G_F$  lies in a single component  $\widehat{T}$  of  $F^*$ .*

**Proof** Otherwise  $F^*$  is two tori. Say  $D \subset H_W$  so that  $D$  cuts  $H_W$  into two solid tori  $\mathcal{T}_{23}$  and  $\mathcal{T}_{41}$ , each containing one arc of  $K$ , say (23) and (41) respectively. Then every White face of  $\Lambda$  is a SC and every Black face is not. Moreover every Black face is either a mixed bigon or has at least four sides. Finally, we may surger any disk face of  $G_Q$  so that its interior is disjoint from  $F^*$  (by [Corollary 3.2](#) and the strong irreducibility of the Heegaard splitting, an innermost curve of intersection is either a copy of  $D$  or bounds a meridian disk of  $\mathcal{T}_{23}$  or  $\mathcal{T}_{41}$  that is disjoint from  $K$ . In the former case we can surger the intersection away. The latter combines with [Corollary 5.4](#) to give the contradiction that  $M$  contains a lens space summand.)

The edges of any two White Scharlemann cycles of  $\Lambda$  of length at most three and on the same label pair, lie in exactly two parallelism classes in the graphs on  $\partial \mathcal{T}_{23}$  or  $\partial \mathcal{T}_{41}$ . Thus [Lemma 12.15](#) prevents there from being three or more bigon, trigon Scharlemann cycles at the (23)-corners of a vertex of  $\Lambda$  or at the (41)-corners of a

vertex of  $G_Q$ . In the language of special vertices (see below), this means there must be at least one true gap at a (23)–corner and at a (41)–corner of any special vertex.

Recall that two bigon faces of  $G_Q$  are said to be *parallel* if each edge of one is parallel to an edge of the other.

**Claim 18.2** *In  $\Lambda$  if a Black bigon is adjacent to a White bigon or trigon Scharlemann cycle, then all Black bigons are parallel. Moreover, at a vertex of  $\Lambda$ , at most two Black corners have bigons and these would have opposite labels.*

**Proof** To the contrary, assume  $\Lambda$  has two nonparallel mixed Black bigons  $f$  and  $g$  such that  $f$  shares an edge with a White bigon or trigon Scharlemann cycle. Note that neither edge of  $f$  is parallel on  $F^*$  to an edge of  $g$ , else the two Black faces can be combined to give a disk that contradicts Lemma 3.3 and the strong irreducibility of the Heegaard splitting. Then  $\mathcal{N} = N(f \cup (12) \cup (34) \cup \mathcal{T}_{23} \cup \mathcal{T}_{41})$  is a genus 2 handlebody in which  $K$  is isotopic to an arc on  $\partial\mathcal{N}$  and a bridge arc (using the bigon/trigon Scharlemann cycle that can be surgered to lie entirely in  $\mathcal{T}_{23}$  or  $\mathcal{T}_{41}$ ). Attaching  $N(g)$  to  $\mathcal{N}$  forms a Seifert fiber space over the disk with two exceptional fibers. (Otherwise  $K$  would be contained in the solid torus,  $N(g) \cup \mathcal{N}$ . As  $K$  is hyperbolic and  $M$  is not a lens space,  $K$  would have to be a core of this solid torus. But then  $K$  is 0–bridge with respect to  $H_W \cup H_B$ ). Then as usual  $M \setminus (\mathcal{N} \cup N(g))$  is a solid torus  $\mathcal{T}$ . So now  $\mathcal{N}$  and  $\mathcal{T} \cup N(g)$  form a genus 2 Heegaard splitting of  $M$  in which  $K$  is 1–bridge.

Given that all Black bigons are parallel, a vertex of  $\Lambda$  may have at most one Black bigon at a (12)–corner and one at a (34)–corner.  $\square$

**Remark 18.3** To make the proof of Claim 18.2 consistent with that of Theorem 2.6 we need to sharpen the argument to show that either Claim 18.2 holds (without changing the splitting) or  $M$  is a Seifert fiber space with an exceptional fiber of order 2 and furthermore that  $K$  is 1–bridge with respect to a vertical splitting of  $M$ . The argument given in Claim 18.2 applied to an ESC shows this. So we must show there is an ESC. We have shown that any black interval either belongs to a mixed bigon or corresponds to a true gap. We have also shown that there is a true gap at a (41)–corner and a (23)–corner. If there is no ESC then Lemma 5.12 shows that  $\Gamma$  has a special vertex of weight  $N = 4$ . The fact that there are at least two true gaps at this special vertex implies that there are at most three true gaps and one more corner which has a trigon. Between these four corners every other corner belongs to a bigon of  $\Gamma$ . First, note that if there is no ESC, then there is no triple of bigons. Otherwise on either side of this triple must be black gaps, hence true gaps, but then there are four true gaps (two black and two white). There is only one way that there is no triple of bigons, and that

is that  $\Delta = 3$  and there are exactly two bigons between each of these four corners. But this implies that two of these four corners are black, which along with the white gaps makes four true gaps. Thus there must be an ESC.

To finish the proof of [Lemma 18.1](#), [Claim 18.2](#) and [Lemma 8.15](#) imply that there cannot be 9 mutually parallel edges in  $\Lambda$ . By [Lemma 5.12](#),  $\Lambda$  must have a special vertex of length  $N = 4$ . Recall from the beginning of [Section 13](#), that a “true gap” is a corner of a special vertex that is not known to be a bigon or trigon. By [Lemma 5.14](#), the special vertex of  $\Lambda$  has at most three true gaps. If around a vertex of  $\Lambda$  there is a Black bigon adjacent to a White bigon or trigon (which are Scharlemann cycles), then [Claim 18.2](#) and [Lemma 8.15](#) imply at least 4 Black corners at the special vertex have true gaps (any Black face is a true gap or a bigon). Thus a special vertex of  $\Lambda$  must have any White bigon or trigon flanked by true gaps. But then, since there are at least two true gaps at White corners, this vertex must have at least 4 true gaps.  $\square$

Let  $\widehat{T}$  be as in [Lemma 18.1](#) and  $\mathcal{T}$  be the solid torus it bounds (gotten by surgering the Heegaard handlebody along  $D$ ). By possibly rechoosing  $D$ , we may assume that any disk face of  $G_Q$  may be surgered so that its interior is disjoint from  $\widehat{T}$  (as argued in the proof of [Lemma 18.1](#)).

**Lemma 18.4** *There cannot be two SCs of the same color but with different labels.*

**Proof** Otherwise the Möbius bands to which they give rise are disjoint and have parallel boundaries on  $\widehat{T}$ . From this we may construct an embedded Klein bottle.  $\square$

**Proposition 18.5** *There is no ESC.*

**Proof** Assume we do have an ESC as in [Figure 66](#). Let  $A_{23}$  be the associated White Möbius band and  $A_{12,34}$  be the Black annulus. We may take both to be properly embedded in  $\mathcal{T}$  or its exterior.

**Claim 18.6**  $D \subset H_B$

**Proof** If  $D \subset H_W$ , then  $A_{23}$  is contained in  $\mathcal{T}$ .

Set  $\mathcal{N} = \mathcal{T} \cup N(A_{12,34})$ . Observe that  $\mathcal{N}$  is a Seifert fiber space over the annulus with one exceptional fiber and that  $K \subset \mathcal{N}$ . Then  $\partial\mathcal{N}$  is two tori and one of these components must compress outside of  $\mathcal{N}$ . Such a compression produces a 2–sphere which must bound a 3–ball  $B$ . Since  $K \not\subset B$ ,  $\mathcal{N} \not\subset B$ . Therefore this torus bounds a solid torus  $\mathcal{T}'$  with interior disjoint from  $\mathcal{N}$ .

Assume  $\mathcal{N} \cup \mathcal{T}'$  is a solid torus. Since  $K$  is hyperbolic and  $M$  does not contain a lens space summand,  $K \subset \mathcal{N} \cup \mathcal{T}'$  must be isotopic to its core. That is,  $K$  is isotopic to a core curve of  $H_W$ . But then  $K$  is 0-bridge.

Thus  $\mathcal{N} \cup \mathcal{T}'$  must form a Seifert fiber space over the disk with two exceptional fibers. Hence  $M \setminus (\mathcal{N} \cup \mathcal{T}')$  is a solid torus  $\mathcal{T}''$ . Now we may form a genus 2 Heegaard splitting of  $M$  by taking  $H'_B = \mathcal{T}' \cup \text{N}(f_1) \cup \mathcal{T}''$  and  $H'_W = M \setminus H'_B = \mathcal{T} \cup \text{N}(f_3)$ . Then  $K \subset H'_W$  and  $K$  may be isotoped so that it is 1-bridge with respect to this Heegaard splitting. □

Since  $D \subset H_B$  by Claim 18.6,  $A_{12,34}$  is contained in  $\mathcal{T}$  of  $H_B \setminus D$ .

**Claim 18.7**  $\partial A_{23}$  is a longitude of  $\mathcal{T}$ .

**Proof** If it is not, then we may form a Seifert fiber space over the disk with two exceptional fibers  $\mathcal{N} = \mathcal{T} \cup \text{N}(A_{23})$ . Now apply Lemma 8.3 to produce a genus 2 Heegaard splitting of  $M$  in which  $K$  is 0-bridge. □

There can be no White mixed bigon. Otherwise  $K$  could be isotoped into  $\mathcal{T} \cup \text{N}(A_{23})$ , which is a solid torus by Claim 18.7. As  $K$  is hyperbolic and  $M$  contains no lens space summand,  $K$  is isotopic to a core of  $\mathcal{T} \cup \text{N}(A_{23})$ . But then the core,  $L$ , of the solid torus  $\mathcal{T}$  is a  $(2, 1)$ -cable of  $K$ . As  $L$  is a core of  $H_B$ , Claim 8.7 contradicts that  $t = 4$ .

There cannot be a White (41)-SC by Lemma 18.4. Consequently, there can be no bigon of  $\Lambda$  at a (41)-corner of a vertex in  $\Lambda$ . This prohibits there being 4 parallel edges at a vertex of  $\Lambda$ . Hence by Lemmas 5.12 and 5.14 there must be a special vertex  $v$  in  $\Lambda$ . Such a special vertex has at most 5 gaps (counting both trigons and true gaps).

Furthermore, around  $v$  there may only be two (23)-corners that have SCs. Otherwise, since  $\partial A_{12,34}$  bounds an annulus on  $\widehat{T}$ , there would be two edges of  $G_F$  that meet a vertex at the same label and are parallel on  $\widehat{T}$ . Lemma 12.15 prevents this.

Since  $D \subset H_B$  there can be no Black SCs. Otherwise one would give a Möbius band intersecting the separating annulus  $A_{12,34}$  transversely in a single arc in  $\mathcal{T}$ .

Thus in total,  $v$  must have at least  $\Delta$  gaps at all the (41)-corners and  $\Delta - 2$  gaps among the (23)-corners. Since  $v$  has at most 5 gaps, it must be the case that  $\Delta = 3$ . Hence with three gaps at the (41)-corners and one gap at a (23)-corner, either all three (12)-corners have a mixed bigon or all three (34)-corners have a mixed bigon. Yet since their edges must be parallel to the edges of  $\partial A_{12,34}$  on  $\mathcal{T}$ , there will have to be two edges parallel on  $\mathcal{T}$  that meet a vertex at the same label, in contradiction with Lemma 12.15. □



**Lemma 18.8** *There cannot be three consecutive bigons in  $\Lambda$ .*

**Proof** By Proposition 18.5, a triplet of bigons must be two SCs flanking a mixed bigon. But then these two SCs will have the same color and different labels, contrary to Lemma 18.4.  $\square$

**Lemma 18.9** *Assume  $\Lambda$  contains an FESC and let  $h$  be its SC. Then any bigon in  $\Lambda$  of the same color as  $h$  (Black or White) is a SC on the same label pair.*

**Proof** WLOG assume there is an FESC as in Figure 41(a). The graph induced by the edges of the FESC is shown abstractly in Figure 41(b). As mentioned above, any face of  $\Lambda$  can be taken to have interior disjoint from  $\widehat{T}$ .

First assume  $D \subset H_W$ . Since the graph of Figure 41(b) lies in  $\widehat{T}$ , one of  $\alpha$ ,  $\beta$ ,  $\alpha\beta$  bounds a disk in  $\widehat{T}$ . It cannot be  $\alpha$  since  $\alpha$  bounds a Möbius band  $A_{23}$ . If it were  $\beta$  then as in Lemma 14.9 we could form bridge disks that guided isotopies of the arcs (12) and (34) onto  $\widehat{T}$  so that  $K$  would be contained in  $\mathcal{T}$ . But then  $K$  is isotopic to a core of  $\mathcal{T}$ , and  $K$  is 0-bridge in the given Heegaard splitting. Thus  $\alpha\beta$  bounds a disk  $E$  in  $\widehat{T}$ .

Let  $\mathcal{N} = N((12) \cup (34) \cup f \cup g)$ . As shown in Claim 14.2,  $\mathcal{N} \cup N(E)$  is a trefoil complement (and the meridian of this trefoil complement is  $\partial A_{23}$ ). Then  $\mathcal{N}' = \mathcal{N} \cup N(E) \cup N(A_{23})$  has incompressible boundary  $T'$ . Therefore, by Lemma 8.1,  $\mathcal{T}' = M \setminus \mathcal{N}'$  is a solid torus.  $K$  intersects  $\mathcal{T}'$  in only the arc (41). By Lemma 8.2 (and that  $K$  is not locally knotted),  $T' - N(K)$  compresses in  $\mathcal{T}' - N(K)$  to show that (41) is  $\partial$ -parallel in  $\mathcal{T}'$ . ( $T' - N(K)$  cannot compress into  $\mathcal{N}'$  since that would imply the arc  $K \cap \mathcal{N}'$  and hence  $K$  is isotopic into  $\mathcal{T}'$ . But then  $T'$  would be an essential torus in the exterior of  $K$ , a contradiction.)

Since  $\alpha$  is a primitive curve on  $\mathcal{N}$  by Claim 14.2,  $\mathcal{N} \cup N(A_{23})$  is a genus 2 handlebody,  $H'_B$ . On the other hand, the complement of  $H'_B$  is a genus two handlebody,  $H'_W$  (the union of  $\mathcal{T}'$  and a 1-handle dual to  $E$ ). As in the proof of Claim 14.8,  $K$  can be written as the union of two arcs: (34123),  $\kappa$ . Here  $\kappa$  is  $K \cap H'_B$  and is properly isotopic in  $H'_B$  to a cocore of the annulus  $N(\partial A_{23}) \cap \mathcal{N}$ . As  $\partial A_{23}$  primitive in  $\mathcal{N}$ ,  $\kappa$  is a bridge arc in  $H'_B$ . On the other hand, the arc (34123) is  $K \cap H'_W$  and is properly isotopic in  $H'_W$  to (41). As (41) is bridge in  $\mathcal{T}'$ , it is bridge in  $H'_W$ . Thus  $K$  is 1-bridge with respect to a genus 2 splitting of  $M$ .

**Remark 18.10** This is one of the special cases of the proof of Theorem 2.6. Here  $M$  is  $n/2$ -surgery on the trefoil (and hence a Seifert fiber space over the 2-sphere with an exceptional fiber of order 2 and one of order 3). The argument presents  $K$  as

1-bridge with respect to the splitting of  $M$  gotten from a genus 2 Heegaard splitting of the trefoil exterior: ie remove a neighborhood of the unknotting tunnel from the exterior of the trefoil for one handlebody of the splitting, then the filling solid torus in union with a neighborhood of the unknotting tunnel is the other.

If  $D \subset H_B$ , then the first part of the argument of [Claim 14.8](#) shows that  $\partial A_{23}$  is longitudinal in  $\mathcal{T}$ . Thus  $\mathcal{N}' = \mathcal{T} \cup N(A_{23})$  is a solid torus. Let  $l$  be a bigon of  $\Lambda$  of the same color as  $h$ , that is a White bigon. If  $l$  is a mixed bigon, then  $l$  guides an isotopy of  $K$  into the solid torus  $\mathcal{N}'$ . As  $K$  is hyperbolic and  $M$  contains no lens space summand,  $K$  can be isotoped to be a core of  $\mathcal{N}'$ . But the core,  $L$ , of  $\mathcal{T}$  is a  $(2, 1)$ -cable of  $K$  (in  $\mathcal{N}'$ ). As  $L$  is a core of  $H_B$ , [Claim 8.7](#) contradicts that  $t = 4$ . Thus  $l$  cannot be a mixed bigon. By [Lemma 18.4](#),  $l$  must be a SC on the same label pair as  $h$ .  $\square$

**Theorem 18.11** *In SITUATION SCC,  $t \neq 4$ .*

**Proof** By [Lemma 18.8](#),  $\Lambda$  cannot have a triple of bigons. Hence by [Lemma 5.12](#) there must be a special vertex  $v$  in  $\Lambda$ . By [Lemma 5.14](#), such a special vertex has at most 5 gaps (counting both trigons and true gaps). That is, there are at most 5 corners at  $v$  that do not belong to bigons of  $\Lambda$ . Furthermore  $v$  must be of type  $[8, 1]$  with  $\Delta = 3$  or type  $[7, 4]$  with  $\Delta = 3$ , else it must have a triple of bigons.

If the special vertex  $v$  has type  $[7, 4]$ , then there are five gaps. Having no triple of bigons implies there must be at least two instances of adjacent bigons flanked by gaps. First assume there is no sequence TBBT at  $v$  (notation as described at the beginning of [Section 13](#)). Then there must be a TBBGBBT. Lemmas [18.4](#) and [18.9](#) force this to be TSMGMST. Again applying Lemmas [18.4](#) and [18.9](#), we must have TTSMGMSTT. But then there is a triple of bigons at  $v$ , contradicting [Lemma 18.8](#). So assume there is a sequence TBBT at  $v$ . By Lemmas [18.4](#) and [18.9](#), we may assume we have TMSTg, where the MST is an FESC. There must be at least two more bigon pairs, BB. In particular there must be a sequence gBBgBBg, possibly including part of the above sequence. As argued above, the existence of the FESC forces ggSMgMSgg and hence a triple of bigons, a contradiction.

If the special vertex has type  $[8, 1]$ , then there are four gaps. Having no triple of bigons implies that the gaps occur at every third corner separating four pairs of adjacent bigons. There is now no way to label these bigons without violating [Lemma 18.4](#).  $\square$

## Appendix A: Small Seifert fiber spaces containing a Dyck's surface

This appendix proves [Theorem A.2](#), which restricts the small Seifert fiber spaces containing a Dyck's surface.

In what follows a *surface* will always be connected.

**Definition A.1**  $M = S^2(s_1/t_1, s_2/t_2, s_3/t_3)$  is defined as follows. Let  $\tilde{M} = S^1 \times F$ , where  $F$  is a pair of pants. An orientation on each of the factors induces coordinates  $(s, t)$ , where  $s$  is the number of times around the  $S^1$  factor. To each component of  $\partial\tilde{M}$  attach a solid torus  $T_i$  so that the meridian of  $T_i$  is identified with the curve  $(s_i, t_i)$ . The resulting manifold is  $M$ .  $\tilde{M}$  is a circle bundle,  $p: \tilde{M} \rightarrow F$ .  $M$  is a Seifert fiber space over  $S^2$ , where each  $T_i$  is a neighborhood of an exceptional fiber of order  $t_i$ .

**Theorem A.2** *Let  $M$  be a SFS over the 2-sphere with three exceptional fibers. If  $M$  contains an incompressible Dyck's surface, then either*

- (A)  $M = S^2(2/p_1, 2/p_2, 2/p_3)$ , where each  $p_i$  is an odd integer; or
- (B) one of the exceptional fibers of  $M$  has order 2 and a second has order which is a multiple of 4; or
- (C)  $M$  has exceptional fibers of order 2 and 3. In fact,  $M$  is  $(2/n)$ -surgery on a trefoil knot; or
- (D)  $M$  has two exceptional fibers of order 2. In this case  $M$  contains a Klein bottle; or
- (E)  $M$  has two exceptional fibers of order 3.

**Remark A.3** The Teragaito examples are in  $S^2(-1/2, 1/6, 2/7)$ , which by the above does not contain a Dyck's surface.

**Proof** Let  $K$  be an incompressible Dyck's surface in  $M$ . [12, Theorem 2.5] shows that  $K$  can be isotoped to be either pseudovertical or pseudohorizontal.  $K$  is said to be *pseudovertical* if  $\tilde{K} = K \cap \tilde{M}$  is a vertical annulus whose boundary lies in distinct components of  $\partial\tilde{M}$ ,  $\partial T_i$ ,  $\partial T_j$ ; furthermore,  $K \cap T_i$  and  $K \cap T_j$  are one-sided incompressible surfaces in  $T_i$  and  $T_j$ .  $K$  is said to be *pseudohorizontal* if  $K \cap \tilde{M}$  is horizontal under the circle fibration and  $K$  intersects each of  $T_1, T_2, T_3$  in either a family of meridian disks or in a one-sided incompressible surface. Note that by [12, Corollary 2.2], a one-sided incompressible surface in a solid torus has a single boundary component.  $\square$

**Claim A.4** *If  $K$  is pseudohorizontal then one of the conclusions to [Theorem A.2](#) holds.*

**Proof** Assume  $K$  is pseudohorizontal. Then  $p: \tilde{K} \rightarrow F$  is a cover of index  $\lambda \geq 1$ . Note that  $\lambda$  is the intersection number of  $\tilde{K}$  with any circle fiber of  $\tilde{M}$ .

Assume  $\lambda = 1$ . Then a component  $c$  of  $\partial\tilde{K}$  would intersect the Seifert fiber in the neighborhood of the corresponding exceptional fiber once. This immediately implies that  $c$  does not bound a meridian of that solid torus neighborhood. Thus  $K$  intersects the neighborhood of an exceptional fiber in a single one-sided incompressible surface. As the Euler characteristic of  $K$  is  $-1$ , it must be that  $K$  intersects the neighborhood of each of the exceptional fibers of  $M$  in a Möbius band. As  $\tilde{K}$  is a section for the circle bundle we can use it to define the product structure on  $\tilde{M}$ . This gives coordinates on the boundary of each exceptional fiber so that  $\tilde{K} \cap \partial T_i$  is  $(0, 1)$  and the circle fiber (which is the Seifert fiber of  $M$ ) is  $(1, 0)$ . As  $K \cap T_i$  is a Möbius band, its boundary must intersect the meridian of the solid torus twice. Thus in these coordinates, the meridian is  $(2, p_i)$  where  $|p_i|$  is the order of the exceptional fiber (and odd). Thus  $M = S^2(2/p_1, 2/p_2, 2/p_3)$  and we have conclusion (A) above.

Assume  $\lambda > 1$ . As  $K$  is 1-sided it cannot intersect all of the  $T_i$  in disks. On the other hand, since  $\tilde{K}$  is a  $\lambda$ -fold cover of the pair of pants  $F$ , it must have Euler characteristic  $-\lambda$ . Thus  $K$  must intersect some  $T_i$  in disks.

Assume first that  $K$  intersects only  $T_1$  in disks. Let  $r \leq 0$  be the sum of the Euler characteristics of the one-sided surfaces  $K \cap T_2, K \cap T_3$ . Then  $-1 = \chi(K) = -\lambda + \lambda/p + r$ , where  $p$  is the order of the singular fiber at  $T_1$ . This implies that  $r = 0$  and  $\lambda(p-1) = p$ . As  $\lambda$  is a multiple of  $p$ , this implies that  $\lambda = p = 2$ . But then we conclude that  $\tilde{K}$  has exactly three boundary components and Euler characteristic  $-2$ . This implies that  $\tilde{K}$  is nonorientable. But  $\tilde{K}$  covers the orientable  $F$ .

So assume  $K$  intersects  $T_1, T_2$  in disks and  $T_3$  in a 1-sided surface with Euler characteristic  $r \leq 0$ . Let  $p_1, p_2$  be the orders of the singular fibers of  $T_1, T_2$ . Then we have the following equality (\*):  $-1 = \chi(K) = -\lambda + \lambda/p_1 + \lambda/p_2 + r$ .

**Claim A.5** *One of the following must hold:*

- (1)  $r = -1$  and  $p_1 = p_2 = 2$ ; or
- (2)  $r = 0, p_1 = 2, p_2 = 3$  and  $\lambda = 6$ ; or
- (3)  $r = 0, p_1 = 2, p_2 = 4$  and  $\lambda = 4$ ; or
- (4)  $r = 0, p_1 = 3 = p_2$  and  $\lambda = 3$ .

**Proof** Noting that  $\lambda$  is a multiple of both  $p_1$  and  $p_2$ , define the natural numbers  $e_1 = \lambda/p_1, e_2 = \lambda/p_2$ .

Assume that  $r \leq -1$ . Then (\*) implies that  $p_1 p_2 \leq p_1 + p_2$ , hence  $p_1 = p_2 = 2$  and  $r = -1$ , giving conclusion (1).

We hereafter take  $r = 0$ . WLOG assume  $p_2 \geq p_1$  and hence  $e_1 \geq e_2$ .

First assume  $p_1 > 2$ . Then  $2e_1 < \lambda = e_1 + e_2 + 1$  from (\*); hence,  $e_1 < e_2 + 1$ . Thus  $e_1 = e_2, p_1 = p_2$ . Then (\*) becomes  $\lambda((p_1 - 2)/p_1) = 1$  or that  $e_1(p_1 - 2) = 1$ . This gives conclusion (4) above.

So assume  $p_1 = 2$ . Then we get that  $e_2(p_2 - 2) = 2$ . This means that either  $e_2 = 2, p_2 = 3, \lambda = 6$  or  $e_2 = 1, p_2 = 4, \lambda = 4$ . These are conclusions (2) and (3).  $\square$

**Claim A.4** now follows from **Claim A.5**: Conclusion (1), (2), (3), (4) of **Claim A.5** imply conclusions (D), (C), (B), (E), respectively. Note that in conclusion (D),  $M$  contains a pseudovertical Klein bottle between the exceptional fibers of order 2. In the context of conclusion (2) of the claim (which is the context of (C) in the Theorem)  $X = M - \text{Int}(T_3)$  is the exterior of a trefoil knot and  $K \cap X$  is a 1-punctured torus, hence a Seifert surface for  $X$ . As  $T_3$  intersects  $K$  in a Möbius band, the meridian of  $T_3$  intersects the boundary of this Seifert surface twice. Hence  $M$  is an  $(2/n)$ -filling of  $X$  as claimed.  $\square$

**Claim A.6** If  $K$  is pseudovertical then conclusion (B) of **Theorem A.2** holds.

**Proof** Assume  $K$  is pseudovertical. As  $\chi(K) = -1$ ,  $K$  is the union of a vertical annulus  $\tilde{K}$  and a Möbius band  $K_1$  in  $T_1$  (say) along with a punctured Klein bottle  $K_2$  in  $T_2$  (say).

Now  $\partial K_1$  will intersect the meridian of  $T_1$  twice. As  $\partial K_1$  is a Seifert fiber of  $M$  this says that the order of the exceptional fiber at  $T_1$  is 2.

By [12, Corollary 2.2], a one-sided incompressible surface in a solid torus has boundary a single  $(2k, l)$ -curve in longitude, meridian coordinates of the solid torus where  $k, l$  are integers and  $k > 0$ . In [6], a recursive formula is developed for  $N(2k, l)$ , which, as pointed out in [12], is equal to the cross-cap number of the (unique) 1-sided incompressible surface whose boundary is the  $(2k, l)$ -curve. By picking the right longitude, we may assume that  $k > l > 0$  in the computation of  $N(2k, l)$ . Then [6, (6.4)] shows that  $N(2k, l) = 2$  iff  $k$  is even. So let  $\partial K_2$  be such a  $(2k, l)$  curve in  $T_2$ . Then  $2 = N(2k, l)$  and  $k$  is even. As  $\partial K_2$  is a Seifert fiber for  $M$ , this implies that the exceptional fiber for  $T_2$  has order  $2k$  with  $k$  even.

Thus  $M$  is as in **Theorem A.2(B)**.  $\square$

## References

- [1] **KL Baker**, *Small genus knots in lens spaces have small bridge number*, *Algebr. Geom. Topol.* 6 (2006) 1519–1621 [MR2253458](#)
- [2] **KL Baker, CM Gordon, J Luecke**, *Bridge number and integral Dehn surgery* [arXiv:1303.7018](#)
- [3] **KL Baker, CM Gordon, J Luecke**, *Bridge number, Heegaard genus and non-integral Dehn surgery* [arXiv:1202.0263](#)
- [4] **J Berge**, *Some knots with surgeries yielding lens spaces*, unpublished manuscript
- [5] **S Boyer, X Zhang**, *On Culler–Shalen seminorms and Dehn filling*, *Ann. of Math.* 148 (1998) 737–801 [MR1670053](#)
- [6] **GE Bredon, JW Wood**, *Non-orientable surfaces in orientable 3–manifolds*, *Invent. Math.* 7 (1969) 83–110 [MR0246312](#)
- [7] **AJ Casson, CM Gordon**, *Reducing Heegaard splittings*, *Topology Appl.* 27 (1987) 275–283 [MR918537](#)
- [8] **JC Cha, C Livingston**, *KnotInfo: Table of Knot Invariants* (2010) Available at <http://www.indiana.edu/~knotinfo>
- [9] **M Culler, CM Gordon, J Luecke, PB Shalen**, *Dehn surgery on knots*, *Bull. Amer. Math. Soc.* 13 (1985) 43–45 [MR788388](#)
- [10] **MEudave Muñoz**, *On nonsimple 3–manifolds and 2–handle addition*, *Topology Appl.* 55 (1994) 131–152 [MR1256216](#)
- [11] **GK Francis**, *On knot-spanning surfaces: An illustrated essay on topological art*, from: “The visual mind”, (M Emmer, editor), MIT Press, Cambridge, MA (1993) 57–64 [MR1255839](#)
- [12] **C Frohman**, *One-sided incompressible surfaces in Seifert fibered spaces*, *Topology Appl.* 23 (1986) 103–116 [MR855450](#)
- [13] **D Gabai**, *Foliations and the topology of 3–manifolds, III*, *J. Differential Geom.* 26 (1987) 479–536 [MR910018](#)
- [14] **H Goda, M Teragaito**, *Dehn surgeries on knots which yield lens spaces and genera of knots*, *Math. Proc. Cambridge Philos. Soc.* 129 (2000) 501–515 [MR1780501](#)
- [15] **CM Gordon**, *Combinatorial methods in Dehn surgery*, from: “Lectures at KNOTS”, (S Suzuki, editor), Ser. Knots Everything 15, World Sci. Publ., River Edge, NJ (1997) 263–290 [MR1474525](#)
- [16] **CM Gordon, RA Litherland**, *Incompressible planar surfaces in 3–manifolds*, *Topology Appl.* 18 (1984) 121–144 [MR769286](#)
- [17] **CM Gordon, RA Litherland**, *Incompressible surfaces in branched coverings*, from: “The Smith conjecture”, (JW Morgan, H Bass, editors), Pure Appl. Math. 112, Academic Press, Orlando, FL (1984) 139–152 [MR758466](#)

- [18] **C M Gordon, J Luecke**, *Only integral Dehn surgeries can yield reducible manifolds*, Math. Proc. Cambridge Philos. Soc. 102 (1987) 97–101 [MR886439](#)
- [19] **C M Gordon, J Luecke**, *Knots are determined by their complements*, J. Amer. Math. Soc. 2 (1989) 371–415 [MR965210](#)
- [20] **C M Gordon, J Luecke**, *Dehn surgeries on knots creating essential tori, I*, Comm. Anal. Geom. 3 (1995) 597–644 [MR1371211](#)
- [21] **C M Gordon, J Luecke**, *Dehn surgeries on knots creating essential tori, II*, Comm. Anal. Geom. 8 (2000) 671–725 [MR1792371](#)
- [22] **C M Gordon, J Luecke**, *Non-integral toroidal Dehn surgeries*, Comm. Anal. Geom. 12 (2004) 417–485 [MR2074884](#)
- [23] **W Haken**, *Some results on surfaces in 3-manifolds*, from: “Studies in Modern Topology”, (P Hilton, editor), Math. Assoc. Amer. (1968) 39–98 [MR0224071](#)
- [24] **A E Hatcher**, *On the boundary curves of incompressible surfaces*, Pacific J. Math. 99 (1982) 373–377 [MR658066](#)
- [25] **J Hempel**, *3-manifolds as viewed from the curve complex*, Topology 40 (2001) 631–657 [MR1838999](#)
- [26] **M Lackenby, R Meyerhoff**, *The maximal number of exceptional Dehn surgeries*, Invent. Math. 191 (2013) 341–382 [MR3010379](#)
- [27] **Y N Minsky, Y Moriah, S Schleimer**, *High distance knots*, Algebr. Geom. Topol. 7 (2007) 1471–1483 [MR2366166](#)
- [28] **Y Moriah, H Rubinstein**, *Heegaard structures of negatively curved 3-manifolds*, Comm. Anal. Geom. 5 (1997) 375–412 [MR1487722](#)
- [29] **K Morimoto, M Sakuma, Y Yokota**, *Identifying tunnel number one knots*, J. Math. Soc. Japan 48 (1996) 667–688 [MR1404816](#)
- [30] **Y Rieck**, *Heegaard structures of manifolds in the Dehn filling space*, Topology 39 (2000) 619–641 [MR1746912](#)
- [31] **Y Rieck, E Sedgwick**, *Finiteness results for Heegaard surfaces in surgered manifolds*, Comm. Anal. Geom. 9 (2001) 351–367 [MR1846207](#)
- [32] **Y Rieck, E Sedgwick**, *Persistence of Heegaard structures under Dehn filling*, Topology Appl. 109 (2001) 41–53 [MR1804562](#)
- [33] **M Scharlemann**, *Local detection of strongly irreducible Heegaard splittings*, Topology Appl. 90 (1998) 135–147 [MR1648310](#)
- [34] **M Teragaito**, *A Seifert fibered manifold with infinitely many knot-surgery descriptions*, Int. Math. Res. Not. 2007 (2007) [MR2347296](#)
- [35] **A Thompson**, *Thin position and bridge number for knots in the 3-sphere*, Topology 36 (1997) 505–507 [MR1415602](#)

- [36] **A Thompson**, *The disjoint curve property and genus 2 manifolds*, *Topology Appl.* 97 (1999) 273–279 [MR1711418](#)
- [37] **M Tomova**, *Distance of Heegaard splittings of knot complements*, *Pacific J. Math.* 236 (2008) 119–138 [MR2398991](#)
- [38] **HF Trotter**, *Non-invertible knots exist*, *Topology* 2 (1963) 275–280 [MR0158395](#)

KB: *Department of Mathematics, University of Miami*  
*PO Box 249085, Coral Gables, FL 33146, USA*

CG,JL: *Department of Mathematics, University of Texas at Austin*  
*1 University Station C1200, Austin, TX 78712-1202, USA*

[k.baker@math.miami.edu](mailto:k.baker@math.miami.edu), [gordon@math.utexas.edu](mailto:gordon@math.utexas.edu),  
[luecke@math.utexas.edu](mailto:luecke@math.utexas.edu)

<http://math.miami.edu/~kenken>,  
<http://www.ma.utexas.edu/text/webpages/gordon.html>

Received: 1 May 2012      Revised: 6 February 2013