

Compact Stein surfaces as branched covers with same branch sets

TAKAHIRO OBA

For each integer $N \geq 2$, we construct a braided surface $S(N)$ in D^4 and simple branched covers of D^4 branched along $S(N)$ such that the covers have the same degrees and are mutually diffeomorphic, but Stein structures associated to the covers are mutually not homotopic. As a corollary, for each integer $N \geq 2$, we also construct a transverse link $L(N)$ in the standard contact 3–sphere and simple branched covers of S^3 branched along $L(N)$ such that the covers have the same degrees and are mutually diffeomorphic, but contact manifolds associated to the covers are mutually not contactomorphic.

57M12, 57R17; 32Q28, 57R65

1 Introduction

A *compact Stein surface* is a sublevel set of an exhausting strictly plurisubharmonic function on a 2–dimensional complex manifold. Such complex surfaces have been studied by using complex and symplectic geometry. For example, Eliashberg [9] characterized handle decompositions of compact Stein surfaces, and Gompf [14] described how to draw Kirby diagrams of them. Since the early 2000s, the study of them was dramatically altered after the seminal works of Loi and Piergallini [21] and Akbulut and Ozbagci [1]. They showed that a smooth, oriented, compact 4–manifold X with boundary admits a Stein structure if and only if X admits a *positive allowable Lefschetz fibration* $f: X \rightarrow D^2$; see Section 2.3. It is known that Lefschetz fibrations are studied through mapping class groups, so group-theoretical approaches help us to deal with compact Stein surfaces. For example, such techniques yield a family of contact 3–manifolds with infinitely many Stein fillings; see Baykur and Van Horn-Morris [3; 4], Dalyan, Korkmaz and Pamuk [8] and Ozbagci and Stipsicz [24]. For broader results, we refer the reader to Ozbagci [23] for a survey on this subject.

Loi and Piergallini also showed that a smooth, oriented, compact 4–manifold X with boundary admits a Stein structure if and only if X is a simple branched cover of

a 4–disk D^4 branched along a *positive braided surface* S ; see Definitions 2.1 and 2.2. Unfortunately, although the fact is well known, little is known about how Stein structures behave with respect to positive braided surfaces. We can describe braided surfaces by using combinatorial tools such as chart descriptions, quandles, and braid monodromies; see Kamada [18]. In order to use them effectively for the study of compact Stein surfaces, we need to understand better interactions between Stein structures and braided surfaces.

In this paper, we consider whether or not, for a given positive braided surface S , there is more than one compact Stein surface realized as a cover of D^4 branched along S which have the same degrees and are mutually diffeomorphic, but which admit mutually distinct Stein structures. The following theorem is an affirmative answer to this problem.

Theorem 1.1 *For a given integer $N \geq 2$, there is a positive braided surface $S(N)$ and simple branched covers $X_1(N), \dots, X_N(N)$ of D^4 branched along $S(N)$ such that*

- (1) *the degrees of these covers are same,*
- (2) *$X_1(N), \dots, X_N(N)$ are mutually diffeomorphic, and*
- (3) *Stein structures on $X_1(N), \dots, X_N(N)$ associated to the covers are mutually not even homotopic as almost complex structures by any choice of diffeomorphism of the underlying spaces.*

We would like to emphasize that compact Stein surfaces $X_j(N)$ can be taken to be diffeomorphic to the D^2 –bundle over S^2 with Euler number $-2N$. We also note that in the above theorem, the Stein structure on the branched cover is given by a Lefschetz fibration associated to the branched covering; see Remark 2.4.

This theorem becomes more interesting when compared with the case of covers of $\mathbb{C}\mathbb{P}^2$ branched along cuspidal curves in $\mathbb{C}\mathbb{P}^2$. Here, a cuspidal curve is a projective plane curve whose singular points are ordinary nodes and ordinary cusps. The Chisini conjecture [7] claims that if $S \subset \mathbb{C}\mathbb{P}^2$ is a cuspidal curve, a *generic* branched covering of $\mathbb{C}\mathbb{P}^2$ whose branch set is S and degree is at least 5 is unique up to covering isomorphism. Kulikov [19; 20] showed that this conjecture is true under certain conditions. In the proof of Theorem 1.1, we will construct a simple branched covering of degree $3N - 1$ for each $N \geq 2$. In addition, according to a result of Rudolph [26], a positive braided surface is isotopic to the intersection of a complex analytic curve with $D^4 \subset \mathbb{C}^2$, and the converse is also true by a result of Boileau and Orevkov [6]. Hence

an analogue of the Chisini conjecture does not hold for simple branched coverings of D^4 whose branch sets are the intersections of complex analytic curves with D^4 .

Focusing on the boundary, we can reinterpret Theorem 1.1 in terms of contact 3-manifolds and transverse links. Let M be an oriented, connected, closed 3-manifold. A 2-plane field ξ on M is called a *contact structure* on M if there exists a 1-form on M such that $\xi = \text{Ker}(\alpha)$ and $\alpha \wedge d\alpha > 0$ with respect to the orientation of M ; the pair (M, ξ) is called a *contact manifold*. An oriented link L in (M, ξ) is called *transverse* if L is transverse to the contact plane ξ_x at any point x in L . Let (D^2, id) denote a *supporting open book decomposition* of the standard contact 3-sphere (S^3, ξ_{std}) whose pages are diffeomorphic to a 2-disk and whose monodromy is its identity map; see Etnyre [10] for example. Bennequin [5] showed that any transverse link in (S^3, ξ_{std}) can be braided about the binding of (D^2, id) .

Corollary 1.2 *For a given integer $N \geq 2$, there is a transverse link $L(N)$ in (S^3, ξ_{std}) and simple branched covers $M_1(N), \dots, M_N(N)$ of S^3 branched along $L(N)$ such that*

- (1) *the degrees of these covers are same,*
- (2) *$M_1(N), \dots, M_N(N)$ are mutually diffeomorphic, and*
- (3) *$M_1(N), \dots, M_N(N)$ equipped with contact structures associated to the covers are mutually not contactomorphic by any choice of diffeomorphism of the underlying spaces.*

Here, a contact structure on a branched cover is given by the open book associated to the branched covering.

This corollary turns out to be more interesting once we compare it with a work of Harvey, Kawamuro and Plamenevskaya [16]. They considered cyclic branched covers of (S^3, ξ_{std}) whose branch sets are transversely nonisotopic knots, which are smoothly isotopic, and proved that the covers are contactomorphic. On the other hand, in our result, we fix the transverse link as the branch set and the branched covers are not contactomorphic.

This article is organized as follows: In Section 2, we review some basic material such as mapping class groups, braided surfaces and Lefschetz fibrations. In Section 3.1, we first introduce the notion of braids satisfying a certain condition, called liftable braids, and prove a lemma to construct branched covers of D^4 . Using this lemma, we give a proof of Theorem 1.1. In Section 3.2, the theorem is proven again in a different way via transformations of Lefschetz fibrations. Finally, Section 3.3 is devoted to proving Corollary 1.2 using an invariant of contact structures.

2 Preliminaries

2.1 Mapping class groups

Let $\Sigma_{g,r}^k$ denote an oriented, connected genus g surface with k marked points and r boundary components. We denote the *mapping class group* of $\Sigma_{g,r}^k$ by $\mathcal{M}_{g,r}^k$. More precisely, $\mathcal{M}_{g,r}^k$ is the group of isotopy classes of orientation-preserving self-diffeomorphisms of $\Sigma_{g,r}^k$ which fix the marked points setwise and the boundary pointwise. We also use the notation $\mathcal{M}_{g,r}$ if $k = 0$, and $\mathcal{M}_{\Sigma_{g,r}^k}$ for $\mathcal{M}_{g,r}^k$. For a simple closed curve α in $\Sigma_{g,r}^k$, we denote by $t_\alpha \in \mathcal{M}_{g,r}^k$ the *right-handed Dehn twist* along α . Furthermore, for a simple arc a connecting two distinct marked points in $\Sigma_{g,r}^k$, write $\tau_a \in \mathcal{M}_{g,r}^k$ for the *right-handed half-twist* along a . We will use the opposite notation to the usual functional one for the products in $\mathcal{M}_{g,r}^k$; ie h_1h_2 means that we apply h_1 first and then h_2 . Moreover, for a subset $A \subset \Sigma_{g,r}^k$ and $h \in \mathcal{M}_{g,r}^k$, the notation $(A)h$ means the image of A under h .

It is well known that the braid group B_m on m strands can be identified with the mapping class group of a disk with m marked points as follows (see [12, Section 3.2]): Consider an m -marked disk $\Sigma_{0,1}^m$ as the closed unit disk $\mathbb{D}_m \subset \mathbb{C}$ with m marked points which lie on the real axis. Set $P_1 < \dots < P_m$ as the m marked points. Let A_i be a segment on the real axis connecting P_i and P_{i+1} . Then the i^{th} standard generator σ_i of B_m can be identified with the right-handed half-twist $\tau_{A_i} \in \mathcal{M}_{\mathbb{D}_m}$ along A_i .

2.2 Braided surfaces

Let D_1^2 and D_2^2 be oriented 2-disks.

Definition 2.1 A properly embedded surface S in $D_1^2 \times D_2^2$ is called a (simply) *braided surface* of degree m if the first projection $\text{pr}_1: D_1^2 \times D_2^2 \rightarrow D_1^2$ restricts to a simple branched covering $p_S := \text{pr}_1|_S: S \rightarrow D_1^2$ of degree m .

We will review briefly braid monodromies of braided surfaces; see [2, Section 3; 18, Chapters 16, 17; 27, Sections 1, 2] for more details. Before that, we recall a special basis for the fundamental group of a punctured disk. Let Δ be a set of n points x_1, \dots, x_n in the interior of an oriented 2-disk D^2 with the standard orientation and let x_0 be a point in ∂D^2 . Since the fundamental group $\pi_1(D^2 \setminus \Delta, x_0)$ is a free group of rank n , we give a basis for this group as follows: Take a collection of oriented paths s_1, \dots, s_n starting from x_0 to each x_i , respectively. Assume that s_i and s_j are disjoint except x_0 if $i \neq j$, and the arcs s_1, \dots, s_n are indexed so that they appear

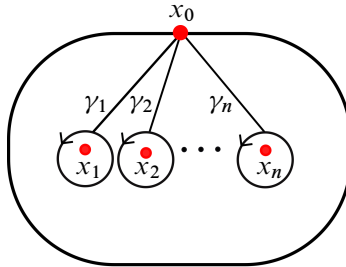

Figure 1: The standard Hurwitz system for (Δ, x_0)

in order as we move counterclockwise about x_0 . Using the path s_i , connect x_0 to a small oriented disk around each x_i with the same orientation of D^2 . Then we obtain an oriented loop γ_i based at x_0 , and $\gamma_1, \dots, \gamma_n$ freely generate $\pi_1(D^2 \setminus \Delta, x_0)$. The ordered n -tuple $(\gamma_1, \dots, \gamma_n)$ is called a *Hurwitz system* for (Δ, x_0) ; see Figure 1.

We now get back to braided surfaces. Let $\Delta(S) = \{x_1, \dots, x_n\} \subset \text{Int } D_1^2$ be the set of branch points of the branched covering $p_S: S \rightarrow D_1^2$. Fix a point $x_0 \in \partial D_1^2$ and Hurwitz system $(\gamma_1, \dots, \gamma_n)$ for $(\Delta(S), x_0)$. For each γ_i , the restriction on pr_1 to $\text{pr}_1^{-1}(\gamma_i)$ induces a trivial disk bundle over γ_i . For any point $x \in \gamma_i \subset D_1^2 \setminus \Delta(S)$, the preimage $p_S^{-1}(x)$ consists of m points; that is, S and each fiber $\text{pr}_1^{-1}(x) = D(x)$ intersect at m points. Hence we associate an element $b_i \in B_m$ to γ_i as a motion of the set $D(x_0) \cap S$ over γ_i . By this correspondence, we can define a homomorphism $\omega_S: \pi_1(D_1^2 \setminus \Delta(S), x_0) \rightarrow B_m$ by $\omega_S(\gamma_i) = b_i$ for each i . This homomorphism ω_S is called a *braid monodromy* of S . The ordered n -tuple $(\omega_S(\gamma_1), \dots, \omega_S(\gamma_n))$ is also called a braid monodromy of S . Since p_S is a simple branched covering, each $\omega_S(\gamma_i)$ is a conjugate $w_j^{-1} \sigma_{j(i)}^{\varepsilon_i} w_j$ of $j(i)^{\text{th}}$ standard generator of B_m or its inverse $\sigma_{j(i)}^{\varepsilon_i}$ for some $w_j \in B_m$ and $\varepsilon_i \in \{\pm 1\}$. It is known that, for a finite set $\Delta \subset \text{Int } D_1^2$ and homomorphism $\omega: \pi_1(D_1^2 \setminus \Delta, x_0) \rightarrow B_m$ as above, we can construct a braided surface of degree m whose branch set is Q and braid monodromy is ω . Obviously, the covering p_S has a *covering monodromy*, a representation $\rho_S: \pi_1(D_1^2 \setminus \Delta(S), x_0) \rightarrow \mathfrak{S}_m$ to the symmetric permutation group \mathfrak{S}_m of degree m . Note that each $\rho_S(\gamma_i) \in \mathfrak{S}_m$ is a transposition because p_S is simple. Furthermore, we also point out that ω_S is a lift of ρ_S to B_m .

At the end of this subsection, we define a crucial notion to study compact Stein surfaces by braided surfaces.

Definition 2.2 A braided surface S is said to be *positive* if each $\omega_S(\gamma_i)$ is positive; that is, every ε_i in a braid monodromy $(w_1^{-1} \sigma_{j(1)}^{\varepsilon_1} w_1, \dots, w_n^{-1} \sigma_{j(n)}^{\varepsilon_n} w_n)$ of S is $+1$.

2.3 Lefschetz fibrations and simple branched coverings

We will briefly review positive Lefschetz fibrations and their monodromies; see [15, Chapter 8].

Let X be an oriented, connected, compact 4–manifold.

A smooth map $f: X \rightarrow D^2$ is called a *positive Lefschetz fibration* if there exists the set $\Delta(f) = \{x_1, \dots, x_n\} \subset \text{Int}D^2$ such that

- (1) $f|_{f^{-1}(D^2 \setminus \Delta(f))}: f^{-1}(D^2 \setminus \Delta(f)) \rightarrow D^2 \setminus \Delta(f)$ is a smooth fiber bundle over $D^2 \setminus \Delta(f)$ with fiber diffeomorphic to an oriented compact surface Σ with boundary,
- (2) x_1, \dots, x_n are the critical values of f , and each *singular fiber* $f^{-1}(x_i)$ has a unique critical point $p_i \in f^{-1}(x_i)$, and
- (3) for each p_i and x_i , there are local complex coordinate charts with respect to the given orientations of X and D^2 such that locally f can be written as $f(z_1, z_2) = z_1^2 + z_2^2$.

A positive Lefschetz fibration $f: X \rightarrow D^2$ can be described by the mapping class group \mathcal{M}_Σ of a surface Σ diffeomorphic to the fiber of f . Let $x_0 \in \partial D^2$ be a fixed base point. Fix a Hurwitz system $(\gamma_1, \dots, \gamma_n)$ for $(\Delta(f), x_0)$. We can consider a homomorphism $\eta_f: \pi_1(D^2 \setminus \Delta(f), x_0) \rightarrow \mathcal{M}_\Sigma$ as follows: The positive Lefschetz fibration f restricts to a fiber bundle $f|_{f^{-1}(\gamma_i)}: f^{-1}(\gamma_i) \rightarrow \gamma_i$ for each γ_i . This bundle is isomorphic to a Σ –bundle whose monodromy is the Dehn twist t_{α_i} , where α_i is a simple closed curve in Σ . This α_i is called a *vanishing cycle* of the singular fiber $f^{-1}(x_i)$. Let us define $\eta_f: \pi_1(D^2 \setminus \Delta(f), x_0) \rightarrow \mathcal{M}_\Sigma$, called a *monodromy* of f , by $\eta_f(\gamma_i) = t_{\alpha_i}$ for each γ_i . We also call the ordered n –tuple $(t_{\alpha_1}, \dots, t_{\alpha_n})$ a monodromy of f . A positive Lefschetz fibration is said to be *allowable* if all of its vanishing cycles are homologically nontrivial in the fiber surface. After this, we call a positive allowable Lefschetz fibration a PALF for short.

Theorem 2.3 (Loi and Piergallini [21, Theorem 3]) *Let X be an oriented, connected, compact 4–manifold with boundary. Then the following conditions are equivalent:*

- (1) X is a compact Stein surface; that is, X admits a Stein structure.
- (2) X admits a PALF $f: X \rightarrow D^2$.
- (3) X is a simple branched cover of D^4 branched along a positive braided surface.

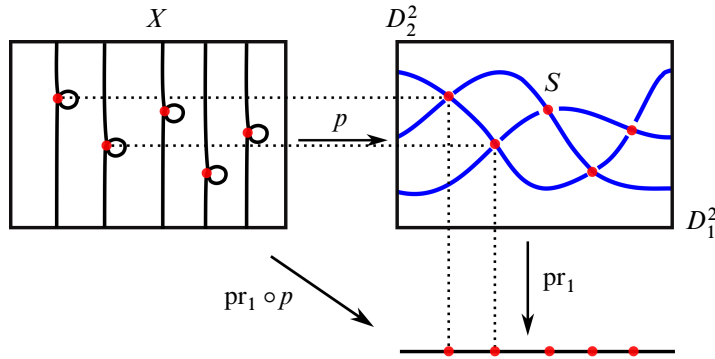

Figure 2: The left (resp. right) square represents the total space X of p (resp. $D_1^2 \times D_2^2$). The red points in X (resp. $D_1^2 \times D_2^2$) represents the critical points of the PALF $\text{pr}_1 \circ p$ (resp. the branched covering p_S).

We would like to point out that Akbulut and Ozbagci [1, Theorem 5] also showed the equivalence between (1) and (2) in the above theorem.

According to [21, Proposition 1, 2] and the proof of Theorem 2.3, for a given PALF $f: X \rightarrow D^2$, we can construct a simple branched covering $p: X \rightarrow D^4$ whose branch set is a positive braided surface S so that $f = \text{pr}_1 \circ p$ and $\Delta(S) = \Delta(f)$. Conversely, for a given simple branched covering $p: X \rightarrow D^4$ whose branch set is a positive braided surface S , the composition $f := \text{pr}_1 \circ p: X \rightarrow D_1^2$ is a PALF and $\Delta(f) = \Delta(S)$; see Figure 2. Suppose that $x \in D_1^2$ is a regular point of the PALF $f = \text{pr}_1 \circ p$. It is also a regular point of p_S . Since p is a simple branched covering branched along S , the covering p restricts to a simple branched covering $p|_{p^{-1}(D(x))}: p^{-1}(D(x)) \rightarrow D(x)$ whose branch set is the intersection $S \cap D(x)$. It is easy to check that $p^{-1}(D(x))$ is the regular fiber $f^{-1}(x)$ of f .

Remark 2.4 It is known that the total space of a PALF admits a Stein structure by using the (Weinstein) handle decomposition given by the PALF; see [1, Theorem 5]. As mentioned above, a simple branched covering $p: X \rightarrow D^4 \cong D_1^2 \times D_2^2$ branched along a positive braided surface gives a PALF $\text{pr}_1 \circ p: X \rightarrow D_1^2$. Thus, we equip the cover X with a Stein structure coming from $\text{pr}_1 \circ p$.

2.4 First Chern classes of compact Stein surfaces

In the proof of Theorem 1.1, we use the first Chern class of a compact Stein surface. To compute it, we make use of the following facts in [11, Section 3] and

[14, Proposition 2.3]. Let $f: X \rightarrow D^2$ denote a PALF with fiber diffeomorphic to Σ and let $\alpha_1, \dots, \alpha_n$ be its vanishing cycles. Thanks to Theorem 2.3, X admits a Stein structure J . Once we choose a trivialization of the tangent bundle of the regular fiber of f , the rotation number $\text{rot}(\alpha)$ of a simple closed curve α is defined with respect to this trivialization. Orient each vanishing cycle α_i and regard it as a generator of the chain group $C_2(X)$; see [15, Section 4.2]. Then we have

$$\langle c_1(X, J), [\alpha_i] \rangle = \text{rot}(\alpha_i)$$

for the first Chern class $c_1(X, J)$ of (X, J) .

Next we review how to compute the square of the Poincaré dual $\text{PD}(c_1(X, J))$ of the class $c_1(X, J)$ to use it in the proof of Corollary 1.2; see [25, pages 107–108] for more details. For our purpose, it suffices to see a compact Stein surface X admitting a handle decomposition with only one 0–handle and one 2–handle h . Let K be the attaching circle of h with framing coefficient k and D a small meridian disk to K . The homology group $H_2(X; \mathbb{Z})$ is generated by the closed surface Σ given by gluing an orientable Seifert surface for K and the core of the 2–handle h , and $H_2(X, \partial X; \mathbb{Z})$ is generated by $[D]$. The maps $\varphi_1: H_2(X; \mathbb{Z}) \rightarrow H_2(X, \partial X; \mathbb{Z})$ and $\varphi_2: H_2(X, \partial X; \mathbb{Z}) \rightarrow H_1(\partial X; \mathbb{Z})$ in the homology long exact sequence for $(X, \partial X)$ are given by

$$\varphi_1([\Sigma]) = k[D] \quad \text{and} \quad \varphi_2([D]) = [\partial D].$$

Suppose that the first Chern class $c_1(\xi)$ of the contact structure ξ on ∂X induced from J is a torsion class. Then $\varphi_2(\text{PD}(c_1(X, J))) = \text{PD}(c_1(\xi))$ is a torsion class too, and hence there exists an integer $n > 0$ such that $\varphi_2(n \cdot \text{PD}(c_1(X, J))) = 0$, which implies that we obtain a lift $c \in H_2(X; \mathbb{Z})$ of $\text{PD}(n \cdot c_1(X, J))$ with respect to φ_1 . Using the element c , the square of $\text{PD}(c_1(X, J))$ is given by

$$(\text{PD}(c_1(X, J)))^2 = \frac{1}{n^2} c^2.$$

It is obvious that this value is independent of the choice of $n > 0$.

3 Main results

3.1 Proof of Theorem 1.1

Let Σ be an oriented, compact surface with boundary. Suppose $q: \Sigma \rightarrow D^2$ is a simple branched covering of degree d . The covering q determines a covering monodromy $\rho_q: \pi_1(D^2 \setminus \Delta(q), y_0) \rightarrow \mathfrak{S}_d$ for some base point $y_0 \in \partial D^2$. Identifying B_m

with $\mathcal{M}_{0,1}^m$ as in Section 2.1, we associate to a given $b \in B_m$ the mapping class $h_b \in \mathcal{M}_{0,1}^m$. We call $b \in B_m$ or $h_b \in \mathcal{M}_{0,1}^m$ *liftable* with respect to the branched covering $q: \Sigma \rightarrow D^2$ with m branch points if there exists an orientation-preserving diffeomorphism H_b of Σ such that $q \circ H_b = h \circ q$ for some representative h of h_b . Note that, in this definition, the base disk D^2 with m branch points is identified with \mathbb{D}_m and we consider $\mathcal{M}_{0,1}^m$ as the mapping class group of \mathbb{D}_m . Hereafter, we fix such an identification unless otherwise specified. In [22, Lemma 4.3.3], it is shown that, if $h_b \in \mathcal{M}_{0,1}^m$ is liftable with respect to q , then we have

$$(1) \quad \rho_q \circ h_{b*} = \rho_q$$

for the induced isomorphism $h_{b*}: \pi_1(D^2 \setminus \Delta(q), y_0) \rightarrow \pi_1(D^2 \setminus \Delta(q), y_0)$.

The following lemma is useful for constructing simple branched covers of D^4 .

Lemma 3.1 *Let S be a positive braided surface of degree m whose braid monodromy is*

$$(w_1^{-1}\sigma_{j(1)}w_1, \dots, w_n^{-1}\sigma_{j(n)}w_n),$$

and x_0 a fixed base point in ∂D_1^2 . Suppose that $q: \Sigma \rightarrow D(x_0)$ is a simple branched covering of degree d with branch set $S \cap D(x_0)$ and covering monodromy ρ_q . If each $w_i^{-1}\sigma_{j(i)}w_i \in B_m$ is liftable with respect to q , then there is an oriented, connected, compact 4-manifold X and a simple branched covering $p: X \rightarrow D^4$ such that its branch set is S and $p|_{p^{-1}(D(x_0))} = q$.

Proof Fix a point $y_0 \in \partial D(x_0)$. Let $(\gamma'_1, \dots, \gamma'_m)$ be the standard Hurwitz system for $(D(x_0) \setminus S, y_0)$ as in Figure 1. It is known that

$$\pi_1(D^4 \setminus S, y_0) = \langle \gamma'_1, \dots, \gamma'_m \mid (\gamma'_{j(i)})w_{i*} = (\gamma'_{j(i)+1})w_{i*}, i = 1, \dots, n \rangle,$$

where each w_{i*} is the Artin automorphism of the free group $\langle \gamma'_1, \dots, \gamma'_m \rangle$ defined by

$$(\gamma'_j)\sigma_{i*} = \begin{cases} \gamma'_i\gamma'_{i+1}\gamma'^{-1}_i, & j = i, \\ \gamma'_i, & j = i + 1, \\ \gamma'_j, & j \neq i, i + 1. \end{cases}$$

More precisely, we refer to [13, page 133; 27, Proposition 4.1; 17, pages 120–121] about this fundamental group. If we show that $\rho_q((\gamma'_{j(i)})w_{i*}) = \rho_q((\gamma'_{j(i)+1})w_{i*})$ for each i , we conclude that ρ_q induces a homomorphism $\rho: \pi_1(D^4 \setminus S, y_0) \rightarrow \mathfrak{S}_d$, and this ρ determines a simple branched covering $p: X \rightarrow D^4$ of degree d whose branch set is S .

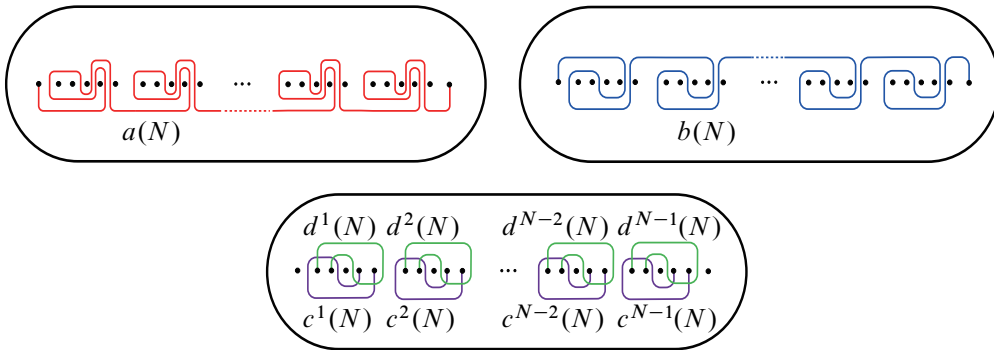

Figure 3: Arcs $a(N)$, $b(N)$, $c^i(N)$, $d^i(N)$

For each i , we have

$$\begin{aligned} (\gamma'_{j(i)})w_{i*} &= ((\gamma'_{j(i)+1})\sigma_{j(i)*})w_{i*} \\ &= (\gamma'_{j(i)+1})(w_{i*}(w_i)_*^{-1})\sigma_{j(i)*}w_{i*} \\ &= ((\gamma'_{j(i)+1})w_{i*})(w_i^{-1}\sigma_{j(i)}w_i)_*. \end{aligned}$$

Since each $w_i^{-1}\sigma_{j(i)}w_i$ is liftable, by (1),

$$\begin{aligned} \rho_q((\gamma'_{j(i)})w_{i*}) &= \rho_q(((\gamma'_{j(i)+1})w_{i*})(w_i^{-1}\sigma_{j(i)}w_i)_*) \\ &= (\rho_q \circ (w_i^{-1}\sigma_{j(i)}w_i)_*)((\gamma'_{j(i)+1})w_{i*}) \\ &= \rho_q((\gamma'_{j(i)+1})w_{i*}). \end{aligned}$$

According to the above construction of p , we can easily check $p|p^{-1}(D(x_0)) = q$. \square

Proof of Theorem 1.1 Fix x_0 in ∂D_1^2 and y_0 in $\partial D(x_0)$. To construct a braided surface, we give arcs $a(N)$, $b(N)$, $c^i(N)$, $d^i(N)$ for $i = 1, 2, \dots, N - 1$ in a $(5N - 3)$ -marked disk as depicted in Figure 3. Let us define a braided surface $S(N)$ of degree $5N - 3$ to be one whose braid monodromy is

$$(2) \quad (\tau_{a(N)}, \tau_{b(N)}, \tau_{c^1(N)}, \dots, \tau_{c^{N-1}(N)}, \tau_{d^1(N)}, \dots, \tau_{d^{N-1}(N)}).$$

To apply Lemma 3.1, we need appropriate simple branched covers of $D(x_0)$. Define a simple branched covering $q_j(N): \Sigma_{0,2N} \rightarrow D(x_0)$ of degree $3N - 1$ for each $j = 1, \dots, N$ as shown in Figure 4. According to [22, Lemma 3.2.3] for example, we can check that each braid of the tuple (2) is liftable with respect to each covering $q_j(N)$; see Figure 5. It follows from Lemma 3.1 that there exists a simple branched

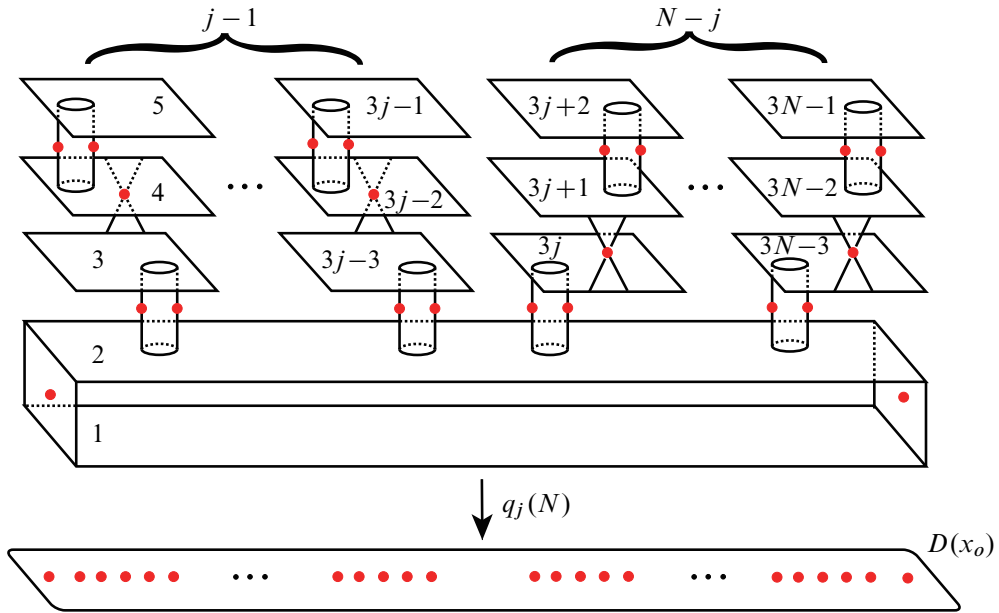

Figure 4: Covering $q_j(N): \Sigma_{0,2N} \rightarrow D(x_0)$: each label indicates the index of each sheet of the covering.

covering $p_j(N): X_j(N) \rightarrow D^4$ branched along $S(N)$ such that for each j ,

$$p_j(N)|(p_j(N)^{-1}(D(x_0))) = q_j(N).$$

Next, we show that $X_1(N), \dots, X_N(N)$ are mutually diffeomorphic. To see this, we will draw a Kirby diagram of $X_j(N)$ via Lefschetz fibration. As discussed in Section 2.3, the composition $\text{pr}_1 \circ p_j(N): X_j(N) \rightarrow D_1^2$ is a PALF whose monodromy is the lift of the braid monodromy (2) of $S(N)$ with respect to $q_j(N)$. Write

$$(t_{A_j(N)}, t_{B_j(N)}, t_{C_j^1(N)}, \dots, t_{C_j^{N-1}(N)}, t_{D_j^1(N)}, \dots, t_{D_j^{N-1}(N)})$$

for this monodromy, where the simple closed curves $A_j(N), B_j(N), C_j^i(N), D_j^i(N)$ are the lift of the arcs $a(N), b(N), c^i(N), d^i(N)$, respectively, with respect to $q_j(N)$. An isotopy of the surface $\Sigma_{0,2N}$ makes a configuration of vanishing cycles as shown in Figure 6. This leads to a Kirby diagram of $X_j(N)$ depicted in Figure 7 (top). Let $A_j(N), B_j(N), C_j^i(N), D_j^i(N)$ also denote the 2–handles whose attaching spheres are these curves, respectively. Sliding the 2–handle $A_j(N)$ over $C_j^i(N)$ and $D_j^i(N)$ and canceling the 1–/2–handle pairs related to $C_j^i(N)$ and $D_j^i(N)$, we obtain the

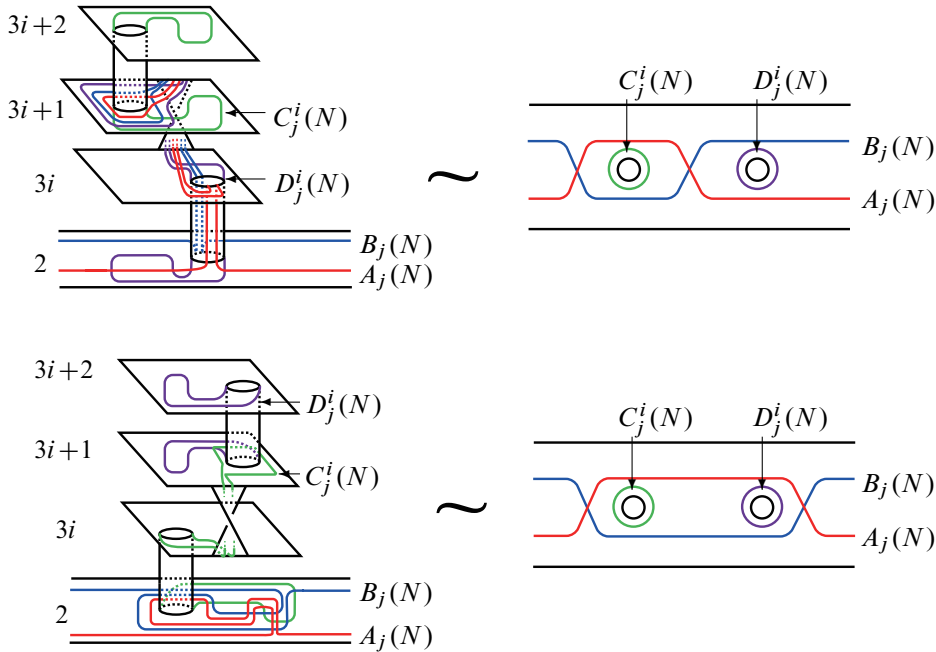

Figure 5: Parts of lifts of arcs $a(N)$, $b(N)$, $c^i(N)$, $d^i(N)$ with respect to $q_j(N)$. Top: sheets labeled $2, 3i, 3i + 1, 3i + 2$ for $i = 1, \dots, j - 1$. Bottom: sheets labeled $2, 3i, 3i + 1, 3i + 2$ for $i = j, \dots, N - 1$.

diagram depicted in Figure 7 (bottom left). We reach the one depicted in Figure 7 (bottom right) by sliding the $(-2N + 1)$ -framed 2-handle over the other and eliminating the remaining $1/-2$ -handle pair. From the last diagram, we conclude that all $X_j(N)$ are diffeomorphic to the D^2 -bundle over S^2 with Euler number $-2N$.

To finish the proof, we compute the first Chern class of each $(X_j(N), J_j(N))$, where $J_j(N)$ is the Stein structure associated to $p_j(N)$. Strictly speaking, $c_1(X_j(N), J_j(N))$ can evaluate on the generator of $H_2(X_j(N); \mathbb{Z})$. According to the above argument about Kirby diagrams, it turns out that its generator is given by

$$(3) \quad Z_j(N) := [A_j(N)] - [B_j(N)] - \sum_{i=1}^{N-1} [C_j^i(N)] + \sum_{i=1}^{j-1} [D_j^i(N)] - \sum_{i=j}^{N-1} [D_j^i(N)].$$

Here all 2-handles are oriented as indicated in Figure 7 (top). One can take a trivialization of the bundle $T\Sigma_{0,2N}$ so that the rotation number of each vanishing cycle is $+1$.

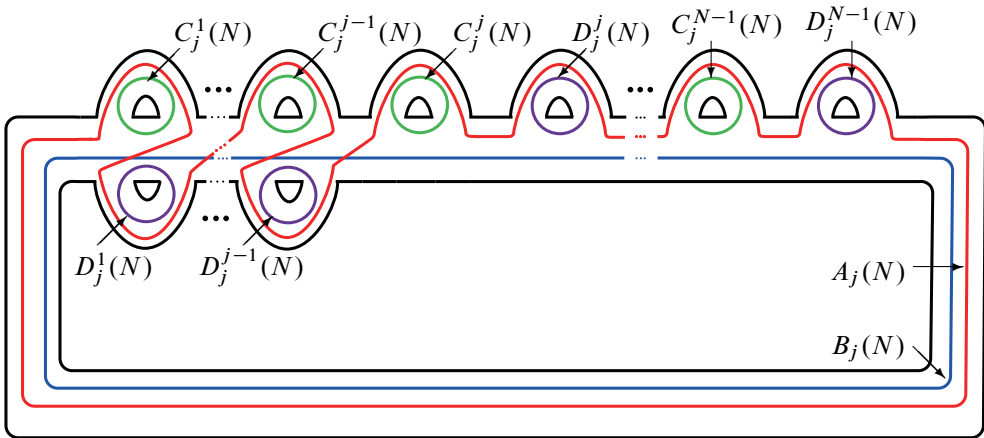
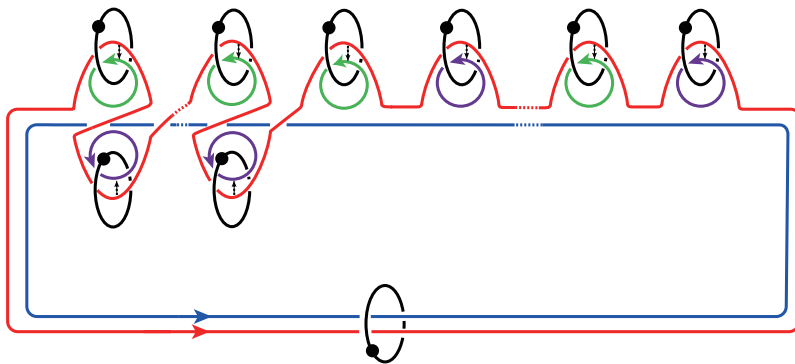

Figure 6: Vanishing cycles of the PALF $pr_1 \circ p_j(N): X_j(N) \rightarrow D_1^2$



all 2-handle framings -1

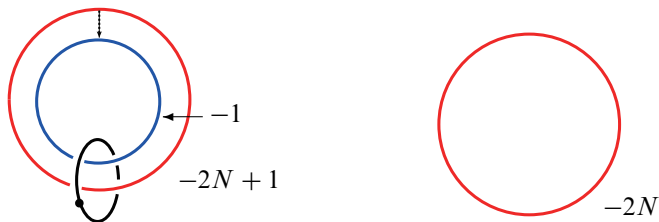

Figure 7: Kirby diagrams of $X_j(N)$: the dashed arrows indicate how we slide a 2-handle over another one.

Hence, we have

$$\begin{aligned}
 \langle c_1(X_j(N), J_j(N)), Z_j(N) \rangle &= \text{rot}(A_j(N)) - \text{rot}(B_j(N)) - \sum_{i=1}^{N-1} \text{rot}(C_j^i(N)) \\
 &\quad + \sum_{i=1}^{j-1} \text{rot}(D_j^i(N)) - \sum_{i=j}^{N-1} \text{rot}(D_j^i(N)) \\
 &= (+1) - (+1) - \sum_{i=1}^{N-1} (+1) + \sum_{i=1}^{j-1} (+1) - \sum_{i=j}^{N-1} (+1) \\
 &= -2(N - j).
 \end{aligned}$$

Since this value is unchanged under any diffeomorphism of $X_j(N)$, we conclude that $c_1(X_j(N), J_j(N)) \neq c_1(X_{j'}(N), J_{j'}(N))$ if $j \neq j'$. Therefore, Stein structures $J_1(N), \dots, J_N(N)$ are mutually not even homotopic as almost complex structures. \square

Remark 3.2 In the above proof, the case $N = 2$ is crucial, so we explain how the author found the braided surface $S(2)$. First, we fixed two different branched coverings $q_1(2)$ and $q_2(2)$ and considered liftable braids with respect to both coverings. We observed how corresponding lifts changed if we changed $q_1(2)$ into $q_2(2)$, and we chose some braids among them to obtain the braided surface $S(2)$. Finally, drawing Kirby diagrams of the two corresponding covers branched along $S(2)$, we checked whether these covers satisfied the conditions of our theorem. Hence, this construction is very ad hoc. As far as the author knows, there is no systematic construction of such a braided surface.

3.2 Alternative proof of Theorem 1.1

The key of the second proof is a T -move, introduced by Apostolakis, Piergallini and Zuddas in [2]. This move is a transformation between two Lefschetz fibrations, satisfying some conditions. For our purpose, here we will deal with specific T -moves; see [2, Section 7] for more general cases.

Let $f: X \rightarrow D^2$ (resp. $f': X' \rightarrow D^2$) be a PALF whose fibers are diffeomorphic to a surface Σ (resp. Σ'), and the collection of vanishing cycles are $\{\alpha_1, \dots, \alpha_n\}$ (resp. $\{\alpha'_1, \dots, \alpha'_n\}$). Suppose that two surfaces Σ and Σ' satisfy the following: First, there are subsurfaces $F \subset \Sigma$ and $F' \subset \Sigma'$ each of which is decomposed into a 1-handle h (resp. h') and an annulus whose boundary meets $\partial\Sigma$ (resp. $\partial\Sigma'$) along the four arcs indicated in Figure 8, left (resp. right). Next, Σ and Σ' are diffeomorphic, and $\Sigma \setminus F$ and $\Sigma' \setminus F'$ coincide. Finally, F (resp. F') contains α_i, α_{i+1} (resp. α'_i, α'_{i+1}), and the other vanishing cycles of f and f' lie outside the 1-handles h and h' and mutually coincide. Then the transformation $T: f \leftrightarrow f'$ is called a T -move. Using Kirby

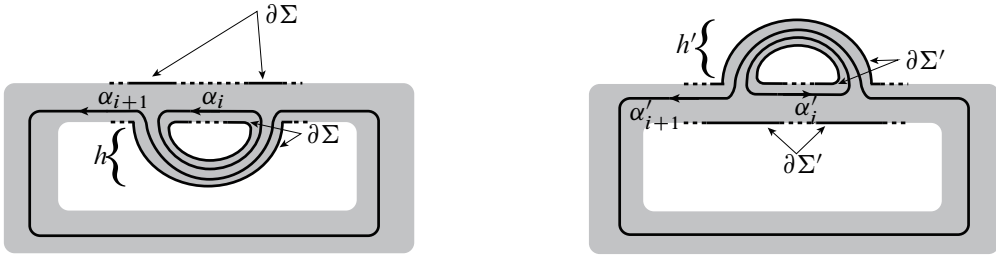

Figure 8

diagrams, one can check that any T -move preserves the diffeomorphism type of the total space of a PALF.

The following proposition helps us to detect the difference between Stein structures.

Proposition 3.3 (see [2, Proposition 13]) *Let $f, f': X \rightarrow D^2$ be PALFs related by a single T -move as in Figure 8. Write J and J' for Stein structures on X associated to f and f' , respectively. Suppose that vanishing cycles α_i, α_{i+1} and α'_i, α'_{i+1} are oriented as in Figure 8. Then $c_1(X, J') - c_1(X, J) = -2[\alpha_i^*]$, where $\alpha_i^* \in C^2(X)$ is the dual element of $\alpha_i \in C_2(X)$.*

Proof of Theorem 1.1 We will show via T -moves that the coverings defined in the previous proof, namely $p_j(N): X_j(N) \rightarrow D^4$, are the desired ones. We use here the same notation in the previous section.

Set $g_j(N) = \text{pr}_1 \circ p_j(N): X_j(N) \rightarrow D^2_1$. Comparing Figure 6 with Figure 8, two PALFs $g_j(N)$ and $g_{j+1}(N)$ are related by a single T -move. Hence so are any two $g_j(N)$ and $g_{j'}(N)$ by a sequence of T -moves, and $X_j(N)$ and $X_{j'}(N)$ are mutually diffeomorphic.

To see the distinction of Stein structures associated the coverings $p_j(N)$, we show that

$$c_1(X_j(N), J_j(N)) - c_1(X_{j'}(N), J_{j'}(N)) \neq 0$$

for any $j, j' \in \{1, \dots, N\}$ with $j < j'$. It follows from Proposition 3.3 that

$$\begin{aligned} c_1(X_j(N), J_j(N)) - c_1(X_{j'}(N), J_{j'}(N)) &= \sum_{i=j}^{j'-1} (c_1(X_i(N), J_i(N)) - c_1(X_{i+1}(N), J_{i+1}(N))) \\ &= \sum_{i=j}^{j'-1} (-2[D_{i+1}^i(N)^*]) = \sum_{i=j}^{j'-1} (-2[D_{j'}^i(N)^*]). \end{aligned}$$

The last equality follows from the canonical identification of $D_j^{j-1}(N)$ with $D_{j+1}^{j-1}(N)$. Thus we conclude that

$$\langle c_1(X_j(N), J_j(N)) - c_1(X_{j'}(N), J_{j'}(N)), Z_{j'}(N) \rangle = -2(j' - j),$$

where $Z_{j'}(N)$ is a generator of $H_2(X_{j'}(N); \mathbb{Z})$ defined by (3) in Section 3.1. This implies that two Stein structures mutually are not homotopic. □

The proof tells us that $g_{j+1}(N)$ is obtained from $g_j(N)$ by a single T -move, which raises the following question.

Question 3.4 *Let $f_j: X \rightarrow D^2$ ($j = 1, 2$) be PALFs related by a single T -move. Is there a braided surface S and branched coverings $p_j: X \rightarrow D^4$ of the same degree whose branch sets coincide with S and which satisfy $f_j = \text{pr}_1 \circ p_j$?*

3.3 Proof of Corollary 1.2

The boundary of a braided surface S is contained in $\partial D_1^2 \times D_2^2$, and it is the closure of a braid. Letting U be the core of $D_1^2 \times \partial D_2^2$, we obtain from the product structure on $\partial D_1^2 \times D_2^2$, an open book decomposition of $S^3 \cong \partial D^4 \cong \partial(D_1^2 \times D_2^2)$ whose page is a disk and binding is U . This open book supports the standard contact structure ξ_{std} on S^3 . Thus, we can regard ∂S as a transverse link in (S^3, ξ_{std}) by a result of Bennequin [5].

To distinguish contact structures, we introduce an invariant of them, following [15, Section 11.3]. Let (M, ξ) be a contact 3-manifold with Stein filling (X, J) . Suppose that $c_1(\xi)$ is a torsion class. For such (M, ξ) , define $\theta(\xi)$ to be

$$(\text{PD}(c_1(X, J)))^2 - 2\chi(X) - 3\sigma(X),$$

where $\chi(X)$ and $\sigma(X)$ are the Euler characteristic and the signature of X , respectively. Note that $\theta(\xi)$ depends only on (M, ξ) ; see [15, Theorem 11.3.4].

Proof of Corollary 1.2 Let $L(N)$ be the boundary of $S(N)$ in the proof of Theorem 1.1. By the previous argument, $L(N)$ can be seen as a transverse link in (S^3, ξ_{std}) . Let $M_j(N) = \partial X_j(N)$. Then 3-manifolds $M_1(N), \dots, M_N(N)$ are mutually diffeomorphic to $L(2N, 1)$. The covering $p_j(N): X_j(N) \rightarrow D^4$ restricts to the simple branched covering of S^3 branched along $L(N)$ on the boundary $M_j(N)$. Set

$$\psi_j(N) = t_{A_j(N)} t_{B_j(N)} t_{C_j^1(N)} \cdots t_{C_j^{N-1}(N)} t_{D_j^1(N)} \cdots t_{D_j^{N-1}(N)} \in \mathcal{M}_{0,2N}.$$

Through the PALF $pr_1 \circ p_j(N)$, the cover $M_j(N)$ admits the open book whose page is diffeomorphic to $\Sigma_{0,2N}$ and monodromy is $\psi_j(N)$. The Stein surface $(X_j(N), J_j(N))$ serves as a Stein filling of the contact manifold $(M_j(N), \xi_j(N))$ compatible with the open book $(\Sigma_{0,2N}, \psi_j(N))$.

Now, we compute the invariant $\theta(\xi_j(N))$. Since

$$H^2(M_j(N); \mathbb{Z}) \cong H^2(L(2N, 1); \mathbb{Z}) \cong \mathbb{Z}_{2N},$$

the Chern class $c_1(\xi_j(N))$ is a torsion class, and in particular, $2N \cdot c_1(\xi_j(N)) = 0$. From the proof of Theorem 1.1 in Section 3.1, it follows that $PD(c_1(X_j(N), J_j(N))) = -2(N - j)[D(N)]$, where $D(N)$ is a small meridian disk to the unknot depicted in Figure 7 (bottom right). Hence, the class $PD(2N \cdot c_1(X_j(N), J_j(N)))$ lifts to $2(N - j)Z_j(N)$ with respect to the map $H_2(X_j(N); \mathbb{Z}) \rightarrow H_2(X_j(N), \partial X_j(N); \mathbb{Z})$, which shows that

$$(PD(c_1(X_j(N), J_j(N))))^2 = \frac{1}{(2N)^2} (2(N - j))^2 Z_j(N)^2 = -\frac{2(N - j)^2}{N}.$$

Therefore,

$$\theta(\xi_j(N)) = -\frac{2(N - j)^2}{N} - 2 \cdot 2 - 3 \cdot (-1)$$

for $(M_j(N), \xi_j(N))$ and $(X_j(N), J_j(N))$. The invariants $\theta(\xi_j(N))$ for $j = 1, \dots, N$ are mutually different values, and hence the contact manifolds $(M_j(N), \xi_j(N))$ are mutually not contactomorphic, which completes the proof. \square

Acknowledgements The author would like to express his gratitude to Professor Hisaaki Endo for his encouragement and helpful comments for the draft of this article. He would also like to thank Burak Ozbagci for his helpful comments and fruitful discussions and the anonymous referees for suggesting many improvements. This work was partially supported by JSPS KAKENHI Grant Number 15J05214.

References

- [1] **S Akbulut, B Ozbagci**, *Lefschetz fibrations on compact Stein surfaces*, *Geom. Topol.* 5 (2001) 319–334 MR
- [2] **N Apostolakis, R Piergallini, D Zuddas**, *Lefschetz fibrations over the disc*, *Proc. Lond. Math. Soc.* 107 (2013) 340–390 MR
- [3] **R İ Baykur, J Van Horn-Morris**, *Families of contact 3-manifolds with arbitrarily large Stein fillings*, *J. Differential Geom.* 101 (2015) 423–465 MR

- [4] **R İ Baykur, J Van Horn-Morris**, *Topological complexity of symplectic 4-manifolds and Stein fillings*, J. Symplectic Geom. 14 (2016) 171–202 MR
- [5] **D Bennequin**, *Entrelacements et équations de Pfaff*, from “Third Schnepfenried geometry conference, I” (D Bernard, G Reeb, editors), Astérisque 107, Soc. Math. France, Paris (1983) 87–161 MR
- [6] **M Boileau, S Orevkov**, *Quasi-positivité d’une courbe analytique dans une boule pseudo-convexe*, C. R. Acad. Sci. Paris Sér. I Math. 332 (2001) 825–830 MR
- [7] **O Chisini**, *Sulla identità birazionale delle funzioni algebriche di due variabili dotate di una medesima curva di diramazione*, Ist. Lombardo Sci. Lett. Cl. Sci. Mat. Nat. Rend. 8 (1944) 339–356 MR
- [8] **E Dalyan, M Korkmaz, M Pamuk**, *Arbitrarily long factorizations in mapping class groups*, Int. Math. Res. Not. 2015 (2015) 9400–9414 MR
- [9] **Y Eliashberg**, *Topological characterization of Stein manifolds of dimension > 2* , Internat. J. Math. 1 (1990) 29–46 MR
- [10] **J B Etnyre**, *Lectures on open book decompositions and contact structures*, from “Floer homology, gauge theory, and low-dimensional topology” (D A Ellwood, P S Ozsváth, A I Stipsicz, Z Szabó, editors), Clay Math. Proc. 5, Amer. Math. Soc., Providence, RI (2006) 103–141 MR
- [11] **J B Etnyre, B Ozbagci**, *Invariants of contact structures from open books*, Trans. Amer. Math. Soc. 360 (2008) 3133–3151 MR
- [12] **J B Etnyre, J Van Horn-Morris**, *Monoids in the mapping class group*, from “Interactions between low-dimensional topology and mapping class groups” (R İ Baykur, J Etnyre, U Hamenstädt, editors), Geom. Topol. Monogr. 19, Geom. Topol. Publ., Coventry (2015) 319–365 MR
- [13] **R H Fox**, *A quick trip through knot theory*, from “Topology of 3-manifolds and related topics” (M K Fort, Jr, editor), Prentice-Hall, Englewood Cliffs, N.J. (1962) 120–167 MR
- [14] **R E Gompf**, *Handlebody construction of Stein surfaces*, Ann. of Math. 148 (1998) 619–693 MR
- [15] **R E Gompf, A I Stipsicz**, *4-manifolds and Kirby calculus*, Graduate Studies in Mathematics 20, Amer. Math. Soc., Providence, RI (1999) MR
- [16] **S Harvey, K Kawamuro, O Plamenevskaya**, *On transverse knots and branched covers*, Int. Math. Res. Not. 2009 (2009) 512–546 MR
- [17] **S Kamada**, *A characterization of groups of closed orientable surfaces in 4-space*, Topology 33 (1994) 113–122 MR
- [18] **S Kamada**, *Braid and knot theory in dimension four*, Mathematical Surveys and Monographs 95, Amer. Math. Soc., Providence, RI (2002) MR

- [19] **V S Kulikov**, *On Chisini's conjecture*, *Izv. Ross. Akad. Nauk Ser. Mat.* 63 (1999) 83–116 MR In Russian; translated in *Izv. Math.* 63 (1999) 1139–1170
- [20] **V S Kulikov**, *On Chisini's conjecture, II*, *Izv. Ross. Akad. Nauk Ser. Mat.* 72 (2008) 63–76 MR In Russian; translated in *Izv. Math.* 72 (2008) 901–913
- [21] **A Loi, R Piergallini**, *Compact Stein surfaces with boundary as branched covers of B^4* , *Invent. Math.* 143 (2001) 325–348 MR
- [22] **J M Montesinos-Amilibia, H R Morton**, *Fibred links from closed braids*, *Proc. London Math. Soc.* 62 (1991) 167–201 MR
- [23] **B Ozbagci**, *On the topology of fillings of contact 3-manifolds*, from “Interactions between low-dimensional topology and mapping class groups” (R İ Baykur, J Etnyre, U Hamenstädt, editors), *Geom. Topol. Monogr.* 19, *Geom. Topol. Publ.*, Coventry (2015) 73–123 MR
- [24] **B Ozbagci, A I Stipsicz**, *Contact 3-manifolds with infinitely many Stein fillings*, *Proc. Amer. Math. Soc.* 132 (2004) 1549–1558 MR
- [25] **B Ozbagci, A I Stipsicz**, *Surgery on contact 3-manifolds and Stein surfaces*, *Bolyai Society Mathematical Studies* 13, Springer (2004) MR
- [26] **L Rudolph**, *Algebraic functions and closed braids*, *Topology* 22 (1983) 191–202 MR
- [27] **L Rudolph**, *Braided surfaces and Seifert ribbons for closed braids*, *Comment. Math. Helv.* 58 (1983) 1–37 MR

Department of Mathematics, Tokyo Institute of Technology
Tokyo, Japan

oba.t.ac@m.titech.ac.jp

Received: 18 April 2017 Revised: 20 July 2017

