

Algebra & Number Theory

Volume 12
2018
No. 5

Characterization of Kollár surfaces

Giancarlo Urzúa and José Ignacio Yáñez



Characterization of Kollár surfaces

Giancarlo Urzúa and José Ignacio Yáñez

Kollár (2008) introduced the surfaces

$$(x_1^{a_1} x_2 + x_2^{a_2} x_3 + x_3^{a_3} x_4 + x_4^{a_4} x_1 = 0) \subset \mathbb{P}(w_1, w_2, w_3, w_4)$$

where $w_i = W_i/w^*$, $W_i = a_{i+1}a_{i+2}a_{i+3} - a_{i+2}a_{i+3} + a_{i+3} - 1$, and $w^* = \gcd(W_1, \dots, W_4)$. The aim was to give many interesting examples of \mathbb{Q} -homology projective planes. They occur when $w^* = 1$. For that case, we prove that Kollár surfaces are Hwang–Keum (2012) surfaces. For $w^* > 1$, we construct a geometrically explicit birational map between Kollár surfaces and cyclic covers $z^{w^*} = l_1^{a_2 a_3 a_4} l_2^{-a_3 a_4} l_3^{a_4} l_4^{-1}$, where $\{l_1, l_2, l_3, l_4\}$ are four general lines in \mathbb{P}^2 . In addition, by using various properties on classical Dedekind sums, we prove that:

- For any $w^* > 1$, we have $p_g = 0$ if and only if the Kollár surface is rational. This happens when $a_{i+1} \equiv 1$ or $a_i a_{i+1} \equiv -1 \pmod{w^*}$ for some i .
- For any $w^* > 1$, we have $p_g = 1$ if and only if the Kollár surface is birational to a K3 surface. We classify this situation.
- For $w^* \gg 0$, we have that the smooth minimal model S of a generic Kollár surface is of general type with $K_S^2/e(S) \rightarrow 1$.

1. Introduction	1073
2. Kollár hypersurfaces	1075
3. Explicit birational map for Kollár surfaces	1077
4. Kollár surfaces are Hwang–Keum surfaces	1087
5. Kollár surfaces as branched covers of \mathbb{P}^2	1093
6. Theorems on geometric genus	1096
Acknowledgements	1104
References	1104

1. Introduction

The ground field is \mathbb{C} . Let $n \geq 3$ be an integer, and let a_1, \dots, a_n be positive integers such that there is no $(a_i, a_{i+2}, \dots, a_{i+n-2}) = (1, \dots, 1)$ when n is even. The indices are and will be taken modulo n . For every $1 \leq i \leq n$, we define the positive integers

$$W_i := \sum_{j=1}^n (-1)^{j-1} \prod_{l=i+j}^{i+n-1} a_l \quad \text{and} \quad D := \prod_{l=1}^n a_l + (-1)^{n-1}.$$

MSC2010: 14J10.

Keywords: \mathbb{Q} -homology projective planes, Dedekind sums, branched covers.

For example, for $n = 4$ we have

$$W_i = a_{i+1}a_{i+2}a_{i+3} - a_{i+2}a_{i+3} + a_{i+3} - 1 \quad \text{and} \quad D = a_1a_2a_3a_4 - 1.$$

We also define

$$w^* := \gcd(W_1, \dots, W_n).$$

Then $w^* = \gcd(W_i, W_{i+1}) = \gcd(W_i, D)$ since $a_i W_i + W_{i+1} = D$ for all i .

Set

$$w_i := \frac{W_i}{w^*} \quad \text{and} \quad d := \frac{D}{w^*}.$$

Notice that $\gcd(a_i, w^*) = 1$ for all i .

The *Kollár hypersurface* [2008] of type (a_1, \dots, a_n) is

$$X(a_1, \dots, a_n) := (x_1^{a_1} x_2 + x_2^{a_2} x_3 + \dots + x_n^{a_n} x_1 = 0) \subset \mathbb{P}(w_1, \dots, w_n).$$

Let $0 < \mu_i < w^*$ be such that $\mu_i \equiv (-1)^{i+1} \prod_{l=i+1}^{i+n-1} a_l \pmod{w^*}$. We consider the normal projective variety Y' given by the w^* -th root cover $Y' \rightarrow \mathbb{P}^{n-2} = \{y_1 + \dots + y_n = 0\} \subset \mathbb{P}^{n-1}$ branched along $\{y_1^{\mu_1} \dots y_n^{\mu_n} = 0\}$; see Section 2 for precise definitions. The map ψ associated to the linear system $|x_1^{a_1} x_2, \dots, x_n^{a_n} x_1|$ in the Kollár hypersurface shows that the varieties $X(a_1, \dots, a_n)$ and Y' are birational; this is worked out in Section 2.

In this paper we consider in detail the case $n = 4$; the surface $X = X(a_1, \dots, a_4)$ will be called *Kollár surface*. First, we note that Kollár surfaces are birational to infinitely many Kollár surfaces with $\gcd(w_i, w_{i+2}) = 1$ and $a_i > 1$ (see Theorem 5.1), and so we assume these numerical conditions to simplify the exposition. Section 3 is devoted to proving:

Theorem 1.1. *There is a configuration Γ of six rational curves in X such that, if $\widehat{X} \rightarrow X$ is a log resolution of (X, Γ) , then $\widehat{X} \rightarrow X \xrightarrow{\psi} \mathbb{P}^2$ is a morphism which factors through $Y' \rightarrow \mathbb{P}^2$ via a birational morphism $\widehat{X} \rightarrow Y'$.*

The aim of Kollár surfaces [2008] was to give examples of rational \mathbb{Q} -homology projective planes (\mathbb{Q} HPP) with ample canonical class. This occurs for $w^* = 1$ after contracting $(x_1 = x_3 = 0)$ and $(x_2 = x_4 = 0)$ in X , when these two curves have negative self-intersections (see Corollary 4.8). This contraction gives a \mathbb{Q} HPP with two cyclic quotient singularities, and when $a_i \geq 4$ for all i , the canonical class is ample. On the other hand, Hwang and Keum [2012] constructed a series of examples of \mathbb{Q} HPP with ample canonical class and same singularities as Kollár examples. In Section 4 we prove:

Theorem 1.2. *Kollár \mathbb{Q} -homology projective planes are Hwang–Keum surfaces.*

As an intriguing problem, we point out that rational \mathbb{Q} HPP with ample canonical class and cyclic quotient singularities have not yet been classified. The number of possible singularities is at most four, and examples with one, two, and three singularities have been constructed. It is conjectured that the case of four singularities is impossible [Kollár 2008; Hwang and Keum 2012].

In Section 5 we write down formulas for the invariants of Kollár surfaces via Y' when $w^* > 1$. Particularly interesting is the geometric genus, which depends on classical Dedekind sums on the exponents a_i . For example, by comparing the two models X and Y' , we write down an identity for Dedekind sums in Corollary 5.8. More importantly, in Section 6 we use new bounds on their values, essentially due to Girstmair [2017], to prove (see Theorems 6.3, 6.6, and 6.11):

Theorem 1.3. *For $w^* > 1$, we have:*

- (a) $p_g = 0$ if and only if the Kollár surface is rational. This happens when $a_i \equiv 1$ or $a_i a_{i+1} \equiv -1$ modulo w^* for some i .
- (b) $p_g = 1$ if and only if the Kollár surface is birational to a K3 surface. We classify this situation in eight cases (see Table 1).
- (c) For $w^* \gg 0$, the smooth minimal model S of a generic Kollár surface is of general type with $K_S^2/e(S) \rightarrow 1$, where K_S is the canonical class, and $e(S)$ is the topological Euler characteristic.

Moreover, we note that any p_g is realizable by some Kollár surface (Proposition 6.2), and that given $m > 0$ there exists an N such that $p_g > m$ if $w^* > N$ (Lemma 6.7). At the end, we give explicit examples of Kodaira dimension-1 elliptic fibrations (Example 6.9) and surfaces of general type (Example 6.10), arising as Kollár surfaces for w^* arbitrarily large.

2. Kollár hypersurfaces

Kollár [2008, Theorem 39] proves:

- Theorem 2.1.** (1) *The weighted projective space $\mathbb{P}(w_1, \dots, w_n)$ is well formed, and its singular set has dimension $\leq [n/2] - 1$.*
- (2) *The hypersurface $X(a_1, \dots, a_n)$ is quasismooth, and $\mathbb{P}(w_1, \dots, w_n) \setminus X(a_1, \dots, a_n)$ is smooth.*
- (3) *If $w^* = 1$, then $X(a_1, \dots, a_n)$ is birational to \mathbb{P}^{n-2} .*

To prove (3) above, Kollár uses the linear system $|x_1^{a_1} x_2, x_2^{a_2} x_3, \dots, x_n^{a_n} x_1|$. In general, this linear system defines a rational map

$$\psi : \mathbb{P}(w_1, \dots, w_n) \dashrightarrow \mathbb{P}_{y_1, \dots, y_n}^{n-1}$$

given by $y_i = x_i^{a_i} x_{i+1}$.

Proposition 2.2. *The rational map ψ defines the field extension*

$$\mathbb{C}(y_1/y_n, \dots, y_{n-1}/y_n) \subset \mathbb{C}(y_1/y_n, \dots, y_{n-1}/y_n)[z]/(z^{w^*} - f/y_n^{W_1})$$

where $z = x_1^d/y_n^{w_1}$ and $f = y_1^{a_2 a_3 \dots a_n} y_2^{-a_3 \dots a_n} y_3^{a_4 \dots a_n} \dots y_{n-1}^{(-1)^{n-2} a_n} y_n^{(-1)^{n-1}}$.

Proof. At the affine cover level, the field extension induced by ψ is

$$\mathbb{C}(y_1, \dots, y_n) \subset \mathbb{C}(y_1, \dots, y_n)[x_1]/(x_1^D - f)$$

where the other variables x_2, \dots, x_n can be written using y_1, \dots, y_n, x_1 . The action of \mathbb{C}^* compatible with the map is: given $\lambda \in \mathbb{C}^*$, $y_i \mapsto \lambda^d y_i$ and $x_i \mapsto \lambda^{w_i} x_i$. Then the rational map ψ is determined by

$$(\mathbb{C}(y_1, \dots, y_n))^{\mathbb{C}^*} \subset (\mathbb{C}(y_1, \dots, y_n)[x_1]/(x_1^D - f))^{\mathbb{C}^*}.$$

Notice that $(\mathbb{C}(y_1, \dots, y_n))^{\mathbb{C}^*} = \mathbb{C}(y_1/y_n, \dots, y_{n-1}/y_n)$, and that $z = x_1^d/y_n^{w_1}$ is a \mathbb{C}^* -invariant element such that $z^{w^*} - f/y_n^{W_1} = 0$. Since geometrically the map ψ has degree w^* , then

$$(\mathbb{C}(y_1, \dots, y_n)[x_1]/(x_1^D - f))^{\mathbb{C}^*} = \mathbb{C}(y_1/y_n, \dots, y_{n-1}/y_n)[z]/(z^{w^*} - f/y_n^{W_1}). \quad \square$$

Corollary 2.3. *The corresponding restriction map*

$$\psi|_X : X(a_1, \dots, a_n) \dashrightarrow \mathbb{P}^{n-2} = \{y_1 + \dots + y_n = 0\}$$

is cyclic of degree w^* totally branched along $(y_1 \cdots y_n = 0) \subset \mathbb{P}^{n-2}$.

In this way, we can write down another normal projective model Y' of $X(a_1, \dots, a_n)$ using a w^* -th root cover as described in [Esnault and Viehweg 1992].

As in the introduction, let $0 < \mu_i < w^*$ be such that

$$\mu_i \equiv (-1)^{i+1} \prod_{l=i+1}^{i+n-1} a_l \pmod{w^*}.$$

In $\mathbb{P}^{n-2} = \{y_1 + \dots + y_n = 0\}$, we write $L_i := \{y_i = 0\}$, and so

$$\mathbb{O}_{\mathbb{P}^{n-2}}(w_1)^{\otimes w^*} \simeq \mathbb{O}_{\mathbb{P}^{n-2}}(\mu_1 L_1 + \dots + \mu_n L_n),$$

where $w_1 w^* = W_1 = \sum_{i=1}^n \mu_i$. Then

$$Y_0 := \text{Spec}_{\mathbb{P}^{n-2}} \left(\bigoplus_{i=0}^{w^*-1} \mathbb{O}_{\mathbb{P}^{n-2}}(-w_1 i) \right) \rightarrow \mathbb{P}^{n-2}$$

is the cyclic cover given by $z^{w^*} - f/y_n^{W_1}$ above. We want to consider the normalization of Y_0 . As in [Esnault and Viehweg 1992], we define the line bundles $\mathcal{L}^{(i)}$ on \mathbb{P}^{n-2} as

$$\mathcal{L}^{(i)} := \mathbb{O}_{\mathbb{P}^{n-2}}(w_1 i) \otimes \mathbb{O}_{\mathbb{P}^{n-2}} \left(- \sum_{j=1}^n \left[\frac{\mu_j i}{w^*} \right] L_j \right)$$

for $i \in \{0, 1, \dots, w^* - 1\}$, where $[x]$ is the integer part of x . Then the normalization of Y_0 is $Y' := \text{Spec}_{\mathbb{P}^{n-2}} \left(\bigoplus_{i=0}^{w^*-1} \mathcal{L}^{(i)-1} \right)$ [Esnault and Viehweg 1992, Corollary 3.11]. Notice that $\text{gcd}(\mu_i, w^*) = 1$, and so this cyclic morphism is totally branched at the L_i .

Corollary 2.4. *There is a birational map $X(a_1, \dots, a_n) \dashrightarrow Y'$.*

In the next section we describe explicitly this birational map for $n = 4$.

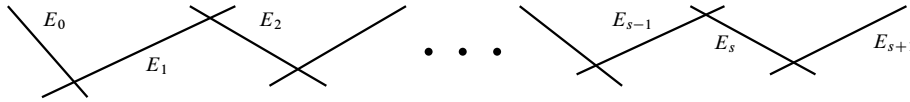

Figure 1. Exceptional divisors over $\frac{1}{m}(1, q)$, E_0 , and E_{s+1} .

3. Explicit birational map for Kollár surfaces

From now on we concentrate in the case of Kollár surfaces, where $n = 4$. We will be working with cyclic quotient surface singularities, which we now review. A cyclic quotient singularity S , denoted by $\frac{1}{m}(a, b)$, is a germ at the origin of the quotient of \mathbb{C}^2 by the action $(x, y) \mapsto (\zeta^a x, \zeta^b y)$, where ζ is a primitive m -th root of 1, and a, b are integers coprime to m [Barth et al. 2004, §III.5]. Let $0 < q < m$ be such that $aq - b \equiv 0$ modulo m . Then $\frac{1}{m}(a, b) = \frac{1}{m}(1, q)$. Let $\sigma : \tilde{S} \rightarrow S$ be the minimal resolution of S . Figure 1 shows the exceptional curves $E_i = \mathbb{P}^1$ of σ , for $1 \leq i \leq s$, and the strict transforms E_0 and E_{s+1} of $(y = 0)$ and $(x = 0)$, respectively.

The numbers $E_i^2 = -b_i$ are computed using the *Hirzebruch–Jung continued fraction*

$$\frac{m}{q} = b_1 - \frac{1}{b_2 - \frac{1}{\ddots - \frac{1}{b_s}}}$$

We denote $||[b_1, \dots, b_s]|| := m$. This continued fraction defines the sequence of integers

$$0 = \beta_{s+1} < 1 = \beta_s < \dots < q = \beta_1 < m = \beta_0$$

where $\beta_{i+1} = b_i \beta_i - \beta_{i-1}$. In this way, $\beta_{i-1}/\beta_i = [b_i, \dots, b_s]$. Partial fractions $\alpha_i/\gamma_i = [b_1, \dots, b_{i-1}]$ are computed through the sequences

$$0 = \alpha_0 < 1 = \alpha_1 < \dots < q^{-1} = \alpha_s < m = \alpha_{s+1},$$

where $\alpha_{i+1} = b_i \alpha_i - \alpha_{i-1}$ (q^{-1} is the integer such that $0 < q^{-1} < m$ and $qq^{-1} \equiv 1 \pmod{m}$), and $\gamma_0 = -1$, $\gamma_1 = 0$, and $\gamma_{i+1} = b_i \gamma_i - \gamma_{i-1}$. We have $\alpha_{i+1} \gamma_i - \alpha_i \gamma_{i+1} = -1$, $\beta_i = q \alpha_i - m \gamma_i$, and $m/q^{-1} = [b_s, \dots, b_1]$. These numbers appear in the pull-back formulas

$$\sigma^*((y = 0)) = \sum_{i=0}^{s+1} \frac{\beta_i}{m} E_i \quad \text{and} \quad \sigma^*((x = 0)) = \sum_{i=0}^{s+1} \frac{\alpha_i}{m} E_i, \tag{3-1}$$

and $K_{\tilde{S}} \equiv \sigma^*(K_S) + \sum_{i=1}^s (-1 + (\beta_i + \alpha_i)/m) E_i$.

Let $X(a_1, a_2, a_3, a_4)$ be a Kollár surface. Let

$$p_1 = (1 : 0 : 0 : 0), \quad p_2 = (0 : 1 : 0 : 0), \quad p_3 = (0 : 0 : 1 : 0), \quad p_4 = (0 : 0 : 0 : 1).$$

Proposition 3.1. *The surface $X(a_1, a_2, a_3, a_4)$ is normal and has only singularities of type $\frac{1}{w_i}(w_{i+2}, w_{i+3})$ at the points p_i when $\gcd(w_i, w_{i+2}) = 1$, and of type $\frac{1}{t_i}(t_{i+2}, w_{i+3})$ when $\gcd(w_i, w_{i+2}) = h > 1$, where $w_j = ht_j$.*

Proof. Here we follow the idea in [Iano-Fletcher 2000, §10.1]. Without loss of generality, it is enough to check the singularity at p_1 . Consider the affine cone $C_X \subset \mathbb{C}^4$ of $X(a_1, a_2, a_3, a_4)$ and the corresponding action of \mathbb{C}^* given by,

$$\lambda \in \mathbb{C}^*, \quad \lambda \cdot (x_1, x_2, x_3, x_4) = (\lambda^{w_1}x_1, \lambda^{w_2}x_2, \lambda^{w_3}x_3, \lambda^{w_4}x_4).$$

Then to study the singularities around p_1 , we check how the action behaves when we restrict to $(x_1 = 1)$. Notice that, when $x_1 \neq 0$,

$$\frac{\partial}{\partial x_2}(x_1^{a_1}x_2 + x_2^{a_2}x_3 + x_3^{a_3}x_4 + x_4^{a_4}x_1) = x_1^{a_1} + a_2x_2^{a_2-1}x_3 \neq 0,$$

so locally, by the implicit function theorem, we can write x_2 as a function of x_3 and x_4 , which become local parameters. Then the action of \mathbb{C}^* restricted to $(x_1 = 1)$ is

$$\zeta_1 \cdot (1, x_2, x_3, x_4) = (1, \zeta_1^{w_2}x_2, \zeta_1^{w_3}x_3, \zeta_1^{w_4}x_4),$$

where ζ_1 is a w_1 -th primitive root of 1. Therefore, after taking the quotient, the singularity is a cyclic singularity of type $\frac{1}{w_1}(w_3, w_4)$, if $\gcd(w_1, w_3) = 1$. If $\gcd(w_1, w_3) = h > 1$, then there are elements which fix the axis $(x_3 = 0)$, so they are quasireflections. We eliminate them by dividing $w_1 = ht_1$ and $w_3 = ht_3$ by h , obtaining that the singularity is $\frac{1}{t_1}(t_3, w_4)$. \square

Assume $a_i \geq 2$ for all i .¹ We have this key configuration of curves on $X(a_1, a_2, a_3, a_4)$ (Figure 2):

$$\begin{aligned} C_1 &:= (x_1 = x_3 = 0), \\ C_2 &:= (x_2 = x_4 = 0), \\ \Gamma_{1,2} &:= (x_3 = x_4^{a_4} + x_1^{a_1-1}x_2 = 0), \\ \Gamma_{2,3} &:= (x_4 = x_1^{a_1} + x_2^{a_2-1}x_3 = 0), \\ \Gamma_{3,4} &:= (x_1 = x_2^{a_2} + x_3^{a_3-1}x_4 = 0), \\ \Gamma_{4,1} &:= (x_2 = x_3^{a_3} + x_4^{a_4-1}x_1 = 0). \end{aligned}$$

Proposition 3.2. *The curves C_1, C_2 are smooth and rational. The curve $\Gamma_{i,j}$ is rational, and it may only have a unibranch singularity at p_j .*

Proof. The curves C_1, C_2 are obviously isomorphic to \mathbb{P}^1 . To prove the assertion about $\Gamma_{i,j}$, it is enough to do it for $\Gamma_{2,3}$. Notice that this curve lives in $(x_4 = 0) = \mathbb{P}(w_1, w_2, w_3)$, and that it is possibly singular only at $(0 : 0 : 1)$. Let us consider the $\mathbb{Z}/w_1 \oplus \mathbb{Z}/w_2 \oplus \mathbb{Z}/w_3$ quotient map

$$\mathbb{P}^2 \rightarrow \mathbb{P}(w_1, w_2, w_3)$$

¹This is to have the key configuration of curves as shown. By Theorem 5.1, Kollár surfaces with $a_i = 1$ are birationally included in our analysis. Also, check Corollary 4.8 when $w^* = 1$.

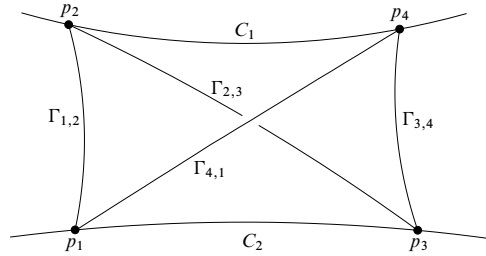

Figure 2. Key configuration of curves on a Kollár surface.

given by $(x : y : z) \mapsto (x^{w_1} : y^{w_2} : z^{w_3})$. Then the preimage of $\Gamma_{2,3}$ is

$$\Gamma'_{2,3} = (x^{w_1 a_1} + y^{w_2(a_2-1)} z^{w_3} = 0),$$

and so $\Gamma_{2,3}$ is rational since all irreducible components (branches at $(0 : 0 : 1)$) of $\Gamma'_{2,3}$ are rational curves.

To see that $\Gamma_{2,3}$ is unibranch at $(0 : 0 : 1)$, we will show that the (possible) branches of $\Gamma'_{2,3}$ form one orbit under the $\mathbb{Z}/w_1 \oplus \mathbb{Z}/w_2 \oplus \mathbb{Z}/w_3$ action. We take the canonical affine chart at $(0 : 0 : 1)$, where $\Gamma'_{2,3} = (x^{w_1 a_1} + y^{w_2(a_2-1)} = 0)$. We consider the action of \mathbb{Z}/w_3 given by $(x, y) \mapsto (\zeta_3^k x, \zeta_3^k y)$ where $k \in \mathbb{Z}$ and $\zeta_3 = e^{2\pi i/w_3}$. Notice that $\gcd(w_2, w_1) = 1$ and $\gcd(w_2, a_1) = 1$ by definition, and so we write $a_2 - 1 = rb$ and $w_1 a_1 = ra$ where $\gcd(a, b) = 1$, to factor in branches

$$x^{w_1 a_1} + y^{w_2(a_2-1)} = \prod_{c=0}^{r-1} (y^{w_2 b} - \zeta_{2r}^{2c+1} x^a)$$

where $\zeta_{2r} = e^{\pi i/r}$. Then we take $y^{w_2 b} - \zeta_{2r} x^a$ and apply $(x, y) \mapsto (\zeta_3^k x, \zeta_3^k y)$ to obtain the branch $y^{w_2 b} - \zeta_{2r} \zeta_3^{k(a-w_2 b)} x^a$, but $a - w_2 b = w_3/r$, and so it goes to $y^{w_2 b} - \zeta_{2r}^{2k+1} x^a$. Therefore, branches form one orbit, and the curve $\Gamma_{2,3}$ is unibranch at $(0 : 0 : 1)$. \square

Proposition 3.3. Assume that $a_i > w^*$ for some i . Then $\Gamma_{i+2, i+3}$ is nonsingular.

Proof. We take $a_1 > w^*$ to prove that $\Gamma_{3,4}$ is nonsingular. For this we will compute the arithmetic genus of $\Gamma_{3,4}$. Let $\mathbb{P} = \mathbb{P}(w_2, w_3, w_4)$, and consider the exact sequence of sheaves $0 \rightarrow \mathcal{O}_{\mathbb{P}}(-a_2 w_2) \rightarrow \mathcal{O}_{\mathbb{P}} \rightarrow \mathcal{O}_{\Gamma_{3,4}} \rightarrow 0$. From it we have that $\chi(\mathcal{O}_{\Gamma_{3,4}}) = \chi(\mathcal{O}_{\mathbb{P}}) - \chi(\mathcal{O}_{\mathbb{P}}(-a_2 w_2))$. If $\gcd(w_2, w_4) = 1$, then by [Dolgachev 1982, §1.4] we have that $\chi(\mathcal{O}_{\mathbb{P}}) - \chi(\mathcal{O}_{\mathbb{P}}(-a_2 w_2)) = 1 - h^0(\mathbb{P}, \mathcal{O}_{\mathbb{P}}(a_2 w_2 - w_2 - w_3 - w_4))$. Then

$$p_a(\Gamma_{3,4}) = 1 - \chi(\mathcal{O}_{\Gamma_{3,4}}) = h^0(\mathbb{P}, \mathcal{O}_{\mathbb{P}}(a_2 w_2 - w_2 - w_3 - w_4)),$$

so we have to compute the number of nonnegative integer solutions of the equation $w_2 x + w_3 y + w_4 z = a_2 w_2 - w_2 - w_3 - w_4$. As $a_2 w_2 + w_3 = a_3 w_3 + w_4$, then our equation can be written as

$$w_2(x + a_2 z) + w_3(y + (1 - a_3)z) = (a_3 - 2)w_3 - w_2$$

and its solutions are

$$x = -1 - t w_3 - a_2 z, \quad y = a_3 - 2 + t w_2 + (a_3 - 1)z, \quad z = z. \tag{3-2}$$

If $x, y,$ and z are nonnegative, then $t < 0$, so we will change the sign of t and assume that $t > 0$. Then from (3-2) we obtain that

$$a_2z \leq tw_3 - 1$$

and $(a_3 - 1)z \geq tw_2 - a_3 + 2$. Hence, we have that

$$\frac{tw_3 - 1}{a_2} \geq z \geq \frac{tw_2 + 2 - a_3}{a_3 - 1}. \tag{3-3}$$

Replacing with $w_2 = \frac{1}{w^*}(a_3a_4a_1 - a_4a_1 + a_1 - 1)$ and $w_3 = \frac{1}{w^*}(a_4a_1a_2 - a_1a_2 + a_2 - 1)$ we obtain

$$ta_4a_1 - t(a_1 - 1) - \frac{t + w^*}{a_2} \geq w^*z \geq ta_4a_1 - w^* + \frac{t(a_1 - 1) + w^*}{a_3 - 1}.$$

Because $a_1 > w^*$ and $t \geq 1$, then $t(a_1 - 1) \geq w^*$, so $ta_4a_1 - w^* \geq ta_4a_1 - t(a_1 - 1)$. We have that both $(t + w^*)/a_2$ and $(t(a_1 - 1) + w^*)/(a_3 - 1)$ are positive; therefore, the right-hand side of the system (3-3) is greater than the left-hand side, so the system has no solution. Hence, the arithmetic genus of $\Gamma_{3,4}$ is zero and therefore nonsingular.

If $\gcd(w_2, w_4) = h > 1$, then $p_a(\Gamma_{3,4}) = h^1(\mathbb{P}, \mathcal{O}_{\mathbb{P}}(-a_2w_2))$. To compute it, we first have to consider the well formed weighted projective plane $\mathbb{P}' = \mathbb{P}(t_2, w_3, t_4) \simeq \mathbb{P}$, where $t_2 = w_2/h$ and $t_4 = w_4/h$, and following [Dolgachev 1982, Remarks 1.3.2], we have that $\mathcal{O}_{\mathbb{P}}(-a_2w_2) \simeq \mathcal{O}_{\mathbb{P}'}(-a_2t_2)$. Then $p_a(\Gamma_{3,4}) = h^0(\mathbb{P}', \mathcal{O}_{\mathbb{P}'}(a_2t_2 - t_2 - w_3 - t_4))$, which is equivalent to the number of nonnegative integer solutions of the equation

$$t_2x + w_3y + t_4z = a_2t_2 - t_2 - w_3 - t_4.$$

The general solution of this equation is

$$x = -1 - tw_3 - a_2z, \quad y = \frac{a_3 - 1}{h} - 1 + t_2t + \frac{a_3 - 1}{h}z, \quad z = z,$$

with $t \in \mathbb{Z}$. Then $t < 0$, and changing the sign of t as above, we have that the arithmetic genus is equal to the number of solutions of the system

$$a_1a_4t - t(a_1 - 1) - \frac{t + w^*}{a_2} \geq w^*z \geq a_1a_4t - w^* + \frac{hw^* + (a_1 - 1)t}{a_3 - 1},$$

but again, as $a_i > w^*$, then the right-hand side is greater than the left-hand side, so the arithmetic genus is 0. □

Proposition 3.4. *The map ψ is defined precisely in $X(a_1, a_2, a_3, a_4) \setminus \{p_1, p_2, p_3, p_4\}$, and it contracts*

$$\begin{aligned} \psi(C_1 \setminus \{p_2, p_4\}) &= (0 : 1 : 0 : -1), & \psi(C_2 \setminus \{p_1, p_3\}) &= (1 : 0 : -1 : 0), \\ \psi(\Gamma_{1,2} \setminus \{p_1, p_2\}) &= (-1 : 0 : 0 : 1), & \psi(\Gamma_{2,3} \setminus \{p_2, p_3\}) &= (1 : -1 : 0 : 0), \\ \psi(\Gamma_{3,4} \setminus \{p_3, p_4\}) &= (0 : 1 : -1 : 0), & \psi(\Gamma_{4,1} \setminus \{p_4, p_1\}) &= (0 : 0 : 1 : -1). \end{aligned}$$

Proof. We have that $\psi|_{\Gamma_{1,2} \setminus \{p_1, p_2\}} = (x_1^{a_1-1}x_2 : 0 : 0 : x_4^{a_4})$, and because $x_1^{a_1-1}x_2 = -x_4^{a_4}$ over $\Gamma_{1,2}$, then $\psi|_{\Gamma_{1,2} \setminus \{p_1, p_2\}} = (-1 : 0 : 0 : 1)$. This gives the result for all curves $\Gamma_{i,i+1}$.

For C_1 , let $x_4 = 1$ and $x_2 = b \neq 0$. Then the equation of the surface with these restrictions is

$$bx_1^{a_1} + b^{a_2}x_3 + x_3^{a_3} + x_1 = x_1(1 + bx_1^{a_1-1}) + x_3(b^{a_2} + x_3^{a_3-1}) = 0.$$

The map is $\psi(x_1 : b : x_3 : 1) = (bx_1^{a_1} : b^{a_2}x_3 : x_3^{a_3} : x_1)$. We multiply every coordinate by $(1 + bx_1^{a_1-1})$, and use the relation $x_1(1 + bx_1^{a_1-1}) = -x_3(b^{a_2} + x_3^{a_3-1})$, to write down $\psi(x_1 : b : x_3 : 1)$ as

$$\begin{aligned} & (bx_1^{a_1}(1 + bx_1^{a_1-1}) : b^{a_2}x_3(1 + bx_1^{a_1-1}) : x_3^{a_3}(1 + bx_1^{a_1-1}) : x_1(1 + bx_1^{a_1-1})) \\ &= (-x_3bx_1^{a_1-1}(b^{a_2} + x_3^{a_3-1}) : b^{a_2}x_3(1 + bx_1^{a_1-1}) : x_3^{a_3}(1 + bx_1^{a_1-1}) : -x_3(b^{a_2} + x_3^{a_3-1})) \\ &= (-bx_1^{a_1-1}(b^{a_2} + x_3^{a_3-1}) : b^{a_2}(1 + bx_1^{a_1-1}) : x_3^{a_3-1}(1 + bx_1^{a_1-1}) : -(b^{a_2} + x_3^{a_3-1})). \end{aligned}$$

Hence, $\psi(0 : b : 0 : 1) = (0 : b^{a_2} : 0 : -b^{a_2}) = (0 : 1 : 0 : -1)$. A similar argument works for C_2 . □

Remark 3.5. By Theorem 5.1, we know that any $X(a_1, a_2, a_3, a_4)$ has a birational model $X(a'_1, a'_2, a'_3, a'_4)$ with $\gcd(w'_i, w'_{i+2}) = 1$. From now on, we assume that $\gcd(w_1, w_3) = \gcd(w_2, w_4) = 1$.

Now we want to study the behavior of ψ on a resolution of the singularities in $X(a_1, a_2, a_3, a_4)$. To do so, we need to write this map in terms of local coordinates in the resolution, which are described in:

Theorem 3.6 [Reid 2003, Theorem 3.2]. *Let $X = \mathbb{C}^2 / (\mathbb{Z}/m)$ be a cyclic singularity of type $\frac{1}{m}(a, b)$, and let $\frac{1}{m}(a, b) = \frac{1}{m}(1, q)$ be as explained at the beginning of Section 3. Let N be the lattice $N = \mathbb{Z}^2 + \mathbb{Z} \cdot \frac{1}{m}(1, q)$, and*

$$M = \{(r, s) : r + qs \equiv 0 \pmod{m}\} \subset \mathbb{Z}^2$$

the dual lattice of invariant monomials under the action $(x, y) \mapsto (\zeta_m x, \zeta_m^q y)$ with ζ_m an m -th primitive root of unity.

Let $m/q = [b_1, \dots, b_s]$, and let z_0, z_1, \dots, z_{s+1} be vectors in N defined as

$$z_i = \frac{1}{m}(\alpha_i, \beta_i),$$

where α_i and β_i are as defined at the beginning of Section 3. Then for each $i = 0, \dots, s$, let u_i, v_i be monomials forming the dual basis of M to z_i, z_{i+1} ; that is, $u_i = (\beta_i, -\alpha_i)$ and $v_i = (-\beta_{i+1}, \alpha_{i+1})$.

Then X has a resolution of singularities $Y \rightarrow X$ constructed as

$$Y = U_0 \cup U_1 \cup \dots \cup U_s,$$

where $U_i \simeq \mathbb{C}^2$ with coordinates u_i, v_i .

The gluing $U_i \cup U_{i+1}$ and the morphism $Y \rightarrow X$ are both determined by the definition of u_i, v_i and they consist of

$$U_i \setminus (v_i = 0) \xrightarrow{\cong} U_{i+1} \setminus (u_{i+1} = 0) \quad \text{given by } u_{i+1} = v_i^{-1} \text{ and } v_{i+1} = u_i v_i^{b_i}.$$

It follows from the definition of the numbers α_i and β_i that $u_0 = x^m$ and $v_s = y^m$, and they satisfy the relations

$$x^m = u_i^{\alpha_{i+1}} v_i^{\alpha_i} \quad \text{and} \quad y^m = u_i^{\beta_{i+1}} v_i^{\beta_i}.$$

Theorem 3.7. *Let $\sigma : \widetilde{X} \rightarrow X(a_1, a_2, a_3, a_4)$ be the minimal resolution, and let*

$$\widehat{X} \xrightarrow{\psi} \widetilde{X} \xrightarrow{\sigma} X(a_1, a_2, a_3, a_4)$$

be the minimal log resolution of X together with the key configuration of curves. Then $\psi \circ \sigma \circ \varphi$ is a morphism; i.e., the indeterminacies of ψ can be resolved by $\sigma \circ \varphi$.

To prove Theorem 3.7 we have to compute the strict transform of the curves $\Gamma_{i,i+1}$ on \widetilde{X} . Let $E_{i,j}$ be the components of the exceptional divisor over the point p_i , let $\frac{1}{w_i}(w_{i+2}, w_{i+3}) = \frac{1}{w_i}(1, q_i)$, and let $\alpha_{i,j}$, $\beta_{i,j}$, and $\gamma_{i,j}$ be the integers defined for the continued fraction of w_i/q_i . Recall from the proof of Proposition 3.1 that x_{i+2} and x_{i+3} are toric local coordinates at p_i , so we have that $E_{i,0}$ and E_{i,s_i+1} are the strict transforms of $(x_{i+3} = 0)$ and $(x_{i+2} = 0)$ at the open set $(x_i \neq 0)$. This means that $E_{1,0} = E_{3,0}$ and $E_{2,0} = E_{4,0}$ and they correspond to the strict transforms of C_2 and C_1 , respectively. On the other hand, E_{i,s_i+1} corresponds to the strict transform of the curve $\Gamma_{i,i+1}$. (See Figure 3 to visualize the notation.) Then it remains to compute the strict transform of $\Gamma_{i,i+1}$ around the point p_{i+1} , and without loss of generality, we will compute the strict transform $\Gamma_{3,4}$ at the point p_4 . As all the results will hold locally for $\Gamma_{3,4}$, we can modify the following proofs for every $\Gamma_{i,i+1}$.

Proposition 3.8. *Let $U_{4,j}$ be the open sets of the resolution of $\frac{1}{w_4}(1, q_4)$ as defined in Theorem 3.6. Then the local equation of the strict transform of the curve $\Gamma_{3,4}$ restricted to the open set $U_{4,j}$ is*

$$\Gamma'_{34} = \begin{cases} 1 + u_j^{((a_3-1)\beta_{4,j+1}-a_2\alpha_{4,j+1})/w_4} v_j^{((a_3-1)\beta_{4,j}-a_2\alpha_{4,j})/w_4} = 0 & \text{if } a_2\alpha_{4,j+1} - (a_3 - 1)\beta_{4,j+1} \leq 0, \\ u_j^{(a_2\alpha_{4,j+1}-(a_3-1)\beta_{4,j+1})/w_4} v_j^{(a_2\alpha_{4,j}-(a_3-1)\beta_{4,j})/w_4} + 1 = 0 & \text{if } 0 \leq a_2\alpha_{4,j} - (a_3 - 1)\beta_{4,j}, \\ u_j^{(a_2\alpha_{4,j+1}-(a_3-1)\beta_{4,j+1})/w_4} + v_j^{((a_3-1)\beta_{4,j}-a_2\alpha_{4,j})/w_4} = 0 & \text{if } a_2\alpha_{4,j} - (a_3 - 1)\beta_{4,j} \leq 0 \\ & \leq a_2\alpha_{4,j+1} - (a_3 - 1)\beta_{4,j+1}. \end{cases}$$

Proof. We can assume that $x_4 = 1$ and $x_1 = 0$, so we must study the curve $(x_2^{a_2} + x_3^{a_3-1} = 0) \subset (x_4 \neq 0) \subset \mathbb{P}(w_2, w_3, w_4)$. By Theorem 3.6, to find the total transform of $\Gamma_{3,4}$ in U_i we replace x_2 and x_3 with $u_i^{\alpha_{4,i+1}/w_4} v_i^{\alpha_{4,i}/w_4}$ and $u_i^{\beta_{4,i+1}/w_4} v_i^{\beta_{4,i}/w_4}$, respectively, and so the total transform is

$$(u_i^{\alpha_{4,i+1}/w_4} v_i^{\alpha_{4,i}/w_4})^{a_2} + (u_i^{\beta_{4,i+1}/w_4} v_i^{\beta_{4,i}/w_4})^{a_3-1} = 0.$$

Recall that $\alpha_{4,i} < \alpha_{4,i+1}$ and $\beta_{4,i+1} < \beta_{4,i}$, so

$$a_2\alpha_{4,i} - (a_3 - 1)\beta_{4,i} < a_2\alpha_{4,i+1} - (a_3 - 1)\beta_{4,i+1}.$$

If both sides are negative, we factor out $(u_i^{\alpha_{4,i+1}/w_4} v_i^{\alpha_{4,i}/w_4})^{a_2}$. If both sides are positive, we factor out $(u_i^{\beta_{4,i+1}/w_4} v_i^{\beta_{4,i}/w_4})^{a_3-1}$. If $a_2\alpha_{4,i} - (a_3 - 1)\beta_{4,i} \leq 0 \leq a_2\alpha_{4,i+1} - (a_3 - 1)\beta_{4,i+1}$, we factor out $u_i^{((a_3-1)\beta_{4,i+1})/w_4}$ and $v_i^{a_2\alpha_{4,i}/w_4}$, obtaining what we wanted to prove. \square

By Proposition 3.8, the curve $\Gamma'_{3,4}$ intersects the exceptional divisor if and only if

$$a_2\alpha_{4,i} - (a_3 - 1)\beta_{4,i} \leq 0 \leq a_2\alpha_{4,i+1} - (a_3 - 1)\beta_{4,i+1}.$$

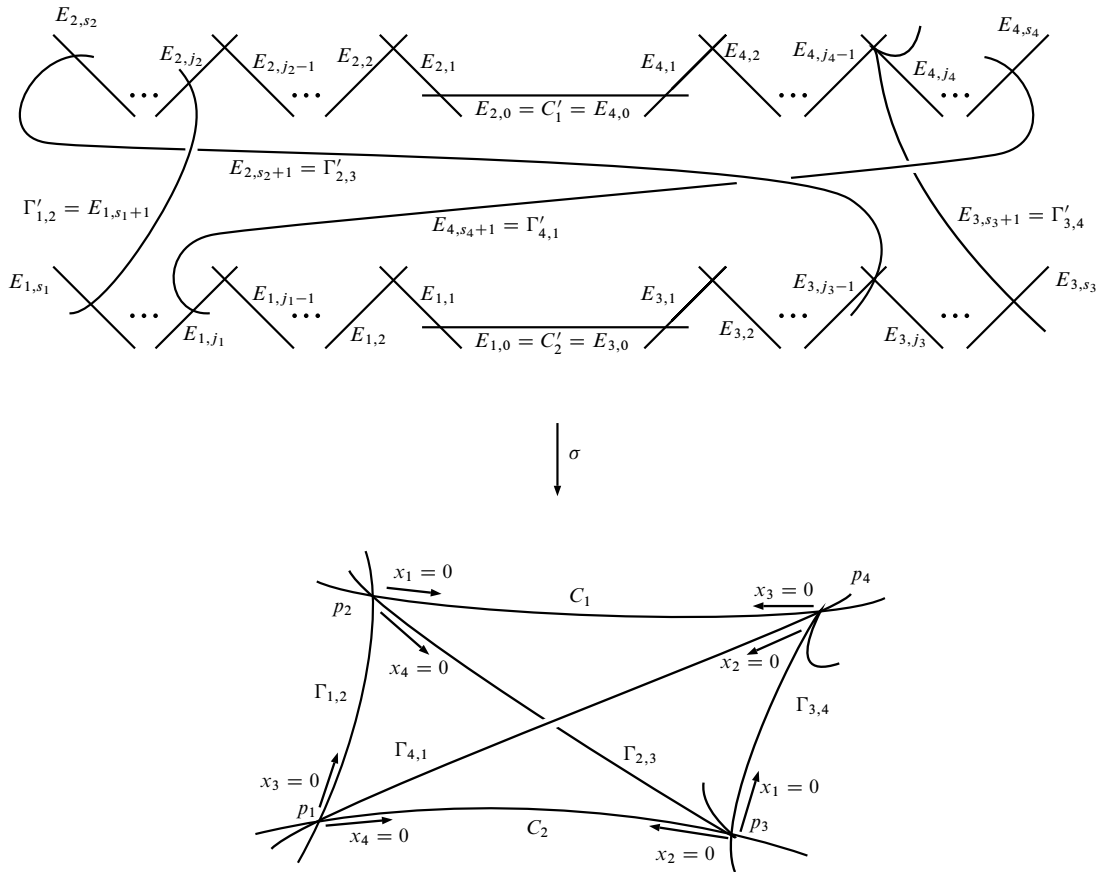

Figure 3. Key configuration of curves on $X(a_1, a_2, a_3, a_4)$ and the curve configuration of the minimal resolution \tilde{X} .

If $a_2\alpha_{4,i} - (a_3 - 1)\beta_{4,i} < 0 < a_2\alpha_{4,i+1} - (a_3 - 1)\beta_{4,i+1}$, then the curve intersects two components of the exceptional divisor, and if $a_2\alpha_{4,i} - (a_3 - 1)\beta_{4,i} = 0$ or $a_2\alpha_{4,i+1} - (a_3 - 1)\beta_{4,i+1} = 0$, then it intersects only one component.

Proposition 3.9. *Let us say that $\Gamma'_{3,4}$ intersects the exceptional divisor over p_4 at the components $E_{4,j}$ and $E_{4,j+1}$ with multiplicity m_j and m_{j+1} , respectively (possibly $m_{j+1} = 0$). Then $a_3 - 1 = \alpha_{4,j}m_j + \alpha_{4,j+1}m_{j+1}$ and $a_2 = \beta_{4,j}m_j + \beta_{4,j+1}m_{j+1}$.*

Proof. Let H be the restriction to $X(a_1, a_2, a_3, a_4)$ of a generator of the class group of $\mathbb{P}(w_1, w_2, w_3, w_4)$. We have that

$$w_1H \cdot w_2H = \frac{w_1w_2(a_3w_3 + w_4)}{w_1w_2w_3w_4} = \frac{1}{w_3} + \frac{a_3}{w_4}.$$

On the other hand, $w_1H \cdot w_2H = \sigma^*(w_1H) \cdot \sigma^*(w_2H)$, where $\sigma^*(w_1H) = \sigma^*(\Gamma_{3,4} + C_1)$, and $\sigma^*(w_2H) = \sigma^*(\Gamma_{4,1} + C_2)$. Because the pull-back of a divisor has intersection zero with any component of the

exceptional divisor, and using the pull-back formulas in (3-1), we have that

$$\begin{aligned} \sigma^*(w_1H) \cdot \sigma^*(w_2H) &= (\Gamma'_{3,4} + C'_1) \cdot \left(\sum_{i=0}^{s_3+1} \frac{\beta_{3,i}}{w_3} E_{3,i} + \sum_{i=0}^{s_4+1} \frac{\alpha_{4,i}}{w_4} E_{4,i} \right) \\ &= \Gamma'_{3,4} \cdot \sum_{i=0}^{s_3+1} \frac{\beta_{3,i}}{w_3} E_{3,i} + C'_1 \cdot \sum_{i=0}^{s_4+1} \frac{\alpha_{4,i}}{w_4} E_{4,i} + \Gamma'_{3,4} \cdot \sum_{i=0}^{s_4+1} \frac{\alpha_{4,i}}{w_4} E_{4,i} \\ &= \frac{1}{w_3} + \frac{1}{w_4} + \sum_{i=0}^{s_4+1} \frac{\alpha_{4,i}}{w_4} \Gamma'_{3,4} \cdot E_{4,i}. \end{aligned}$$

Then $a_3 - 1 = \alpha_{4,j} \Gamma'_{3,4} \cdot E_{4,j} + \alpha_{4,j+1} \Gamma'_{3,4} \cdot E_{4,j+1} = \alpha_{4,j} m_j + \alpha_{4,j+1} m_{j+1}$. To simplify the computation of the second equality, we will restrict to the plane $\mathbb{P}(w_2, w_3, w_4)$, with L a generator of the class group. We can do this because at the point p_4 the singularity is the same as the one at the point $(0 : 0 : 1) \in \mathbb{P}(w_2, w_3, w_4)$, so locally σ does not change.

Then $w_3L \cdot a_2w_2L = a_2w_2w_3/(w_2w_3w_4) = a_2/w_4$ and also

$$\sigma^*(w_3L) \cdot \sigma^*(a_2w_2L) = \Gamma'_{3,4} \cdot \sum_{i=0}^{s_4+1} \frac{\beta_{4,i}}{w_4} E_{4,i},$$

where $\sigma^*(w_3L) = \sigma^*(C_1)$ and $\sigma^*(a_2w_2L) = \sigma^*(\Gamma_{3,4})$. Then $a_2 = \beta_{4,j} m_j + \beta_{4,j+1} m_{j+1}$. □

Corollary 3.10. *If $\Gamma'_{3,4}$ intersects the exceptional divisor in one component, then it does it transversally at one point.*

Proof. Recall that in the open subset $U_{4,i}$, the exponents of the variables u_i and v_i of the strict transform of $\Gamma_{3,4}$ are $\pm(a_2\alpha_{4,i+1} - (a_3 - 1)\beta_{4,i+1})/w_4$ and $\pm(a_2\alpha_{4,i} - (a_3 - 1)\beta_{4,i})/w_4$.

Suppose that $\Gamma'_{3,4}$ intersects E_j with multiplicity m_j . Then, using Proposition 3.9, we have that $a_2 = \beta_{4,j} m_j + \beta_{4,j+1} m_{j+1}$ and $a_3 - 1 = \alpha_{4,j} m_j + \alpha_{4,j+1} m_{j+1}$, and in this case $m_{j+1} = 0$. Hence, for all i

$$\frac{a_2\alpha_{4,i} - (a_3 - 1)\beta_{4,i}}{w_4} = m_j \frac{\beta_{4,j}\alpha_{4,i} - \alpha_{4,j}\beta_{4,i}}{w_4},$$

but the singularity at p_4 was unibranch, so it is locally irreducible. Therefore, the exponents on the resolution must be relatively prime. Thus, $m_j = 1$. □

Theorem 3.11. *The curve $\Gamma'_{3,4}$ intersects the exceptional divisor in one component if and only if $\psi \circ \sigma$ is defined on the whole exceptional divisor over p_4 .*

Proof. The equation of our surface is $x_1^{a_1} x_2 + x_2^{a_2} x_3 + x_3^{a_3} x_4 + x_4^{a_4} x_1 = 0$, so locally at p_4 our surface is $(x_1^{a_1} x_2 + x_2^{a_2} x_3 + x_3^{a_3} + x_1 = 0)$. Then analytically the power series expansion of x_1 in terms of x_2 and x_3 is

$$x_1 = -x_2^{a_2} x_3 - x_3^{a_3} + (\text{higher order terms in } x_2 \text{ and } x_3).$$

Therefore, at the open set U_i

$$\sigma^*(x_1) = -(u_i^{\alpha_{4,i+1}/w_4} v_i^{\alpha_{4,i}/w_4}) a_2 (u_i^{\beta_{4,i+1}/w_4} v_i^{\beta_{4,i}/w_4}) - (u_i^{\beta_{4,i+1}/w_4} v_i^{\beta_{4,i}/w_4}) a_3 + (\text{higher order terms}),$$

and so

$$\begin{aligned} \psi \circ \sigma|_{U_i} = & \left((*) : u_i^{(a_2\alpha_{4,i+1} + \beta_{4,i+1})/w_4} v_i^{(a_2\alpha_{4,i} + \beta_{4,i})/w_4} : u_i^{a_3\beta_{4,i+1}/w_4} v_i^{a_3\beta_{4,i}/w_4} \right. \\ & \left. : -u_i^{(a_2\alpha_{4,i+1} + \beta_{4,i+1})/w_4} v_i^{(a_2\alpha_{4,i} + \beta_{4,i})/w_4} - u_i^{a_3\beta_{4,i+1}/w_4} v_i^{a_3\beta_{4,i}/w_4} + (*) \right), \end{aligned}$$

where $(*)$ are terms in u_i and v_i of degree higher than $(a_2\alpha_{4,i+1} + \beta_{4,i+1} + a_2\alpha_{4,i} + \beta_{4,i})/w_4$ and $(a_3\beta_{4,i+1} + a_3\beta_{4,i})/w_4$.

Assume now that u_i and v_i are both nonzero. If $a_2\alpha_{4,i} - (a_3 - 1)\beta_{4,i} < a_2\alpha_{4,i+1} - (a_3 - 1)\beta_{4,i+1} < 0$, then we can factor out

$$(u_i^{\alpha_{4,i+1}/w_4} v_i^{\alpha_{4,i}/w_4}) a_2 (u_i^{\beta_{4,i+1}/w_4} v_i^{\beta_{4,i}/w_4})$$

from $\psi \circ \sigma$ to obtain

$$\psi \circ \sigma|_{U_i} = ((*) : 1 : u_i^{((a_3-1)\beta_{4,i+1} - a_2\alpha_{4,i+1})/w_4} v_i^{((a_3-1)\beta_{4,i} - a_2\alpha_{4,i})/w_4} : -1 + (*)).$$

Then $(\psi \circ \sigma|_{U_i})(u_i, 0) = (\psi \circ \sigma|_{U_i})(0, v_i) = (0 : 1 : 0 : -1)$. Repeating the same procedure for $0 < a_2\alpha_{4,i} - (a_3 - 1)\beta_{4,i} < a_2\alpha_{4,i+1} - (a_3 - 1)\beta_{4,i+1}$, we obtain that, restricted to that open set U_i ,

$$(\psi \circ \sigma|_{U_i})(u_i, 0) = (\psi \circ \sigma|_{U_i})(0, v_i) = (0 : 0 : 1 : -1).$$

Now we are left with the case $a_2\alpha_{4,i} - (a_3 - 1)\beta_{4,i} \leq 0 \leq a_2\alpha_{4,i+1} - (a_3 - 1)\beta_{4,i+1}$. Suppose first that the curve $\Gamma'_{3,4}$ intersects one component of the exceptional divisor, so Proposition 3.9 implies that there is some j such that $a_2\alpha_{4,j} - (a_3 - 1)\beta_{4,j} = 0$. By Corollary 3.10, $\Gamma'_{3,4}$ intersects the exceptional divisor transversally at one point, so $(a_2\alpha_{4,j+1} - (a_3 - 1)\beta_{4,j+1})/w_4 = 1$, and $(a_2\alpha_{4,j-1} - (a_3 - 1)\beta_{4,j-1})/w_4 = -1$. Then in U_{j-1} we can still factor out

$$(u_i^{\alpha_{4,i+1}/w_4} v_i^{\alpha_{4,i}/w_4}) a_2 (u_i^{\beta_{4,i+1}/w_4} v_i^{\beta_{4,i}/w_4}),$$

so assuming that u_{j-1} and v_{j-1} are not zero, the maps looks like

$$\psi \circ \sigma|_{U_{j-1}} = ((*) : 1 : v_{j-1} : -1 - v_{j-1} + (*)).$$

Therefore, $(\psi \circ \sigma|_{U_{j-1}})(u_{j-1}, 0) = (0 : 1 : 0 : -1)$ and $(\psi \circ \sigma|_{U_{j-1}})(0, v_{j-1}) = (0 : 1 : v_{j-1} : -1 - v_{j-1})$. Doing the same for U_j we find that $(\psi \circ \sigma|_{U_j})(0, v_j) = (0 : 0 : 1 : -1)$ and $(\psi \circ \sigma|_{U_j})(u_j, 0) = (0 : u_j : 1 : -u_j - 1)$. Then we see that $\psi \circ \sigma(\bigcup_{i=0}^{j-1} E_{4,i}) = (0 : 1 : 0 : -1)$ and $\psi \circ \sigma(\bigcup_{i=j+1}^{s_4+1} E_{4,i}) = (0 : 0 : 1 : -1)$. Notice that v_{j-1} and u_j are the coordinates of the charts of $E_j \simeq \mathbb{P}^1$ and that

$$(\psi \circ \sigma|_{U_{j-1}})(0, v_{j-1}) = (0 : 1 : v_{j-1} : -1 - v_{j-1})$$

and

$$(\psi \circ \sigma|_{U_j})(u_j, 0) = (0 : u_j : 1 : -u_j - 1).$$

So $\psi \circ \sigma$ is an isomorphism from E_j onto the line $(y_1 = 0) \subset (y_1 + y_2 + y_3 + y_4 = 0) \subset \mathbb{P}^3_{y_1, y_2, y_3, y_4}$. Therefore, $\psi \circ \sigma$ is defined at the exceptional divisor over p_4 , and it is totally branched over the line $L_1 = (y_1 = 0) \subset (y_1 + y_2 + y_3 + y_4 = 0)$.

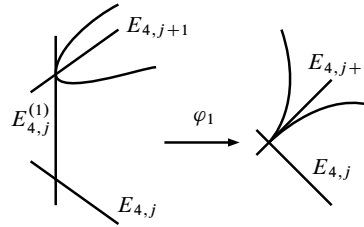

Figure 4. An example of the situation in Proposition 3.12.

Now, if $\Gamma'_{3,4}$ does not intersect transversally the exceptional divisor, then $a_2\alpha_{4,i} - (a_3 - 1)\beta_{4,i} \neq 0$ for all i , so we will have some j such that

$$a_2\alpha_{4,j} - (a_3 - 1)\beta_{4,j} < 0 < a_2\alpha_{4,j+1} - (a_3 - 1)\beta_{4,j+1},$$

and we will not be able to define the map on the open set U_j . This is because we can factor out $u_j^{a_3\beta_{4,j+1}} v_j^{a_2\alpha_{4,j} + \beta_{4,j}}$ from $\psi \circ \sigma|_{U_j}$, so the map will be

$$\begin{aligned} \psi \circ \sigma|_{U_j} = ((*) : u_j^{(a_2\alpha_{4,j+1} - (a_3 - 1)\beta_{4,j+1})/w_4} : v_j^{((a_3 - 1)\beta_{4,j} - a_2\alpha_{4,j})/w_4} \\ : -u_j^{(a_2\alpha_{4,j+1} - (a_3 - 1)\beta_{4,j+1})/w_4} - v_j^{((a_3 - 1)\beta_{4,j} - a_2\alpha_{4,j})/w_4} + (*)). \end{aligned}$$

Then if $v_j \neq 0$, $(\psi \circ \sigma|_{U_j})(0, v_j) = (0 : 0 : 1 : -1)$, and if $u_j \neq 0$, we have $(\psi \circ \sigma|_{U_j})(u_j, 0) = (0 : 1 : 0 : -1)$, and so it is not well defined when $u_j = v_j = 0$. □

Proposition 3.12. *Assume that $\Gamma'_{3,4}$ does not intersect transversally the exceptional divisor, so it intersects it at the point $(0, 0)$ of some affine open set U_j . Let $\varphi_1 : X_1 \rightarrow \tilde{X}$ be the blowup over that point, let $E_{4,j}^{(1)}$ be the new component of the exceptional divisor, and let $u_j, v'_{j,1}$ and $u'_{j,1}, v_j$ be the affine coordinates of $U_j^{(1,1)}$ and $U_j^{(1,2)}$, the two affine charts over U_j . Then they satisfy the relations $x_2^{w_4} = u_j^{\alpha_{4,j} + \alpha_{4,j+1}} v'_{j,1}{}^{\alpha_{4,j}} = u'_{j,1}{}^{\alpha_{4,j+1}} v_j^{\alpha_{4,j} + \alpha_{4,j+1}}$ and $x_3^{w_4} = u_j^{\beta_{4,j} + \beta_{4,j+1}} v'_{j,1}{}^{\beta_{4,j}} = u'_{j,1}{}^{\beta_{4,j+1}} v_j^{\beta_{4,j} + \beta_{4,j+1}}$.*

Proof. This follows from the fact that the resolution was constructed as a toric variety, and the blowup of an affine variety defined by vectors v_1 and v_2 is the variety associated to the fan generated by the vectors $v_1, v_1 + v_2$, and v_2 . (Figure 4 shows an example of the situation in the proposition.) □

Notice that, if $a_2\alpha_{4,j} - (a_3 - 1)\beta_{4,j} < 0 < a_2\alpha_{4,j+1} - (a_3 - 1)\beta_{4,j+1}$, then

$$a_2\alpha_{4,j} - (a_3 - 1)\beta_{4,j} < a_2(\alpha_{4,j} + \alpha_{4,j+1}) - (a_3 - 1)(\beta_{4,j} + \beta_{4,j+1})$$

and

$$a_2(\alpha_{4,j} + \alpha_{4,j+1}) - (a_3 - 1)(\beta_{4,j} + \beta_{4,j+1}) < a_2\alpha_{4,j+1} - (a_3 - 1)\beta_{4,j+1},$$

so we can use Proposition 3.8 to see that the strict transform of $\Gamma'_{3,4}$ in the blowup intersects at most two components of the exceptional divisor, and that the singularity of the curve is “better”. Therefore, the map $\psi \circ \sigma \circ \varphi_1$ is defined in one of the charts $U_j^{(1,i)}$, and if $a_2(\alpha_{4,j} + \alpha_{4,j+1}) - (a_3 - 1)(\beta_{4,j} + \beta_{4,j+1}) = 0$, then it is defined in all the exceptional divisor on X_1 over p_4 .

Proof of Theorem 3.7. If all the curves $\Gamma'_{i,i+1}$ intersect transversally the exceptional divisor on \tilde{X} , then the result follows from Theorem 3.11. If not, then consider the log resolution $\varphi : \hat{X} \rightarrow X$ of all the curves $\Gamma'_{i,i+1}$. Proposition 3.12 shows that the relations of the new local coordinates are compatible with the previous ones, and as the strict transform of the curves $\Gamma'_{i,i+1}$ intersect transversally the exceptional divisor, we can use the proof of Theorem 3.11 to show that the composition $\psi \circ \sigma \circ \varphi$ is defined over \hat{X} . \square

Corollary 3.13. *The morphisms $\psi \circ \sigma \circ \varphi : \hat{X} \rightarrow \mathbb{P}^2$ and $Y' \rightarrow \mathbb{P}^2$ (defined at the end of Section 2) factor through a birational morphism $\hat{X} \rightarrow Y'$ which contracts precisely six chains of smooth rational curves in*

$$(\sigma \circ \varphi)^*(C_1 + C_2 + \Gamma_{1,2} + \Gamma_{2,3} + \Gamma_{3,4} + \Gamma_{4,1}),$$

each containing one of the proper transforms of $C_1, C_2, \Gamma_{1,2}, \Gamma_{2,3}, \Gamma_{3,4}, \Gamma_{4,1}$, and each contracting to the six cyclic quotient singularities in Y' .

Proof. First, by Theorem 3.7, we note that $\psi \circ \sigma \circ \varphi : \hat{X} \rightarrow \mathbb{P}^2$ contracts precisely six chains of smooth rational curves in $(\sigma \circ \varphi)^*(C_1 + C_2 + \Gamma_{1,2} + \Gamma_{2,3} + \Gamma_{3,4} + \Gamma_{4,1})$, each containing one of the proper transforms of $C_1, C_2, \Gamma_{1,2}, \Gamma_{2,3}, \Gamma_{3,4}, \Gamma_{4,1}$. This was done locally when we proved the definition of the map in Theorem 3.11 at a certain exceptional component over the p_i . Each of these components maps to each of the four lines in \mathbb{P}^2 . Therefore, the birational map $\hat{X} \dashrightarrow Y'$ is defined over these components except possibly over the six singularities of Y' . Because there is a unique minimal resolution for normal two-dimensional singularities, the six chains of curves in \hat{X} mapping to the six nodes of the four lines in \mathbb{P}^2 must contract to the six singularities of Y' . \square

4. Kollár surfaces are Hwang–Keum surfaces

We now study the case $w^* = 1$. In this section, we allow $\gcd(w_1, w_3)$ and $\gcd(w_2, w_4)$ to be greater than 1.

In [Kollár 2008, p. 231], it is shown that the curves C_1 and C_2 are extremal rays of the $K_{X(a_1, a_2, a_3, a_4)} + (1 - \epsilon)(C_1 + C_2)$ minimal model program if $C_1^2 < 0$ and $C_2^2 < 0$. They are both contractible to quotient singularities. Hwang and Keum [2012] computed explicitly the type of these singularities.

Theorem 4.1 [Hwang and Keum 2012, Theorem 1.1]. *The contraction of the curve C_1 forms a singularity of type $\frac{1}{s_1}(w_2, w_4)$, with $s_1 = a_4 w_4 - w_3$, and the contraction of the curve C_2 forms a singularity of type $\frac{1}{s_2}(w_1, w_3)$, with $s_2 = a_3 w_3 - w_2$. If $w^* = 1$, then their Hirzebruch–Jung continued fractions are*

$$\underbrace{[2, \dots, 2, a_3, a_1, 2, \dots, 2]}_{a_4-1} \quad \text{and} \quad \underbrace{[2, \dots, 2, a_2, a_4, 2, \dots, 2]}_{a_3-1},$$

respectively.

Let $\eta : X(a_1, a_2, a_3, a_4) \rightarrow X'(a_1, a_2, a_3, a_4)$ be the contraction of C_1 and C_2 . Hwang and Keum [2012, §4] constructed several examples of rational \mathbb{Q} -homology projective planes with two cyclic singularities. In certain cases the singularities are the same as for $X'(a_1, a_2, a_3, a_4)$ when $w^* = 1$.

The construction of Hwang–Keum is as follows. Let L_1, L_2, L_3, L_4 be four general lines in \mathbb{P}^2 , and choose four points from the six intersection points, such that every L_i passes through two of them. After

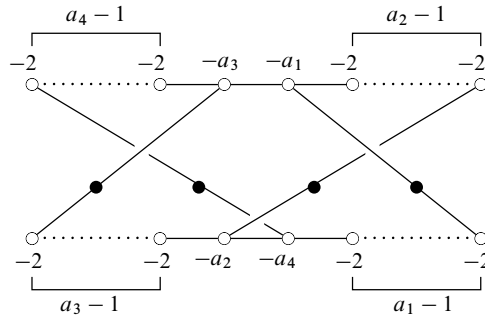
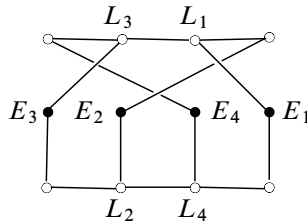

Figure 5. Curve configuration over $Z(a_1, a_2, a_3, a_4)$.

blowing up each of these four points twice, we obtain the curve configuration



where \bullet is a (-1) -curve and \circ is a (-2) -curve. We now blowup r_i times the point $E_i \cap L_i$ to obtain the surface $Z(a_1, a_2, a_3, a_4)$, where $a_i = 2 + r_i$. The curve configuration on $Z(a_1, a_2, a_3, a_4)$ is shown in Figure 5.

Let $T(a_1, a_2, a_3, a_4)$ be the surface obtained by contracting the two chains of rational curves corresponding to the white vertices. Then this surface is a rational \mathbb{Q} -homology projective plane with two cyclic singularities. By Theorem 4.1, it has the same singularities as $X'(a_1, a_2, a_3, a_4)$ when $w^* = 1$.

Theorem 4.2. *Let $X(a_1, a_2, a_3, a_4)$ be a Kollár surface with $w^* = 1$, and assume that $a_i \geq 2$ for all i . Then $X'(a_1, a_2, a_3, a_4)$ is the Hwang–Keum surface $T(a_1, a_2, a_3, a_4)$.*

To prove Theorem 4.2 we will show that we can find the same curve configuration of $Z(a_1, a_2, a_3, a_4)$ (Figure 5) in \tilde{X}' , which is the minimal resolution of $X'(a_1, a_2, a_3, a_4)$.

First of all, we prove that the rational map ψ is defined in the minimal resolution of X . For this we will use:

Proposition 4.3. *Let X be a surface with a cyclic quotient singularity at the point p , and let $C \subset X$ be a curve passing through p . Then C is nonsingular at p if and only if the strict transform of C intersects transversally at one point only one component of the exceptional divisor of the minimal resolution of X .*

Proof. The maximal cycle (which coincides with the fundamental cycle) of a cyclic quotient singularity is the (reduced) exceptional divisor. Then we can apply [Gonzalez-Sprinberg and Lejeune-Jalabert 1997, Proposition 1.1]. □

By Proposition 3.3 we have that the curves $\Gamma_{i,i+1}$ are smooth, so Proposition 4.3 says that the curves $\Gamma'_{i,i+1}$ intersect transversally the exceptional divisor over p_{i+1} . If $\gcd(w_1, w_3) = \gcd(w_2, w_4) = 1$, then we already know that the map ψ is defined on the minimal resolution of X . Therefore, we only need to check the same assertion when $\gcd(w_1, w_3) > 1$ or $\gcd(w_2, w_4) > 1$.

Proposition 4.4. *The map $\psi \circ \sigma : \tilde{X} \rightarrow \mathbb{P}^2$ is a morphism.*

Proof. We study the case over the point p_4 , with $\gcd(w_2, w_4) = h > 1$. The singularity at p_4 is $1/w_4(w_2, w_3)$ with toric coordinates x_2 and x_3 . From Proposition 3.1 we have that $1/w_4(w_2, w_3) \simeq 1/t_4(t_2, w_3)$, with toric coordinates x'_2 and x'_3 , and the relation $x'_2 = x_2$ and $x'_3 = x_3^h$. Then from Theorem 3.6 we have $Y = U_1 \cup \dots \cup U_{s_4}$ in the resolution of p_4 , with u_i, v_i the local coordinates in U_i , and the relations $x_2^{t_4} = u_i^{\alpha_{4,i}} v_i^{\alpha_{4,i+1}}$ and $x_3^{t_4} = u_i^{\beta_i} v_i^{\beta_{i+1}}$. The curve $\Gamma_{3,4} \subset \mathbb{P}(t_2, w_3, t_4)$, restricted to the open set $(x_4 = 1)$, has equation $x_2^{a_2} + x_3^{(a_3-1)/h} = 0$, and we can use Proposition 3.8 to find the equation of the curve in every U_i .

Following the proof of Proposition 3.9, by the intersection number

$$\Gamma'_{3,4} \cdot \sum_{i=0}^{s_4+1} \frac{\beta_{4,i}}{t_4} E_{4,i} = \frac{a_2}{t_4},$$

and using the fact that the curve $\Gamma'_{3,4}$ intersects transversally one component, we have that there exist $\beta_{4,j} = a_2$ and $\alpha_{4,j} = (a_3 - 1)/h$. Therefore,

$$\begin{aligned} a_2 \alpha_{4,j-1} - \frac{a_3 - 1}{h} \beta_{4,j-1} &= -1, \\ a_2 \alpha_{4,j} - \frac{a_3 - 1}{h} \beta_{4,j} &= 0, \\ a_2 \alpha_{4,j+1} - \frac{a_3 - 1}{h} \beta_{4,j+1} &= 1. \end{aligned}$$

Hence, considering the composition

$$\tilde{X} \xrightarrow{\sigma} \frac{1}{t_4}(t_2, w_3) \xrightarrow{\simeq} \frac{1}{w_4}(w_2, w_3) \xrightarrow{-\psi} X(a_1, a_2, a_3, a_4)$$

we have the hypothesis of Theorem 3.11; therefore, the map is defined on the whole exceptional divisor. \square

Proposition 4.5. *The curves C'_1 and C'_2 in \tilde{X} are (-1) -curves. To obtain the chain of curves*

$$K_1 := E_{2,s_2} \cup \dots \cup E_{2,1} \cup C'_1 \cup E_{4,1} \cup \dots \cup E_{4,s_4}$$

and

$$K_2 := E_{1,s_1} \cup \dots \cup E_{1,1} \cup C'_2 \cup E_{3,1} \cup \dots \cup E_{3,s_3}$$

we blowup \tilde{X}' on the intersection points of the curves with self-intersections $-a_3$ and $-a_1$, and $-a_2$ and $-a_4$, respectively.

Proof. We have the commutative diagram

$$\begin{array}{ccc} \tilde{X} & \xrightarrow{\sigma} & X(a_1, a_2, a_3, a_4) \\ \downarrow & & \downarrow \eta \\ \tilde{X}' & \xrightarrow{\sigma'} & X'(a_1, a_2, a_3, a_4) \end{array}$$

Then, to obtain the chain of curves K_1 we have to blowup on the exceptional divisor over the singularity $\frac{1}{s_1}(w_2, w_4)$. This is because, if no blowup were needed, then C'_1 would be some of the curves in the exceptional divisor over the singularity $\frac{1}{s_1}(w_2, w_4)$, so we would have that $w_2 \leq a_4 - 1$ or $w_4 \leq a_2 - 1$, which can happen only if one of the a_i is 1. Recall from Theorem 4.1 that the Hirzebruch–Jung continued fraction of the singularity $\frac{1}{s_1}(w_2, w_4)$ is $[2, \dots, 2, a_3, a_1, 2, \dots, 2]$. Then we want to show that the blowups needed must be done between the curves with self-intersection $-a_3$ and $-a_1$. For this, we will rule out every other possibility. Suppose first that the blowups are done on the point

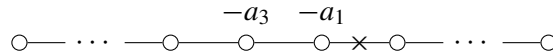

Then we would obtain that the continued fraction associated to the singularity at p_2 would have an β_i such that

$$\beta_i \geq |[2, \dots, 2, a_3, a_1 + 1]|,$$

$\underbrace{\hspace{10em}}_{a_4-1}$

but $|\overbrace{[2, \dots, 2]}^{a_4-1}, a_3, a_1 + 1| = w_2 + 2 + a_3a_4 - 2a_4 > w_2$, which is a contradiction. If the blowups are done on the point

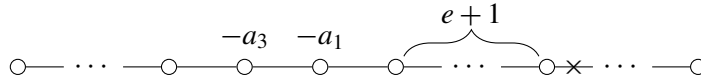

with $e \geq 0$, we would have

$$\beta_i \geq |[2, \dots, 2, a_3, a_1, \underbrace{2, \dots, 2}_e, 3]|,$$

$\underbrace{\hspace{10em}}_{a_4-1}$

but $|\overbrace{[2, \dots, 2]}^{a_4-1}, a_3, a_1, \overbrace{2, \dots, 2}^e, 3| = (2e + 3)w_2 - (2e + 1)a_3a_4 - 2a_4 + 1 > w_2$.

Therefore, the blowups to obtain the chain of curves K_1 desired have to be done at the point

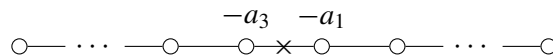

□

From the proof of Proposition 4.5, we have that the singularity at p_i of the Kollár surface has Hirzebruch–Jung continued fraction

$$[\dots, c_i, \underbrace{2, \dots, 2}_{a_{i+2}-1}]$$

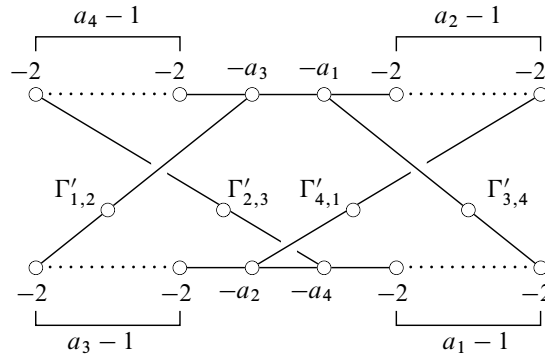

Figure 6. Curve configuration on \tilde{X}' .

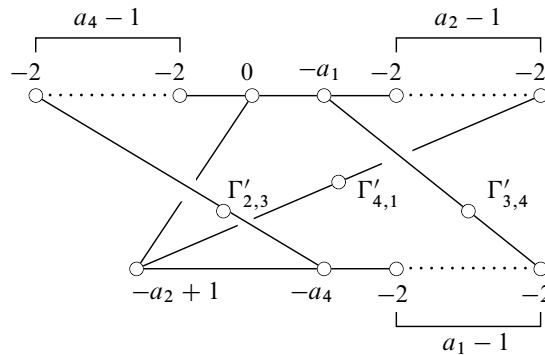

Figure 7. Contraction of $\Gamma'_{1,2}$ and the chain of (-2) -curves.

with $c_i > 2$. The intersection of $\Gamma'_{i-1,i}$ with the exceptional divisor over p_i is $\beta_{i,j}/w_i = a_{i+2}/w_i$, so the curve $\Gamma'_{i-1,i}$ intersects the exceptional divisor over p_i at the mentioned component with self-intersection $-c_i$. This is because $\beta_{i,s_i+1} = 0$ and $\beta_{i,s_i} = 1$, and $\beta_{i,k-1} = b_k \beta_{i,k} - \beta_{i,k+1}$. This implies that $\beta_{i,s_i-(a_2-1)} = a_2 = \beta_j$. Therefore, we have the curve configuration shown in Figure 6.

Proposition 4.6. *The curves $\Gamma'_{i,i+1}$ are (-1) -curves.*

Proof. We have a birational morphism $\psi \circ \sigma : \tilde{X} \rightarrow \mathbb{P}^2$, so it is a composition of blowups, which contracts (-1) -curves to reach \mathbb{P}^2 . We start by contracting the curves from the proof of Proposition 4.5 to obtain \tilde{X}' with the curve configuration in Figure 6. Recall from Theorem 3.11 that the image of the curves with self-intersection $-a_i$ are the four lines in general position in \mathbb{P}^2 , so they cannot be contracted. In addition, by Corollary 3.13 the birational morphism $\tilde{X}' \rightarrow \mathbb{P}^2$ is an isomorphism outside of the configuration in Figure 6. Then, one of the $\Gamma'_{i,i+1}$ is a (-1) -curve; say that it is $\Gamma'_{1,2}$. We contract $\Gamma'_{1,2}$ and the chain of (-2) -curves connected to it, to obtain the diagram in Figure 7.

By repeating the procedure, we obtain that all curves $\Gamma'_{i,i+1}$ are (-1) -curves. □

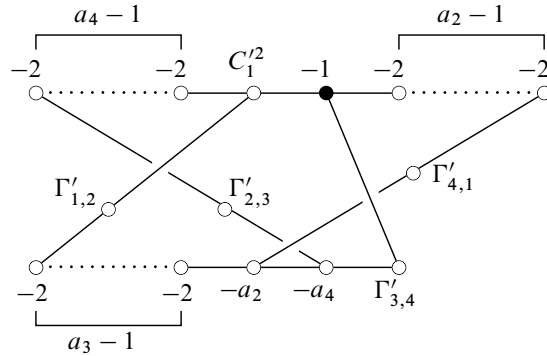

Figure 8. Curve configuration on \widehat{X}' .

Proof of Theorem 4.2. From Propositions 4.5 and 4.6, we conclude that \widetilde{X}' and $Z(a_1, a_2, a_3, a_4)$ are obtained from the same sequence of blowups of \mathbb{P}^2 . Therefore, $\widetilde{X}' \simeq Z(a_1, a_2, a_3, a_4)$ and so $X'(a_1, a_2, a_3, a_4) \simeq T(a_1, a_2, a_3, a_4)$. □

Remark 4.7. We note that, if $w^* \neq 1$, then the surface $T(a_1, a_2, a_3, a_4)$ does not correspond to a Kollár surface, so Kollár surfaces with $w^* = 1$ and $a_i \geq 2$ are strictly contained in Hwang–Keum surfaces.

Finally, we check what happens when some $a_i = 1$, say $a_1 = 1$.

Corollary 4.8. *Let $a_1 = 1$. Then the point p_4 is smooth, and the map ψ is defined in the log resolution \widehat{X} of the key curves. The curve $\Gamma_{3,4}$ is smooth, and ψ does not contract C_1 . The surface \widehat{X} is obtained by doing blowups from $Z(1, a_2, a_3, a_4)$. The curve $C_1 \subset X(1, a_2, a_3, a_4)$ is contractible if and only if $a_3 > a_2$.*

Proof. If $a_1 = 1$, then $w_2 = a_4(a_3 - 1)$ and $w_4 = a_3 - 1$. Then by Proposition 3.1 we have that the point p_4 is smooth, and at the point p_2 the singularity is of type $\frac{1}{a_4}(1, a_2a_3a_4 - a_3a_4 + a_4 - 1) = \frac{1}{a_4}(1, a_4 - 1)$. The curve $\Gamma_{1,2}$ intersects transversally the curve C_1 at the point $(0 : -1 : 0 : 1)$, and following the proof of Proposition 3.4 we have that $\psi(0 : 1 : 0 : b) = (b : -1 - b : 0 : 1)$, so the curve ψ does not contract C_1 . The curve $\Gamma_{3,4}$ restricted to the weighted projective plane $(x_1 = 0)$ and to the open set $(x_4 \neq 1)$ is $(x_2^{a_2} + x_3 = 0) \subset \mathbb{A}^2$, so it is smooth and to obtain the log resolution \widehat{X} it is necessary to do a_2 blowups.

Now assume that all the other $a_i \geq 2$. Therefore, C_2 is contractible, and by contracting it and all the other (-1) -curves in \widehat{X} we obtain the surface \widehat{X}' with the curve configuration shown in Figure 8. If also $a_2 = 1$, then all the points are smooth but point p_2 with a singularity of type $\frac{1}{a_4}(1, a_4 - 1)$, and we obtain the curve configuration on \widehat{X} shown in Figure 9.

Following the proof of Proposition 4.6 we have that the curves $\Gamma'_{i,i+1}$ are (-1) -curves, $C_1^{l_2} = -a_3$, and $C_2^{l_2} = -a_4$. Therefore, $\widehat{X}' \simeq Z(1, a_2, a_3, a_4)$, and by contracting the (-1) -curve in the top chain along with the (-2) -curves to the right, we obtain that $C_1^{l_2} = -a_3 + a_2$. Therefore, C_2 is contractible if and only if $C_1^{l_2} < 0$, and this is equivalent to $a_3 > a_2$. □

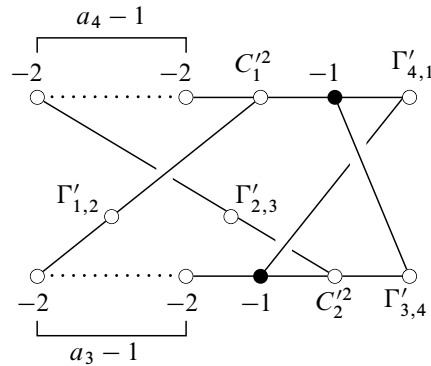

Figure 9. Curve configuration on X'_n when $a_2 = 1$.

5. Kollár surfaces as branched covers of \mathbb{P}^2

We now consider the birational model $Y' := \text{Spec}_{\mathbb{P}^2}(\bigoplus_{i=0}^{w^*-1} \mathcal{L}^{(i)-1})$ of $X(a_1, a_2, a_3, a_4)$, which was defined at the end of Section 2 as the w^* -th root cover of $(L_1^{\mu_1} L_2^{\mu_2} L_3^{\mu_3} L_4^{\mu_4} = 0) \subset \mathbb{P}^2$. We recall that $0 < \mu_i < w^*$ are

$$\mu_1 \equiv a_2 a_3 a_4, \quad \mu_2 \equiv -a_3 a_4, \quad \mu_3 \equiv a_4, \quad \mu_4 \equiv -1$$

modulo w^* , and that by definition $\gcd(\mu_i, w^*) = 1$. The lines L_1, L_2, L_3, L_4 form a plane curve with six nodes. We also recall that

$$\mathcal{L}^{(i)} := \mathcal{O}_{\mathbb{P}^2}(w_1 i) \otimes \mathcal{O}_{\mathbb{P}^2} \left(- \sum_{j=1}^4 \left[\frac{\mu_j i}{w^*} \right] L_j \right)$$

for $i \in \{0, 1, \dots, w^* - 1\}$, where $[x]$ is the integer part of x , and $w_1 w^* = \sum_{i=1}^4 \mu_i$. Let Y be the minimal resolution of all singularities in Y' .

Theorem 5.1. *The Kollár surface $X(a_1, a_2, a_3, a_4)$ is birational to*

$$X(a'_1, a'_2, a'_3, a'_4) \subset \mathbb{P}(w'_1, w'_2, w'_3, w'_4)$$

with $\gcd(w'_1, w'_3) = \gcd(w'_2, w'_4) = 1$, for infinitely many 4-tuples (a'_1, a'_2, a'_3, a'_4) .

Proof. By Corollary 2.4, the surface $X(a_1, a_2, a_3, a_4)$ is birational to Y' , and so for any $t_i \in \mathbb{Z}_{\geq 0}$ we have that $X(a_1, a_2, a_3, a_4)$ is birational to

$$X(a_1 + t_1 w^*, a_2 + t_2 w^*, a_3 + t_3 w^*, a_4 + t_4 w^*),$$

as soon as $w^* = \gcd(W'_1, \dots, W'_4)$ for the corresponding W'_i . This is because, for a fixed w^* , the isomorphism type of Y' depends only on the multiplicities μ_i modulo w^* . In this way, we must find $t_i \in \mathbb{Z}_{\geq 0}$ such that $\gcd(w'_1, w'_3) = \gcd(w'_2, w'_4) = 1$, and $w^* = \gcd(W'_1, \dots, W'_4)$.

First, choose t_3 such that $\gcd(a_3 + t_3 w^*, 6(a_4 - 1)) = 1$, and let $a'_3 := a_3 + t_3 w^*$ and $W'_1 := a_2 a'_3 a_4 - a'_3 a_4 + a_4 - 1 = w'_1 w^*$. Next take t_2 such that $\gcd(w'_1 + t_2 a'_3 a_4, 6(a_4 - 1)) = 1$, and then

define $a'_2 := a_2 + t_2 w^*$. Now we will choose t_1 such that the final weights $(w''_1, w''_2, w''_3, w''_4)$ satisfy $\gcd(w''_1, w''_3) = \gcd(w''_2, w''_4) = 1$, and $w^* = \gcd(W''_1, \dots, W''_4)$.

Let $W''_2 := a'_3 a_4 a_1 - a_4 a_1 + a_1 - 1 = w'_2 w^*$, $W''_3 := a_4 a_1 a'_2 - a_1 a'_2 + a'_2 - 1 = w'_3 w^*$, and $W''_4 := a_1 a'_2 a'_3 - a'_2 a'_3 + a'_3 - 1 = w'_4 w^*$, and define

$$\begin{aligned} W''_1 &:= w''_1 w^* = w'_1 w^*, & W''_2 &:= w''_2 w^* = (w'_2 + t(a'_3 a_4 - a_4 + 1)) w^*, \\ W''_3 &:= w''_3 w^* = (w'_3 + t(a_4 a'_2 - a'_2)) w^*, & W''_4 &:= w''_4 w^* = (w'_4 + t a'_2 a'_3) w^*, \end{aligned}$$

where t will be found.

Let $w''_1 = \prod q_{1,j}^{\lambda_{1,j}}$ be its prime factorization. Then we have to find a solution t for $w'_4 + t a'_2 a'_3 \not\equiv 0 \pmod{q_{1,j}}$, $w'_3 + t a'_2 (a_4 - 1) \not\equiv 0 \pmod{q_{1,j}}$, and $t \not\equiv 0 \pmod{q_{1,j}}$, for all j . This t will exist because we have that $\gcd(a_4 - 1, w''_1) = 1$, and that all $p_{1,j}$ are greater than 3, by the previous choice of t_2 and t_3 .

By the Chinese remainder theorem, we know that the solutions are of the form $t_1 + r \cdot \prod q_{1,j}$, $r \in \mathbb{Z}$. Hence, we have that $\gcd(w''_1, w''_3) = \gcd(w''_1, w''_4) = 1$, for any choice of r . Therefore, considering

$$w''_2 = w'_2 + t_1(a'_3 a_4 - a_4 + 1) + r \cdot (a'_3 a_4 - a_4 + 1) \cdot \prod q_{1,j}$$

and $w''_4 = w'_4 + t_1 a'_2 a'_3 + r \cdot a'_2 a'_3 \cdot \prod q_{1,j}$, it is enough to find an $r \in \mathbb{Z}_{\geq 0}$ such that $\gcd(w''_2, w''_4) = 1$. Let

$$\begin{aligned} A &:= w'_2 + t_1(a'_3 a_4 - a_4 + 1), & B &:= (a'_3 a_4 - a_4 + 1) \cdot \prod q_{1,j}, \\ C &:= w'_4 + t_1 a'_2 a'_3, & D &:= a'_2 a'_3 \cdot \prod q_{1,j}. \end{aligned}$$

Notice that $\gcd(A, B) = 1$ by the definition of w'_2 and the way t_1 was obtained. Let $AD - BC = q_{2,1}^{\lambda_{2,1}} q_{2,2}^{\lambda_{2,2}} \cdots q_{2,l}^{\lambda_{2,l}}$ with $q_{2,j}$ a prime number, and let r_1 be a solution of

$$A + Br \not\equiv 0 \pmod{q_{2,j}}. \tag{5-1}$$

Now assume that $\gcd(w''_2, w''_4) = \gcd(A + Br_1, C + Dr_1) > 1$. This means that there is a prime $p \neq q_{2,j}$ for all j , such that it divides both $A + Br$ and $C + Dr$. Then consider the linear transformation $T : (\mathbb{Z}/p\mathbb{Z})^2 \rightarrow (\mathbb{Z}/p\mathbb{Z})^2$ associated to the matrix $\begin{pmatrix} A & B \\ C & D \end{pmatrix}$. This matrix maps the vector $(1, r_1)$ to $(0, 0)$, so the matrix is singular. But the determinant $AD - BC \not\equiv 0 \pmod{p}$, which is a contradiction. Therefore, $\gcd(A + Br_1, C + Dr_1) = 1$. Let $a'_1 := a_1 + (t_1 + r_1 \cdot \prod p_{1,j}) w^*$. This gives us that $X(a'_1, a'_2, a'_3, a_4) \subset \mathbb{P}(w''_1, w''_2, w''_3, w''_4)$ is birational to $X(a_1, a_2, a_3, a_4)$, with $\gcd(w''_1, w''_3) = \gcd(w''_2, w''_4)$, and because $\gcd(w''_1, w''_4) = 1$, then $w^* = \gcd(W''_1, \dots, W''_4)$. Because (5-1) has infinite solutions, then we have infinite 4-tuples $(a''_1, a''_2, a''_3, a''_4)$ that satisfy the result. \square

Corollary 5.2. *Let Y' be an n -th root cover of $(L_1^{\mu_1} L_2^{\mu_2} L_3^{\mu_3} L_4^{\mu_4} = 0) \subset \mathbb{P}^2$, with $\gcd(\mu_i, n) = 1$ for all i . Then Y' is birational to a Kollár surface.*

Proof. If we multiply the μ_i by a unit ξ of $\mathbb{Z}/n\mathbb{Z}$, then the n -th root cover does not change. So we take ξ such that $\xi \mu_4 = -1$. In this way, we have to solve the system $a_2 a_3 a_4 \equiv \xi \mu_1$, $-a_3 a_4 \equiv \xi \mu_2$, $a_4 \equiv \xi \mu_3$, and $a_1 a_2 a_3 a_4 \equiv 1$ modulo n , which has a solution because ξ and the μ_i are units in $\mathbb{Z}/n\mathbb{Z}$. Then, with

those a_i we can use Theorem 5.1 to find numbers a'_i such that $X(a'_1, a'_2, a'_3, a'_4)$ is a Kollár surface with $w^* = n$, and birational to Y' . □

We want to compute the main numerical invariants of Y . For that we first define the following numbers.

Definition 5.3. Let $n > 1$ be an integer, and let a, b be integers coprime to n .

(1) We define the generalized Dedekind sum [Hirzebruch and Zagier 1974, p. 94] as

$$s(a, b; n) = \sum_{i=1}^{n-1} \left(\left(\frac{ia}{n} \right) \right) \left(\left(\frac{ib}{n} \right) \right)$$

where $((x)) = x - [x] - \frac{1}{2}$ for any rational number x .

(2) Let $0 < q < n$ be such that $aq \equiv b$ modulo n . We define the HJ length $l = l(a, b; n)$ as the length of the Hirzebruch–Jung continued fraction

$$\frac{n}{q} = [b_1, \dots, b_l].$$

Dedekind sums and Hirzebruch–Jung continued fractions relate as (see, e.g., [Barkan 1977; Urzúa 2010, Example 3.5])

$$12s(a, b; n) = \frac{q + q^{-1}}{n} + \sum_{i=1}^{l(a,b;n)} (b_i - 3),$$

where $0 < q^{-1} < n$ and $qq^{-1} \equiv 1$ modulo n . We recall that Y is the minimal resolution of Y' .

Proposition 5.4. *We have that $\pi_1(Y) = 0$, and*

$$p_g(Y) = 2s(1, 1; w^*) + \sum_{i < j} s(\mu_i, \mu_j; w^*)$$

where $s(1, 1; w^*) = w^*/12 + 1/(6w^*) - \frac{1}{4}$.

Proof. The finite morphism $Y' \rightarrow \mathbb{P}^2$ is completely ramified at four lines. By pulling back to Y a trivial pencil through one point in one of these lines, one can compute $\pi_1(Y) = 0$; for details see the proof of [Urzúa 2010, Theorem 8.5]. This also shows that $\chi(\mathbb{C}_Y) = 1 + p_g(Y)$. Then we use [Urzúa 2010, Proposition 3.2] to find the formula for $p_g(Y)$. The term $2s(1, 1; w^*)$ turns out to be exactly the expression not involving Dedekind sums in [Urzúa 2010, Proposition 3.2]. □

Remark 5.5. Since the geometric genus $p_g(Y)$ is a nonnegative number, we have $2s(1, 1; w^*) + \sum_{i < j} s(\mu_i, \mu_j; w^*) \geq 0$, which can be rewritten using basic properties of Dedekind sums as

$$p_g(Y) = 2s(1, 1; w^*) - \sum_{i=1}^4 s(1, a_i; w^*) + s(1, a_1a_4; w^*) + s(1, a_1a_2; w^*) \geq 0.$$

We will tell more on this expression in the next section.

Proposition 5.6. *We have that $e(Y) = w^* + 2 + \sum_{i < j} l(\mu_i, \mu_j; w^*)$, and*

$$K_Y^2 = w^* + \frac{4}{w^*} + 4 + \sum_{i < j} (12s(\mu_i, \mu_j; w^*) - l(\mu_i, \mu_j; w^*)).$$

Proof. See [Urzúa 2010, Proposition 3.6], and use Noether’s formula. □

Corollary 5.7. *For $X = X(a_1, a_2, a_3, a_4)$ we have $e(X) = w^* + 4$, $\pi_1(X) = 0$, and $p_g(X) = 2s(1, 1; w^*) - \sum_{i=1}^4 s(1, a_i; w^*) + s(1, a_1a_4; w^*) + s(1, a_1a_2; w^*)$.*

Corollary 5.8. *Let $\gcd(w_i, w_{i+2}) = 1$ for all i . Then*

$$12 \left(\sum_{i < j} s(\mu_i, \mu_j; w^*) + \sum_i s(w_{i+2}, w_{i+3}; w_i) \right) = \frac{d(d - \sum_i w_i)^2}{\prod_i w_i} - \sum_i \frac{2}{w_i} - \frac{w^{*2} - 6w^* + 4}{w^*}.$$

Proof. Let $X = X(a_1, a_2, a_3, a_4)$. We are going to compute $p_g(X)$ from its minimal resolution, and then the equality follows from $p_g(X) = p_g(Y)$. Let $\tilde{X} \rightarrow X$ be the minimal resolution of singularities, so $p_g(\tilde{X}) = p_g(X)$. As in the proof of Proposition 3.4 in [Urzúa 2010] and the formula right before Proposition 5.4, we have

$$K_{\tilde{X}}^2 - K_X^2 = -12 \sum_i s(w_{i+2}, w_{i+3}; w_i) - \sum_i l(w_{i+2}, w_{i+3}; w_i) + \sum_i \frac{2(w_i - 1)}{w_i},$$

and $e(\tilde{X}) - e(X) = \sum_i l(w_{i+2}, w_{i+3}; w_i)$. Since $K_X^2 = d(d - \sum_i w_i)^2 / \prod_i w_i$ and $e(X) = w^* + 4$, then

$$p_g(\tilde{X}) = \frac{d(d - \sum_{i=1}^4 w_i)^2}{12w_1w_2w_3w_4} - \sum_i s(w_{i+2}, w_{i+3}; w_i) - \frac{1}{6} \sum_i \frac{1}{w_i} + \frac{w^*}{12}$$

is a consequence of the Noether’s equality $12\chi(\mathcal{O}_{\tilde{X}}) = K_X^2 + e(\tilde{X})$. □

6. Theorems on geometric genus

In this section we prove results related to the geometric genus of Kollár surfaces. All our computations will be done in terms of generalized Dedekind sums. We note that the (classical) Dedekind sum $s(q, n)$ is equal to $s(1, q; n)$ and $s(a, b; n) = s(1, a^{-1}b; n)$, and so all properties of $s(q, n)$ are properties of $s(a, b; n)$ [Hirzebruch and Zagier 1974, Chapter II]. For example, we have the reciprocity law:

Theorem 6.1 (see, e.g., [Hirzebruch and Zagier 1974, p. 93]). *If n and k are relatively prime, then*

$$s(1, k; n) + s(1, n; k) = \frac{1}{12} \left(\frac{n}{k} + \frac{1}{nk} + \frac{k}{n} \right) - \frac{1}{4}. \tag{6-1}$$

Throughout this section, w^* will be greater than 1. All equalities involving \equiv will be modulo w^* , unless otherwise stated. The symbol q^{-1} will denote the inverse of q modulo w^* . To avoid confusion, we will write $\frac{1}{q}$ when it corresponds to a number in \mathbb{Q} .

Proposition 6.2. *Any $n \geq 0$ is realizable as the geometric genus of a Kollár surface.*

Proof. We know that $w^* = 1$ implies rationality, and so $p_g = 0$. Assume that $n > 0$, and let $w^* = 3n + 1$ and $a_1 \equiv 3^{-1}$, $a_2 \equiv 3$, and $a_3 \equiv a_4 \equiv w^* - 1$. This gives the w^* -th root cover Y with $\mu_1 = 3$ and $\mu_2 = \mu_3 = \mu_4 = w^* - 1$. The geometric genus of Y is

$$\begin{aligned} p_g(Y) &= 5s(1, 1; w^*) - 3s(1, 3; w^*) \\ &= 5\left(\frac{w^*}{12} + \frac{1}{6w^*} - \frac{1}{4}\right) - 3\left(\frac{w^*}{36} + \frac{1}{4w^*} + \frac{1}{36w^*} - \frac{1}{18} - \frac{1}{4}\right) \\ &= n. \end{aligned} \quad \square$$

6.1. $p_g = 0$ surfaces are rational.

Theorem 6.3. *Let $X = X(a_1, a_2, a_3, a_4)$ be a Kollár surface with $w^* > 1$. Then the following are equivalent:*

- (a) $p_g(X) = 0$.
- (b) $a_i \equiv 1$ or $a_i a_{i+1} \equiv -1$ modulo w^* for some i .
- (c) X is rational.

Lemma 6.4. *Let $0 < a < n$ be relatively prime. Then:*

- (1) $s(1, 1; n) > 2s(1, a; n)$ if $a \not\equiv 1$.
- (2) $s(1, 1; n) > 3s(1, a; n)$ if $a \not\equiv 1, 2, 2^{-1}$.
- (3) $s(1, 1; n) > 4s(1, a; n)$ if $a \not\equiv 1, 2, 2^{-1}, 3, 3^{-1}$.

Proof. First of all, using the reciprocity law we have

$$\begin{aligned} 2s(1, 2; n) &= \frac{n^2 - 6n + 5}{12n} < s(1, 1; n), \\ 3s(1, 3; n) &\leq \frac{n^2 - 7n + 10}{12n} < s(1, 1; n), \\ 4s(1, 4; n) &\leq \frac{n^2 - 6n + 17}{12n} < s(1, 1; n) \end{aligned}$$

with $\gcd(n, 2) = 1$, $\gcd(n, 3) = 1$, and $\gcd(n, 4) = 1$, respectively, and $n \geq 6$. Notice that $s(1, 1; n) = (n - 1)(n - 2)/12n$. Girstmair [2017, Theorem 1] describes how Dedekind sums $s(1, m; n)$ grow for a fixed m , given a positive integer k . To do so, Girstmair divides the numbers $1 \leq m \leq n - 1$ as ordinary and not ordinary, and proves that, if m is ordinary, then $s(1, m; n) \leq n/(12(k + 1)) + O(1)$ and, if m is not ordinary, then there exist $d \in \{1, \dots, 2k + 1\}$ and $c \in \{0, 1, \dots, d\}$, $\gcd(c, d) = 1$, such that $s(1, m; n) = n/(12dq) + O(1)$, where $q = md - nc$.

First assume that $k = 2$. Notice that $s(1, 1; n)/2 = n/24 + O(1)$; also if m is ordinary, then $s(1, m; n) \leq n/36 + O(1)$, and if m is not ordinary and $dq \geq 3$, then $s(1, m; n) \leq n/36 + O(1)$. Therefore, we have to find a bound for the three $O(1)$ involved, and find an N such that, if $n > N$, then $s(1, 1; n)/2 > s(m, n)$ for ordinary numbers and nonordinary numbers with $qd \geq 3$. The procedure to do so is shown by

Girstmair [2017, Theorem 2], and for the case $k = 2$ such N is 132. The nonordinary numbers with $qd \leq 2$ correspond to $m \equiv 1, 2, 2^{-1}$, but the first case was ruled out in the proposition, and the inequality for 2 and 2^{-1} was shown at the beginning of the proof. Therefore, we have (1) for $n > 132$, and using a computer we can check that it holds true for every n .

For $k = 3$ and $k = 4$ we obtain similar results, with $N = 320$ and $N = 630$, respectively. The cases with $qd \leq 3$ and $qd \leq 4$ are the ones ruled out in the proposition, and using a computer we can check that (2) and (3) are true for $n \leq 320$ and $n \leq 630$. □

Corollary 6.5. (1) $2s(1, 1; n) - 2s(1, 2; n) + s(1, 4; n) - s(1, 3; n) + s(1, 2 \cdot 3^{-1}; n) - s(1, 4 \cdot 3^{-1}; n) > 0$
for all $n > 5$.

(2) $2s(1, 1; n) - s(1, 2; n) - s(1, 3; n) - s(1, 4; n) + s(1, 6; n) - s(1, 2 \cdot 3^{-1}; n) + s(1, 4 \cdot 3^{-1}; n) > 0$
for all $n > 7$.

(3) $2s(1, 1; n) - s(1, 2; n) - s(1, 3; n) - s(1, 5; n) + s(1, 6; n) + s(1, 2 \cdot 5^{-1}; n) - s(1, 6 \cdot 5^{-1}; n) > 0$
for all $n > 7$.

Proof. Using the inequalities from Lemma 6.4 we see that to prove (1) it is enough to prove that $\frac{2}{3}s(1, 1; n) + s(1, 4; n) + s(1, 2 \cdot 3^{-1}; n) - s(1, 4 \cdot 3^{-1}; n) > 0$. On the other hand, we have that $s(1, 4; n) > 0$ if $n \notin \{7, 13, 19, 25, 31\}$, $s(1, -2 \cdot 3^{-1}; n) < s(1, 1; n)/3$ if $n \notin \{5, 7\}$, and $s(1, 4 \cdot 3^{-1}; n) < s(1, 1; n)/3$ if $n \neq 5$. Therefore, if n is not one of those cases, then the inequality holds. We check the remaining cases and find that (1) is false only if $n = 5$. We repeat the same argument and prove that we have to check the cases when $n \in \{7, 11, 13, 19, 25, 31\}$ for (2), and when $n \in \{7, 13, 19, 31\}$ for (3). Both cases give us that (2) or (3) are false only if $n = 7$. □

Proof of Theorem 6.3. By Corollary 5.7, we have that the geometric genus of $X(a_1, a_2, a_3, a_4)$ is

$$p_g(X) = 2s(1, 1; w^*) - \sum_{i=1}^4 s(1, a_i; w^*) + s(1, a_1 a_4; w^*) + s(1, a_1 a_2; w^*).$$

(c) \implies (a). This is trivial.

(a) \implies (b). Assume that $a_i \not\equiv 1$ and $a_i a_{i+1} \not\equiv -1$ for all i . First, if $a_i \not\equiv 2, 2^{-1}$ and $a_i a_{i+1} \not\equiv -2, -2^{-1}$ for all i , then by Lemma 6.4(2) we have that $p_g > 2s(1, 1; w^*) - \frac{6}{3}s(1, 1; w^*) > 0$. Therefore, it is enough to rule out the cases when $a_1 \equiv 2$ or $a_1 a_2 \equiv -2^{-1}$. First suppose that $a_1 \equiv 2$, so

$$p_g = 2s(1, 1; w^*) + s(1, 2a_2; w^*) + s(1, 2a_4; w^*) - s(1, 2; w^*) - \sum_{i=2}^4 s(1, a_i; w^*),$$

and we have to check the cases when we cannot use Lemma 6.4(3).

If $a_3 \equiv 2$ or $a_3 \equiv 2^{-1}$, then $a_1 a_2 \equiv -1$ or $a_4 \equiv 1$, respectively, so they satisfy the hypothesis for $p_g = 0$.

If $a_2 \equiv 2^{-1}$, $2a_2 \equiv -2$, $2a_4 \equiv -2$, $a_4 \equiv 3^{-1}$, or $2a_2 \equiv -3$, then one of the terms is equal to $s(1, 1; w^*)$ or two of the terms cancel, so by Lemma 6.4(1) we have that $p_g > 0$.

If $a_2 \equiv 2$, $2a_2 \equiv -2^{-1}$, or $2a_4 \equiv -2^{-1}$, then

$$p_g = 2s(1, 1; w^*) - 2s(1, 2; w^*) + s(1, 4; w^*) - s(1, 3; w^*) + s(1, 2 \cdot 3^{-1}; w^*) - s(1, 4 \cdot 3^{-1}; w^*)$$

and by Corollary 6.5(1) $p_g > 0$ when $w^* > 5$. If $w^* = 5$, then it satisfies the conditions for $p_g = 0$.

If $a_2 \equiv 3$ or $2a_4 \equiv -3^{-1}$, then

$$p_g = 2s(1, 1; w^*) - s(1, 2; w^*) - s(1, 3; w^*) - s(1, 4; w^*) + s(1, 6; w^*) - s(1, 2 \cdot 3^{-1}; w^*) + s(1, 4 \cdot 3^{-1}; w^*)$$

and by Corollary 6.5(2) $p_g > 0$ when $w^* > 7$. If $w^* = 7$, then it satisfies the conditions for $p_g = 0$.

If $a_4 \equiv 3$ or $2a_2 \equiv -3^{-1}$, then

$$p_g = 2s(1, 1; w^*) - s(1, 2; w^*) - s(1, 3; w^*) - s(1, 5; w^*) + s(1, 6; w^*) + s(1, 2 \cdot 5^{-1}; w^*) - s(1, 6 \cdot 5^{-1}; w^*)$$

and by Corollary 6.5(3) $p_g > 0$ when $w^* > 7$. If $w^* = 7$, then it satisfies the conditions for $p_g = 0$.

These cover all the cases for $a_1 \equiv 2$. Now assume that $a_1 a_2 \equiv -2^{-1}$, so

$$p_g = 2s(1, 1; w^*) - s(1, 2; w^*) + s(1, a_1 a_4; w^*) + s(1, 2a_2; w^*) - \sum_{i=2}^4 s(1, a_i; w^*),$$

and we proceed as in the previous case.

If $a_1 a_4 \equiv -2$ or $a_1 a_4 \equiv -2^{-1}$, then $a_1 \equiv 1$ or $a_4 \equiv 1$, respectively, so they satisfy the hypothesis for $p_g = 0$.

If $a_2 \equiv 3^{-1}$ or $a_3 \equiv 3$, then two of the terms in the sum cancel, so by Lemma 6.4(1) we have that $p_g > 0$.

If $a_4 \equiv 3^{-1}$ or $2a_2 \equiv -3^{-1}$, then

$$p_g = 2s(1, 1; w^*) - s(1, 2; w^*) - s(1, 3; w^*) - s(1, 4; w^*) + s(1, 6; w^*) - s(1, 2 \cdot 3^{-1}; w^*) + s(1, 4 \cdot 3^{-1}; w^*)$$

and by Corollary 6.5(2) $p_g > 0$ when $w^* > 7$. If $w^* = 7$, then it satisfies the conditions for $p_g = 0$.

If $a_2 \equiv 3$ or $a_3 \equiv 3^{-1}$, then

$$p_g = 2s(1, 1; w^*) - s(1, 2; w^*) - s(1, 3; w^*) - s(1, 5; w^*) + s(1, 6; w^*) + s(1, 2 \cdot 5^{-1}; w^*) - s(1, 6 \cdot 5^{-1}; w^*)$$

and by Corollary 6.5(3) $p_g > 0$ when $w^* > 7$. If $w^* = 7$, then it satisfies the conditions for $p_g = 0$.

These cover all the cases for $a_1 a_2 \equiv -2^{-1}$.

(b) \implies (c). Notice that (b) implies the existence of μ_i and μ_j such that $\mu_i + \mu_j \equiv 0 \pmod{w^*}$. Consider the trivial pencil of lines through $L_i \cap L_j$. Since $\mu_i + \mu_j \equiv 0 \pmod{w^*}$, this pencil defines a pencil of smooth rational curves in Y via pull-back. Therefore, Y is rational, and so is X . \square

6.2. $p_g = 1$ surfaces are K3. In Table 1, we show the total transform of the key configuration of curves after successively blowing down several (-1) -curves from the minimal resolution of the indicated surfaces $X(a_1, a_2, a_3, a_4)$.

$X(a_1, a_2, a_3, a_4)$	w^*	total transform of key configuration
$X(7, 7, 15, 15)$	4	
$X(8, 9, 14, 22)$	5	
$X(11, 27, 10, 18)$	7	
$X(17, 14, 42, 18)$	11	
$X(20, 21, 43, 22)$	13	
$X(26, 56, 39, 64)$	17	
$X(29, 30, 42, 32)$	19	
$X(47, 51, 63, 91)$	20	

Table 1. List for $p_g = 1$.

Theorem 6.6. *Let $X = X(a_1, a_2, a_3, a_4)$ be a Kollár surface with $w^* > 1$. Then the following are equivalent:*

- (a) $p_g(X) = 1$.
- (b) X is birational to one of the eight surfaces in Table 1.
- (c) X is birational to a K3 surface.

Proof. (c) \implies (a). It is trivial.

(a) \implies (b). First we prove:

Lemma 6.7. *Let m be a positive integer. Then there is a positive integer N such that, if $w^* > N$ and $p_g \neq 0$, then $p_g > m$.*

Proof. If all a_i and $-a_1a_2$ and $-a_1a_4$ are not equivalent to $2, 2^{-1}, 3, 3^{-1}$, then by Lemma 6.4(3)

$$p_g > 2s(1, 1; w^*) - \frac{6}{4}s(1, 1; w^*) = \frac{1}{2}s(1, 1; w^*).$$

Also we note that, if we fix two of these values, say for example $a_1 \equiv 2$ and $a_1a_2 \equiv -3$, then the rest of the a_i are completely determined, and they are equivalent to $2, 2^{-1}, 3, 3^{-1}$ only for finitely many w^* . Therefore, if we set two of the $a_i, -a_1a_2$, or $-a_1a_4$ to be equivalent to 3 or 3^{-1} , then for $w^* \gg 0$

$$p_g > 2s(1, 1; w^*) - \frac{2}{3}s(1, 1; w^*) - s(1, 1; w^*) = \frac{1}{3}s(1, 1; w^*).$$

If one of the values is 2 or 2^{-1} and the other is 3 or 3^{-1} , then for $w^* \gg 0$

$$p_g > 2s(1, 1; w^*) - \frac{1}{2}s(1, 1; w^*) - \frac{1}{3}s(1, 1; w^*) - s(1, 1; w^*) = \frac{1}{6}s(1, 1; w^*).$$

Both of these cases happen when $w^* > 28$; hence, we have to check the case when two of the values are 2 or 2^{-1} . This was done in the proof of Theorem 6.3, and the only relevant case is when p_g is $2s(1, 1; w^*) - 2s(1, 2; w^*) + s(1, 4; w^*) - s(1, 3; w^*) + s(1, 2 \cdot 3^{-1}; w^*) - s(1, 4 \cdot 3^{-1}; w^*)$. For $w^* \gg 0$

$$p_g > 2s(1, 1; w^*) - s(1, 1; w^*) - \frac{1}{3}s(1, 1; w^*) - \frac{1}{2}s(1, 1; w^*) + s(1, 4; w^*),$$

and because $s(1, 4; w^*) \geq 0$ for $w^* \geq 15$, we have that $p_g > s(1, 1; w^*)/6$.

Therefore, N is the first integer such that $s(1, 1; N) > 6m$. □

To prove this implication, we first use Lemma 6.7 for $m = 1$, which gives us that $N = 75$. We check using a computer all the possible w^* -th root covers for $w^* \leq 75$, and find that there are eight cases with $p_g = 1$, which are represented by a Kollár surface in Table 1.

(b) \implies (c). We prove this implication by means of the following simple lemma:

Lemma 6.8. *Let S be a smooth projective surface with $p_g = 1$ and $q = 0$. Assume it has an effective connected divisor F with $F^2 = 0$ and $p_a(F) = 1$, and a (-2) -curve C such that $F \cdot C = 1$. Then S is birational to a K3 surface, and F is a fiber of an elliptic fibration $S \rightarrow \mathbb{P}^1$, where C is a section.*

Proof. Notice that F has the type of a nonmultiple fiber of an elliptic fibration. We want to get such a fibration on S . By the Riemann–Roch inequality and $F \cdot (F - K_S) = 0$, we have $h^0(F) + h^2(F) \geq \chi(\mathcal{O}_S) = 2$. Since in addition $h^2(F) = h^0(K_S - F)$ and $C \cdot (K_S - F) = -1$, we have $h^2(F) = 0$. Therefore, there is a fibration $S \rightarrow \mathbb{P}^1$ with general fiber of genus 1 and F is a fiber. Let S' be the relative minimal model of this fibration. By the canonical class formula, $K_S \sim (-2 + \chi(\mathcal{O}_S))F + \sum_i (m_i - 1)G_i + E$ where G_i are the multiple fibers, and E is the exceptional divisor from $S \rightarrow S'$. But there is a section C , and so $G_i = 0$ for all i . Then S' has trivial canonical class, and so it is a K3 surface. \square

We now go case by case, showing what the support $\text{supp}(F)$ of F is and its type (using Kodaira's notation), and showing C . Here we are choosing F and C ; there are other choices in general:

$$(4) \text{supp}(F) = \sum_{i=1}^6 F_i + L_1 + L_2 + L_4 + F_{16} + F_{17} + F_{18}, \text{ type I}_{12}, \text{ and } C = F_7.$$

$$(5) \text{supp}(F) = F_1 + F_{16} + F_{17} + L_4, \text{ type IV, and } C = F_2.$$

$$(7) \text{supp}(F) = F_1 + F_{16} + F_{17} + L_4, \text{ type III, and } C = F_{15}.$$

$$(11) \text{supp}(F) = F_6 + L_2 + F_{17} + F_7, \text{ type II, and } C = F_5.$$

$$(13) \text{supp}(F) = F_1 + F_2 + L_4 + L_3 + F_8 + \sum_{i=10}^{15} F_i, \text{ type III}^*, \text{ and } C = F_3.$$

$$(17) \text{supp}(F) = L_2 + \sum_{i=7}^9 F_i + F_{12} + L_3 + F_{13} + F_{16}, \text{ type IV, and } C = F_{11}.$$

$$(19) \text{supp}(F) = F_4 + L_1 + F_5 + F_6 + F_7 + L_2 + F_{15}, \text{ type II, and } C = F_3.$$

$$(20) \text{supp}(F) = F_3 + L_1 + F_4 + F_5 + F_6 + L_2 + F_{14}, \text{ type II, and } C = F_2. \quad \square$$

6.3. $p_g \geq 2$ generic surfaces are of general type. In this subsection, we assume that $p_g \geq 2$. We recall that Kollár surfaces are simply connected. By classification of algebraic surfaces, the Kodaira dimension of the associate surface Y is either 1 or 2. We first present families of explicit examples for each of the two possible Kodaira dimensions, and then we show the general picture for $w^* \gg 0$.

Let $g : Y' \rightarrow \mathbb{P}^2$ be the normal w^* -th root cover branched on

$$(L_1^{\mu_1} L_2^{\mu_2} L_3^{\mu_3} L_4^{\mu_4} = 0),$$

and let $f : Y \rightarrow \mathbb{P}^2$ be g composed with the minimal resolution of singularities of Y' . Let $p_{i,j} = L_i \cap L_j$ for $i < j$. Let $E_{i,j,k}$ be the k -th exceptional curve over $p_{i,j}$. Then

$$K_Y \equiv f^* \left(-3H + \frac{w^* - 1}{w^*} (L_1 + L_2 + L_3 + L_4) \right) - \sum_{i < j} \sum_k \left(1 - \frac{\alpha_{i,j,k} + \beta_{i,j,k}}{w^*} \right) E_{i,j,k}$$

where H is a line in \mathbb{P}^2 . We have

$$-3H + \frac{w^* - 1}{w^*} (L_1 + L_2 + L_3 + L_4) \equiv \frac{w^* - 4}{4w^*} (L_1 + L_2 + L_3 + L_4)$$

and

$$f^*(L_i + L_j) \equiv w^* L'_i + w^* L'_j + \sum_k (\alpha_{i,j,k} + \beta_{i,j,k}) E_{i,j,k}$$

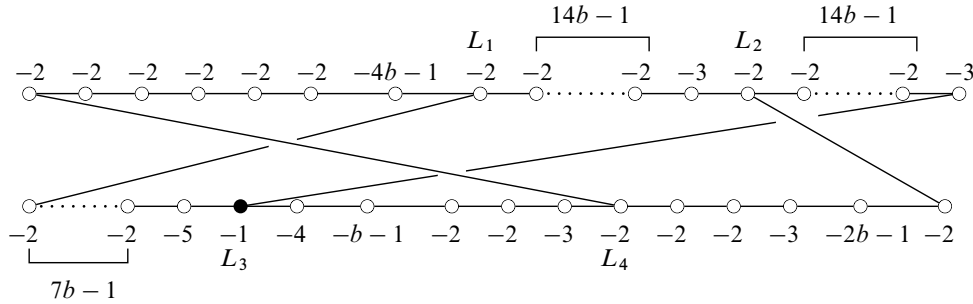

Figure 10. Curve configuration of a general type example.

for $i \neq j$, and so

$$K_Y \equiv \frac{w^* - 4}{4} (L'_1 + L'_2 + L'_3 + L'_4) + \sum_{i < j} \sum_k \left(\frac{\alpha_{i,j,k} + \beta_{i,j,k} - 4}{4} \right) E_{i,j,k},$$

where we are using notation and facts from the beginning of Section 3, and $L'_i \simeq \mathbb{P}^1$ is the (reduced, irreducible) preimage of L_i .

Example 6.9. Let $b \geq 2$. Consider $w^* = 4(b - 1)$, $\mu_1 = \mu_2 = 1$, and $\mu_3 = \mu_4 = 2b - 3$. Then, over $p_{1,2}$ and $p_{3,4}$ we have A_{w^*-1} singularities in Y' , and over the rest of the $p_{i,j}$ we have $\frac{1}{w^*}(1, 2b - 1)$. Notice that $w^*/(2b - 1) = [2, b, 2]$. We have that $L_i'^2 = -2$, and

$$K_Y \equiv \frac{b - 2}{2} \left(2 \sum_i L'_i + \sum_k 2(E_{1,2,k} + E_{3,4,k}) + (E_{1,3,k} + E_{1,4,k} + E_{2,3,k} + E_{2,4,k}) \right).$$

Therefore, Y is a minimal surface with $K_Y^2 = 0$ and $e(Y) = 3w^* + 12$, and so $p_g(Y) = b - 1$. The surface Y is K3 when $b = 2$, and Kodaira dimension 1 when $b > 2$. In fact, one can show that $E_{1,3,2}, E_{1,4,2}, E_{2,3,2}, E_{2,4,2}$ are sections (and $(-b)$ -curves) for an elliptic fibration $Y \rightarrow \mathbb{P}^1$, and the complement of them in the support above of K_Y give two $I_{w^*}^*$ singular fibers (using Kodaira notation).

Example 6.10. Let $b \geq 1$. Consider $w^* = 28b + 1$, $\mu_1 = 1$, $\mu_2 = 2$, $\mu_3 = 4$, and $\mu_4 = 28b - 6$. Then over $p_{i,j}$ we have:

- $(p_{1,2})$ $\frac{1}{w^*}(1, w^* - 2)$ and $[2, \dots, 2, 3]$ with $(14b - 1)$ 2s.
- $(p_{1,3})$ $\frac{1}{w^*}(1, 7b)$ and $[5, 2, \dots, 2]$ with $(7b - 1)$ 2s.
- $(p_{1,4})$ $\frac{1}{w^*}(1, 7)$ and $[4b + 1, 2, 2, 2, 2, 2, 2]$.
- $(p_{2,3})$ $\frac{1}{w^*}(1, w^* - 2)$ and $[2, \dots, 2, 3]$ with $(14b - 1)$ 2s.
- $(p_{2,4})$ $\frac{1}{w^*}(1, 14b + 4)$ and $[2, 2b + 1, 3, 2, 2]$.
- $(p_{3,4})$ $\frac{1}{w^*}(1, 7b + 2)$ and $[4, b + 1, 2, 2, 3]$.

One can also compute that $L_1'^2 = L_2'^2 = L_4'^2 = -2$ and $L_3'^2 = -1$. The configuration of all these curves is shown in Figure 10.

One can verify that $\alpha_{i,j,k} + \beta_{i,j,k} > 4$ for all i, j, k . Therefore, by the formula above, K_Y can be written with positive coefficients supported in the configuration of curves, so that to obtain the minimal model Y'' of Y we only need to contract L'_3 since $(w^* - 4)/4 > 1$ (and see the figure). We compute using the formulas above $K_{Y''}^2 = 7(3b - 1)$, $e(Y'') = 63b + 19$, and $p_g(Y'') = 7b$. In this way, Y'' is of general type for any b .

We now consider prime numbers $w^* \gg 0$ and partitions

$$\mu_1 + \mu_2 + \mu_3 + \mu_4 = w^*$$

with $0 < \mu_i < w^*$. Let \mathcal{S} be the set of all partitions. Then, as we did before, there are smooth projective surfaces Y constructed as w^* -th root covers $Y \rightarrow Y' \rightarrow \mathbb{P}^2$, and there are infinitely many Kollár surfaces $X(a_1, a_2, a_3, a_4)$ birational to each Y . Let X_{\min} be a minimal (smooth) model for Y (and so for all $X(a_1, a_2, a_3, a_4)$). The following is based on [Urzúa 2010; 2017]:

Theorem 6.11. *There is $\mathcal{S}' \subset \mathcal{S}$ with $|\mathcal{S}'|/w^* \rightarrow 0$ as $w^* \gg 0$ such that, if $\{\mu_1, \mu_2, \mu_3, \mu_4\} \in \mathcal{S} \setminus \mathcal{S}'$, then X_{\min} is a simply connected surface of general type with $K_{X_{\min}}^2/e(X_{\min}) \rightarrow 1$ as $w^* \gg 0$.*

Proof. By Proposition 5.6, we have $e(Y) = w^* + 2 + \sum_{i < j} l(\mu_i, \mu_j; w^*)$, and

$$K_Y^2 = w^* + \frac{4}{w^*} + 4 + \sum_{i < j} 12s(\mu_i, \mu_j; w^*) - l(\mu_i, \mu_j; w^*).$$

Notice that by Theorem 4.1 in [Urzúa 2017], both $e(Y) \gg 0$ and $K_Y^2 \gg 0$. In particular Y is of general type by classification of algebraic surfaces. We also note that $K_{Y'}$ is ample since it is numerically $(1 - 4/w^*)$ times the pull-back of the class of a line. Thus, by Theorem 4.3 in [Urzúa 2017], the number of potential (-1) -curves to be contracted over w^* tends to zero as w^* approaches infinity, and so X_{\min} satisfies $K_{X_{\min}}^2/e(X_{\min}) \rightarrow 1$ as $w^* \gg 0$. \square

Acknowledgements

We are grateful to DongSeon Hwang for numerous discussions about \mathbb{Q} HPPs, to Kurt Girstmair for useful discussions on Dedekind sums, and to the anonymous referees for their many helpful comments. This is part of the master's thesis of the second author at the Pontificia Universidad Católica de Chile. A large part of this paper was written while the authors were visiting the Department of Mathematics of the University of Massachusetts Amherst. We are thankful for the hospitality. The authors were supported by the FONDECYT regular grant 1150068.

References

- [Barkan 1977] P. Barkan, "Sur les sommes de Dedekind et les fractions continues finies", *C. R. Acad. Sci. Paris Sér. A-B* **284**:16 (1977), A923–A926. MR Zbl
- [Barth et al. 2004] W. P. Barth, K. Hulek, C. A. M. Peters, and A. Van de Ven, *Compact complex surfaces*, 2nd ed., *Ergebnisse der Mathematik und ihrer Grenzgebiete (3)* **4**, Springer, 2004. MR Zbl

- [Dolgachev 1982] I. Dolgachev, “Weighted projective varieties”, pp. 34–71 in *Group actions and vector fields* (Vancouver, 1981), edited by J. B. Carrell, Lecture Notes in Mathematics **956**, Springer, 1982. MR Zbl
- [Esnault and Viehweg 1992] H. Esnault and E. Viehweg, *Lectures on vanishing theorems*, DMV Seminar **20**, Birkhäuser, 1992. MR Zbl
- [Girstmair 2017] K. Girstmair, “The largest values of Dedekind sums”, *Int. J. Number Theory* **13**:6 (2017), 1579–1583. MR Zbl
- [Gonzalez-Sprinberg and Lejeune-Jalabert 1997] G. Gonzalez-Sprinberg and M. Lejeune-Jalabert, “Families of smooth curves on surface singularities and wedges”, *Ann. Polon. Math.* **67**:2 (1997), 179–190. MR Zbl
- [Hirzebruch and Zagier 1974] F. Hirzebruch and D. Zagier, *The Atiyah–Singer theorem and elementary number theory*, Mathematics Lecture Series **3**, Publish or Perish, 1974. MR Zbl
- [Hwang and Keum 2012] D. Hwang and J. Keum, “Construction of singular rational surfaces of Picard number one with ample canonical divisor”, *Proc. Amer. Math. Soc.* **140**:6 (2012), 1865–1879. MR Zbl
- [Iano-Fletcher 2000] A. R. Iano-Fletcher, “Working with weighted complete intersections”, pp. 101–173 in *Explicit birational geometry of 3-folds*, edited by A. Corti and M. Reid, London Mathematical Society Lecture Note Series **281**, Cambridge University, 2000. MR Zbl
- [Kollár 2008] J. Kollár, “Is there a topological Bogomolov–Miyaoaka–Yau inequality?”, *Pure Appl. Math. Q.* **4**:2 (2008), 203–236. MR Zbl
- [Reid 2003] M. Reid, “Surface cyclic quotient singularities and Hirzebruch–Jung resolutions”, preprint, 2003, Available at <http://homepages.warwick.ac.uk/~masda/surf/more/cyclic.pdf>.
- [Urzúa 2010] G. Urzúa, “Arrangements of curves and algebraic surfaces”, *J. Algebraic Geom.* **19**:2 (2010), 335–365. MR Zbl
- [Urzúa 2017] G. Urzúa, “Chern slopes of surfaces of general type in positive characteristic”, *Duke Math. J.* **166**:5 (2017), 975–1004. MR Zbl

Communicated by Gavril Farkas

Received 2016-12-23 Revised 2018-01-29 Accepted 2018-03-17

urzua@mat.puc.cl

*Facultad de Matemáticas, Pontificia Universidad Católica de Chile,
Campus San Joaquín, Santiago, Chile*

yanez@math.utah.edu

*Department of Mathematics, University of Utah, Salt Lake City, UT,
United States*

Algebra & Number Theory

msp.org/ant

EDITORS

MANAGING EDITOR

Bjorn Poonen
Massachusetts Institute of Technology
Cambridge, USA

EDITORIAL BOARD CHAIR

David Eisenbud
University of California
Berkeley, USA

BOARD OF EDITORS

Richard E. Borcherds	University of California, Berkeley, USA	Martin Olsson	University of California, Berkeley, USA
Antoine Chambert-Loir	Université Paris-Diderot, France	Raman Parimala	Emory University, USA
J-L. Colliot-Thélène	CNRS, Université Paris-Sud, France	Jonathan Pila	University of Oxford, UK
Brian D. Conrad	Stanford University, USA	Anand Pillay	University of Notre Dame, USA
Samit Dasgupta	University of California, Santa Cruz, USA	Michael Rapoport	Universität Bonn, Germany
Hélène Esnault	Freie Universität Berlin, Germany	Victor Reiner	University of Minnesota, USA
Gavril Farkas	Humboldt Universität zu Berlin, Germany	Peter Sarnak	Princeton University, USA
Hubert Flenner	Ruhr-Universität, Germany	Joseph H. Silverman	Brown University, USA
Sergey Fomin	University of Michigan, USA	Michael Singer	North Carolina State University, USA
Edward Frenkel	University of California, Berkeley, USA	Christopher Skinner	Princeton University, USA
Andrew Granville	Université de Montréal, Canada	Vasudevan Srinivas	Tata Inst. of Fund. Research, India
Joseph Gubeladze	San Francisco State University, USA	J. Toby Stafford	University of Michigan, USA
Roger Heath-Brown	Oxford University, UK	Pham Huu Tiep	University of Arizona, USA
Craig Huneke	University of Virginia, USA	Ravi Vakil	Stanford University, USA
Kiran S. Kedlaya	Univ. of California, San Diego, USA	Michel van den Bergh	Hasselt University, Belgium
János Kollár	Princeton University, USA	Marie-France Vignéras	Université Paris VII, France
Philippe Michel	École Polytechnique Fédérale de Lausanne	Kei-Ichi Watanabe	Nihon University, Japan
Susan Montgomery	University of Southern California, USA	Shou-Wu Zhang	Princeton University, USA
Shigefumi Mori	RIMS, Kyoto University, Japan		

PRODUCTION

production@msp.org
Silvio Levy, Scientific Editor

See inside back cover or msp.org/ant for submission instructions.

The subscription price for 2018 is US \$340/year for the electronic version, and \$535/year (+\$55, if shipping outside the US) for print and electronic. Subscriptions, requests for back issues and changes of subscriber address should be sent to MSP.

Algebra & Number Theory (ISSN 1944-7833 electronic, 1937-0652 printed) at Mathematical Sciences Publishers, 798 Evans Hall #3840, c/o University of California, Berkeley, CA 94720-3840 is published continuously online. Periodical rate postage paid at Berkeley, CA 94704, and additional mailing offices.

ANT peer review and production are managed by EditFLOW[®] from MSP.

PUBLISHED BY

 **mathematical sciences publishers**
nonprofit scientific publishing

<http://msp.org/>

© 2018 Mathematical Sciences Publishers

Algebra & Number Theory

Volume 12 No. 5 2018

Semistable Chow–Hall algebras of quivers and quantized Donaldson–Thomas invariants HANS FRANZEN and MARKUS REINEKE	1001
Certain abelian varieties bad at only one prime ARMAND BRUMER and KENNETH KRAMER	1027
Characterization of Kollár surfaces GIANCARLO URZÚA and JOSÉ IGNACIO YÁÑEZ	1073
Représentations de réduction unipotente pour $SO(2n + 1)$, III: Exemples de fronts d’onde JEAN-LOUP WALDSPURGER	1107
Correspondences without a core RAJU KRISHNAMOORTHY	1173
Local topological algebraicity with algebraic coefficients of analytic sets or functions GUILLAUME ROND	1215
Polynomial bound for the nilpotency index of finitely generated nil algebras MÁTYÁS DOMOKOS	1233
Arithmetic functions in short intervals and the symmetric group BRAD RODGERS	1243
Cohomology for Drinfeld doubles of some infinitesimal group schemes ERIC M. FRIEDLANDER and CRIS NEGRON	1281



1937-0652(2018)12:5;1-C